

Safety

System operation assumes knowledge of the installation instructions. The following symbols are used in these installation instructions:

CAUTION Indicates a hazardous situation which, if not avoided, may result in minor or moderate injury.

NOTICE Indicates a situation that may result in property damage if not avoided.

▶ Indicates a user action.

i Indicates a tip for users.

Warnings

CAUTION

Connect the power supply and the display/output device according to the safety regulations for electrical equipment.

> Risk of injury due to electric shock, damage to or destruction of the sensor

NOTICE

The supply voltage must not exceed the specified limits.

> Damage to or destruction of the sensor

Avoid shocks and impacts to the sensor.

> Damage to or destruction of the sensor

Protect the sensor cable against damage.

> Failure of the measuring device

Intended Use

The eddyNCDT 3005 is designed for use in industrial and laboratory applications. It is used for displacement, distance, thickness and movement measurement and for position measuring of parts or machine components. The system must only be operated within the limits specified in the technical data. The system must be used in such a way that no persons are endangered or machines and other material goods are damaged in the event of malfunction or total failure of the system. Take additional precautions for safety and damage prevention in case of safety-related applications.

Technical Data

Sensor	DT3005-S2-x-C1	
Measuring range	2 mm	
Start of measuring range (SMR)	0.2 mm	
Resolution ¹	1 μm	
Frequency response (-3dB)	5 kHz	
Measuring rate	Analog output	75 kSa/s (16 bit)
	Digital interface	1 kSa/s (16 bit)
Linearity	< ±5 μm	
	Sensor	< 0.5 μm / K
Temperature stability ²	Sensor	< 0.5 μm / K
	Controller	< 0.5 μm / K
Temperature compensation	Sensor	+10 ... +125 °C (optional -20 ... +180 °C)
	Controller	+10 ... +60 °C (optional -20 ... +70 °C)
Sensor type	Shielded	
Min. target size (flat)	Ø 24 mm	
Target material ³	Aluminum, steel	
Supply voltage	12 ... 32 VDC	
Power consumption	0.6 W	
Analog output	0.5 ... 9.5 V	
Synchronization	with LF & HF variants	
Connection	Sensor: integrated cable, length 1 m, min. bending radius 20 mm	
	Supply/signal: 5-pin M12 connector (see accessories for cables)	
Temperature range	Storage	-20 ... +80 °C
	Operation	Sensor: -20 ... +125 °C (optional -20 ... +180 °C), Controller: -20 ... +70 °C
Pressure resistance	10 bar (sensor, cable and controller on the front), controller on the rear IP67 (plugged in)	
Shock (DIN EN 60068-2-27)	15 g / 6 ms in 3 axes, 2 directions and 1000 shocks each	
Vibration (DIN EN 60068-2-6)	5 g / 10 ... 500 Hz in 3 axes, 2 directions and 10 cycles each	
Protection class (DIN EN 60529)	IP67	
Weight ⁴	approx. 75 g	

- 1) RMS noise relates to mid of measuring range at a frequency response of 5 kHz
- 2) Relates to the mid of the measuring range, in the compensated temperature range
- 3) Steel: St37 steel DIN1.0037 / aluminum: AlMg3
- 4) Total weight for controller, cable and sensor

Installation and Assembly

No sharp or heavy objects should be allowed to affect the cable sheath or the sensor cable, the supply cable and the output cable.

▶ Check all plug-in connections for firm seating before starting operation.

Construction: The front part of the sensor with encapsulated coil consists of electrically non-conducting materials.

i In the radial direction metal parts in the vicinity may behave similar to the measuring object, rendering the measurement result inaccurate. Please note this by selection of material for sensor mounting and their setup.

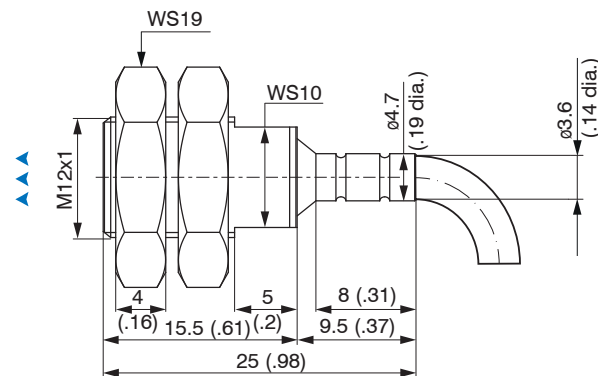

ES-S2-C-CAX, dimensions in mm (inches, rounded off)

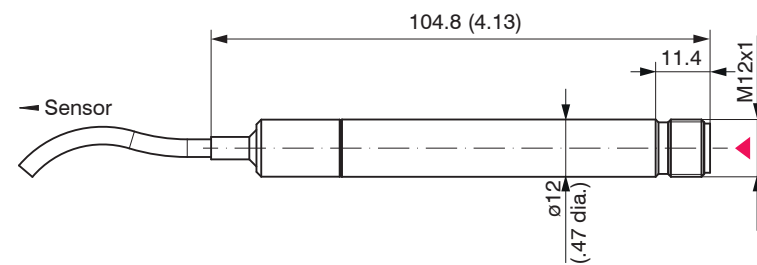

DT3005-x, dimensions in mm (inches, rounded off)

▲▲▲ Measurement direction ▲ Male connector side

Measurement Setup

Eddy current sensors generate electric fields that can overlap if the sensors are placed too close to each other (so-called cross-talk). There are two solutions to avoid this:

Mounting with Sufficient Minimum Distance

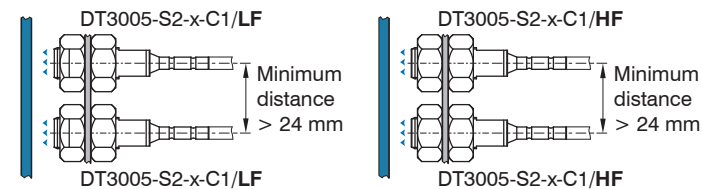

Mounting Sensors with Different Frequencies (LF / HF)

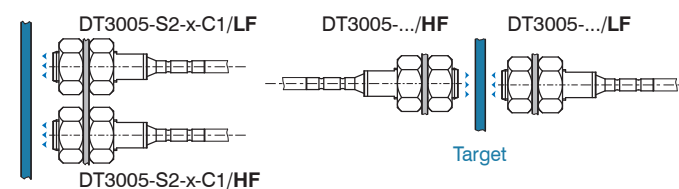

For the simultaneous operation of several eddyNCDT measuring systems, these can be supplied with a new type of frequency separation (LF/HF). The frequency separation enables multi-channel operation without mutual influence (cross-talk). This function makes a synchronization cable superfluous.

If there are more than 2 sensors, the alternating sequence LF-HF-LF-HF- ... or HF-LF-HF-LF- ... must be observed.

The choice of LF or HF sensors only affects the frequency of the electric field and has no effect on the accuracy, max. frequency response or measuring rate of the controller.



Setup Guide
eddyNCDT 3005
DT3005-S2-x-C1



Measuring Range and Output Characteristics

For each sensor a minimum distance to the target (measuring object) must be maintained. This avoids a measurement uncertainty due to the sensor pressing on the measuring object and mechanical damage to the sensor/measuring object. Start of measuring range (SMR) of DT3005-S2-x-C1 is 0.2 mm.

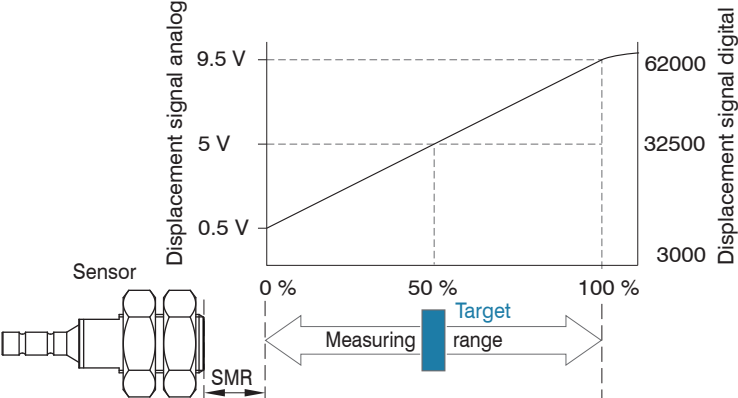

Start of measuring range (SMR), the shortest distance between the front surface of the sensor and the target.

Pin Assignment

DT3005-x	PCx/5-M12	Color
1	+ 24 V supply	Brown
2	Displacement signal	White
3	GND	Blue
4	RS485 A / +	Black
5	RS485 B / -	Gray

Installation Conditions

The relative size of the measuring object to the sensor has effects on the linearity deviation for eddy current sensors. Ideally, the measuring object size is at least 2 times the sensor diameter.

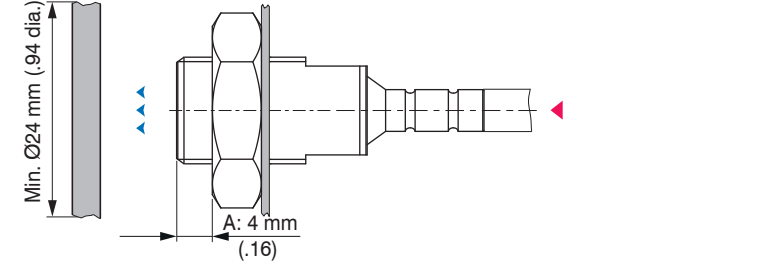

Mounting, dimensions in mm (inches, rounded off)

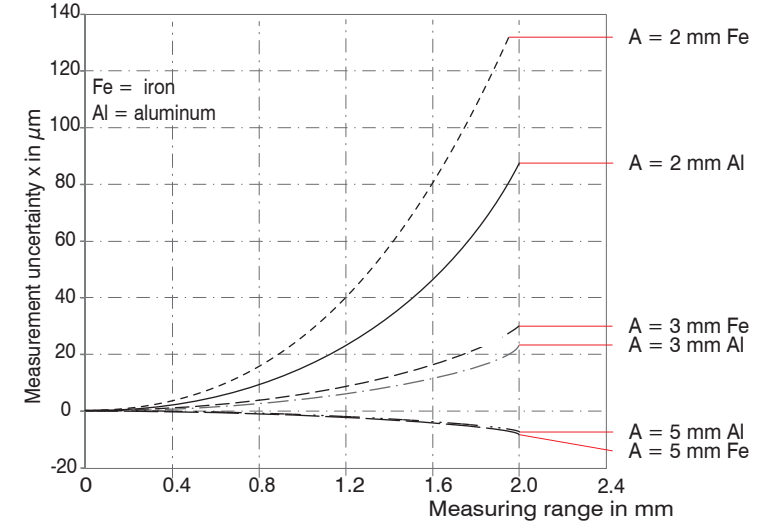

Measurement uncertainty depending on distance A and target material

Digital Interfaces

The DT3005 can be connected to fieldbuses or PCs via various interface modules using the sensorTOOL software. You can find detailed information on this at: <https://www.micro-epsilon.com/download-file/man--eddyNCDT-3005-interfaces--en.pdf>

Connection to PROFINET, EtherCAT, Ethernet/IP via IF2035
Up to 32 sensors can be connected to common fieldbuses (PROFINET, EtherCAT, Ethernet/IP) via the optionally available IF2035 interface module.

Use the sensorTOOL software, for example, to assign unique bus addresses before operating several DT3005 controllers on an IF2035. Direct address assignment via field bus is not possible.

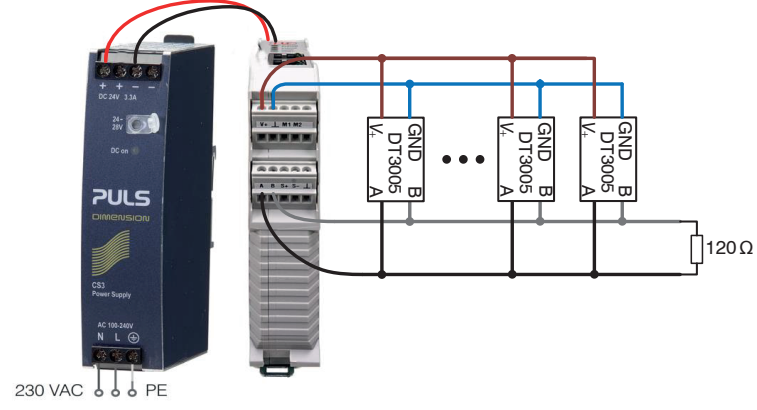

Connection of the eddyNCDT 3005 controller to the IF2035 interface module with optional PS2020 power supply unit

Ethernet/EtherCAT Connection via IF1032/ETH
If only 1 sensor must be connected to an interface module, the optionally available IF1032/ETH offers the possibility to do so.

You can find more information about the IF2035 and IF1032/ETH interface modules in the operating instructions. They are available online at: <https://www.micro-epsilon.com/industry-sensors/interfaces/if2035-for-industrial-ethernet/>

<https://www.micro-epsilon.com/fileadmin/download/manuals/man--IF1032-ETH--en.pdf>

Connection to PC and sensorTOOL

Connect a maximum of 125 eddyNCDT 3005 controllers with a USB-to-RS485 converter to a free USB port on your PC and connect the power supply unit to the eddyNCDT 3005.

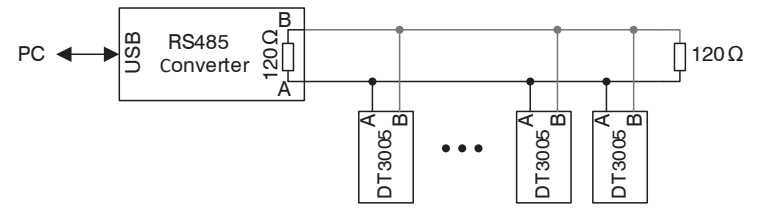

Connection of the eddyNCDT 3005 to the PC using a USB/RS485 converter

With sensorTOOL, you have software at your disposal with which you can set, visualize and document the sensor.

You can find this program online at <https://www.micro-epsilon.com/download/software/sensorTOOL.exe>.

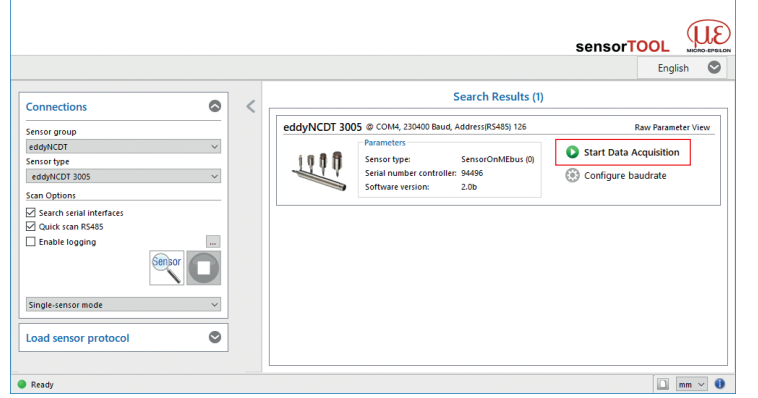

Further information on the interface module and the sensorTOOL software can be found in the interface instructions <https://www.micro-epsilon.com/download-file/man--eddyNCDT-3005-interfaces--en.pdf>.

Optional Accessories

Name	Description	Article no.
Clamping flange 12 mm		0801058
PC5/5-M12	Supply/output cable, 5 m long	2901752
PC10/5-M12	Supply/output cable, 10 m long	29011116
PC20/5-M12	Supply/output cable, 20 m long	29011178
PC5/5/90	PC5/5/90 Supply and signal cable	29011147
IF7001	IF7001 Single-channel USB/RS485 converter	2213034
IF2035-PROFINET	IF2035-PROFINET Interface module for PROFINET with DIN rail housing	2211039
IF2035-EtherCAT	IF2035-EtherCAT Interface module for EtherCAT with DIN rail housing	2211036
IF2035-EIP	IF2035-EIP Interface module for EtherNet/IP with DIN rail housing	2211038
IF1032/ETH	IF1032/ETH Interface module ME Ethernet/EtherCAT	2420066

Notes on Product Marking
The product meets the requirements of CE and UKCA. All specifications and safety instructions described in the operating instructions must be observed.

MICRO-EPSILON MESSTECHNIK GmbH & Co. KG
Koenigbacher Str. 15 • 94469 Ortenburg / Germany
Tel. +49 8542 / 168-0 • Fax +49 8542 / 168-90
info@micro-epsilon.com • www.micro-epsilon.com
Your local contact: www.micro-epsilon.com/contact/worldwide/