



Operating Instructions

capa**N**CDT 6112

CS02
CSH02
CSH02FL
CS05
CSE05
CSH05

CSH05FL
CS08
CS1
CSE1
CSH1
CSH1FL
CS1HP

CSH1,2
CSH1,2FL
CSH2FL
CSH3FL
CS2
CSH2
CSE2

CS3
CS5
CS10

Non-contact Capacitive Displacement Measuring

MICRO-EPSILON
MESSTECHNIK
GmbH & Co. KG
Königbacher Straße 15

94496 Ortenburg / Germany

Tel. +49 (0) 8542 / 168-0
Fax +49 (0) 8542 / 168-90
e-mail info@micro-epsilon.de
www.micro-epsilon.com

Contents

1.	Safety	5
1.1	Symbols Used	5
1.2	Warnings	5
1.3	Notes on CE Marking	6
1.4	Intended Use	6
1.5	Proper Environment	7
2.	Functional Principle, Technical Data	8
2.1	Measuring Principle	8
2.2	Structure	9
	2.2.1 Sensors	10
	2.2.2 Sensor Cable	12
	2.2.3 Controller	13
2.3	Technical Data	14
3.	Delivery	15
3.1	Unpacking, Included in Delivery	15
3.2	Storage	15
4.	Installation and Assembly	16
4.1	Precautionary Measures	16
4.2	Sensor	16
	4.2.1 Radial Point Clamping with Grub Screw, Cylindric Sensors	16
	4.2.2 Circumferential Clamping, Cylindric Sensors	17
	4.2.3 Flat Sensors	17
	4.2.4 Dimensional Drawings Sensors	18
4.3	Sensor Cable	24
4.4	Controller	25
4.5	Ground Connection, Earthing	25
4.6	Power Supply, Display/Output Device DT6112	26
4.7	Sensor Connection	26

5.	Operation	27
6.	Maintenance	28
7.	Liability for Material Defects.....	29
8.	Decommissioning, Disposal.....	29
Appendix		
A 1	Optional Accessories.....	30
A 2	Tilt Angle Influence on the Capacitive Sensor	32
A 3	Measurement on Narrow Targets	33
A 4	Measurements on Balls and Shafts	34

1. Safety

System operation assumes knowledge of the operating instructions.

1.1 Symbols Used

The following symbols are used in these operating instructions:



Indicates a hazardous situation which, if not avoided, may result in minor or moderate injury.



Indicates a situation that may result in property damage if not avoided.



Indicates a user action.



Indicates a tip for users.

1.2 Warnings



Disconnect the power supply before touching the sensor surface.

- > Danger of injury
- > Static discharge

Connect the power supply and the display/output device according to the safety regulations for electrical equipment.

- > Risk of injury
- > Damage to or destruction of the sensor and/or controller



Avoid shocks and impacts to the sensor and controller.

- > Damage to or destruction of the sensor and/or controller

The supply voltage must not exceed the specified limits.

- > Damage to or destruction of the sensor and/or controller

Protect the sensor cable against damage

- > Destruction of the sensor
- > Failure of the measuring device

1.3 Notes on CE Marking

The following apply to the capaNCDT 6112:

- EU directive 2014/30/EU
- EU directive 2011/65/EU, “RoHS“ category 9

Products which carry the CE mark satisfy the requirements of the EU directives cited and the European harmonized standards (EN) listed therein. The EU Declaration of Conformity is available to the responsible authorities according to EU Directive, article 10, at:

MICRO-EPSILON Messtechnik GmbH & Co. KG
Königbacher Straße 15
94496 Ortenburg / Germany

The measuring system is designed for use in industrial environments and meets the requirements.

1.4 Intended Use

- The capaNCDT 6112 measuring system is designed for use in industrial and laboratory applications. It is used for
 - measuring displacement, distance, position, movement and thickness
 - measuring the position of parts or machine components
- The system must only be operated within the limits specified in the technical data, see Chap. [2.3](#).
- The system must be used in such a way that no persons are endangered or machines and other material goods are damaged in the event of malfunction or total failure of the controller.
- Take additional precautions for safety and damage prevention in case of safety-related applications.

1.5 Proper Environment

- Protection class: IP 40
- Operating temperature:
 - Sensor: -50 ... +200 °C (-58 to +392 °F)
 - Sensor cable: -100 ... +200 °C (-58 to +392 °F) (CCmx and CCmx/90)
-20 ... +80 °C (-4 to 176 °F) (CCgx and CCgx/90 - permanently)
-20 ... +100 °C (-4 to 212 °F) (CCgx and CCgx/90 - 10,000 h)
 - Controller: +10 ... +60 °C (-50 to +140 °F)
- Humidity: 5 - 95 % (non-condensing)
- Ambient pressure: Atmospheric pressure
- Storage temperature:
 - Sensor: -50 ... +200 °C (-58 to +392 °F)
 - Sensor cable: -50 ... +200 °C (-58 to +392 °F) (CCmx and CCmx/90)
-50 ... +80 °C (-58 to +176 °F) (CCgx and CCgx/90)
 - Controller: -10 ... +75 °C (+14 to +167 °F)
- The space between the sensor surface and the target must have an unvarying dielectric constant.
- The space between the sensor surface and the target may not be contaminated (for example water, rubbed-off parts, dust, etc.).

2. Functional Principle, Technical Data

2.1 Measuring Principle

The principle of capacitive distance measurement with the capaNCDT system is based on the principle of the parallel plate capacitor. For conductive targets, the sensor and the target opposite form the two plate electrodes.

If a constant AC current flows through the sensor capacitor, the amplitude of the AC voltage at the sensor is proportional to the distance between the capacitor electrodes. The AC voltage is demodulated, amplified and output as an analog signal.

The capaNCDT system evaluates the reactance X_C of the plate capacitor which changes strictly in proportion to the distance.

$$X_C = \frac{1}{j\omega C}; \quad \text{capacitance } C = \epsilon_r * \epsilon_o * \frac{\text{area}}{\text{distance}}$$

i A small target and bent (uneven) surfaces cause a non-linear characteristic.

This theoretical relationship is realized almost ideally in practice by designing the sensors as guard ring capacitors.

The linear characteristic of the measuring signal is achieved for electrically conductive target materials (metals) without any additional electronic linearization. Slight changes in the conductivity or magnetic properties do not affect the sensitivity or linearity.

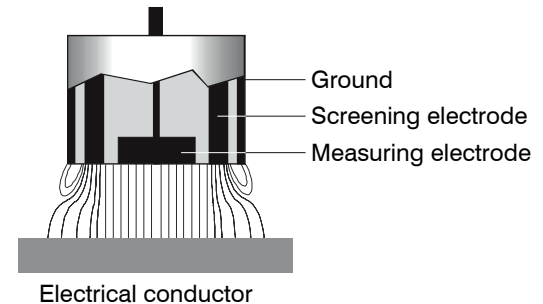

Fig. 1 Functional principle of the guard ring capacitor

2.2 Structure

The non-contact, single-channel measuring system of capaNCDT 6112, installed in an aluminum housing, consists of:

- Controller
- Sensor
- Sensor cable
- Power supply and signal cable

The signal processing electronics with oscillator, demodulator, AD converter and integrated preamplifier is in the controller.

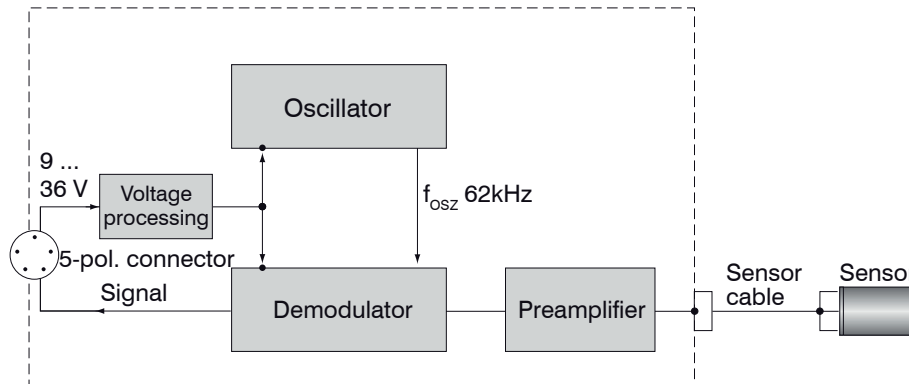

Fig. 2 Block diagram capaNCDT 6112

2.2.1 Sensors

For this measurement system, several sensors can be used.

➡ In order to obtain accurate measuring results, keep the surface of the sensor clean and free from damage.

The capacitive measuring process is area-related. A minimum area (see table) is required depending on the sensor model and measuring range. In the case of insulators the dielectric constant and the target thickness also play an important role.

Sensors for electrical conducting targets (metals)

Sensor model	Measuring range	Min. target diameter
CS02	0.2 mm	5 mm
CSH02	0.2 mm	7 mm
CSH02FL	0.2 mm	7 mm
CS05	0.5 mm	7 mm
CSE05	0.5 mm	6 mm
CSH05	0.5 mm	7 mm
CSH05FL	0.5 mm	7 mm
CS08	0.8 mm	9 mm
CS1	1 mm	9 mm
CSE1	1 mm	8 mm
CSH1	1 mm	11 mm
CSH1FL	1 mm	11 mm
CS1HP	1 mm	9 mm
CSH1,2	1.2 mm	11 mm
CSH1.FL	1.2 mm	11 mm
CSH2FL	2 mm	17 mm
CS2	2 mm	17 mm

Sensor model	Measuring range	Min. target diameter
CSH2	2 mm	17 mm
CSE2	2 mm	14 mm
CS3	3 mm	27 mm
CSH3FL	3 mm	24 mm
CS5	5 mm	37 mm
CS10	10 mm	57 mm

2.2.2 Sensor Cable

Sensor and controller are connected by a special, double screened sensor cable.

Do not shorten or lengthen these special cables.

Usually, a damaged cable can not be repaired.

NOTICE

Switch off the device when plugging and removing connectors.

Do not crush the sensor cable.

Do not modify to the sensor cable.

> Loss of functionality

Model	x = cable length	Cable ø	2 axial connector	1x axial + 1x 90°	For sensors	Min. bending radius	
						once	permanently
CCgxC	2 / 4 m	3.1 mm	•		0.05 - 0.8 mm	10 mm	22 mm
CCgxC/90	2 / 4 m	3.1 mm		•	0.05 - 0.8 mm		
CCgxB	2 / 4 m	3.1 mm	•		1 ... 10 mm		
CCgxB/90	2 / 4 m	3.1 mm		•	1 ... 10 mm		
CCmxC	1.4 / 2.8 m	2.1 mm	•		0.05 - 0.8 mm	7 mm	15 mm
CCmxC/90	1.4 / 2.8 m	2.1 mm		•	0.05 - 0.8 mm		
CCmxB	1.4 / 2.8 m	2.1 mm	•		1 ... 10 mm		
CCmxB/90	1.4 / 2.8 m	2.1 mm		•	1 ... 10 mm		

The sensors of type CSH have integrated a 1.4 long sensor cable. If necessary, cables with 2.8 m length are possible.

Other cable lengths are also available on request.

The sensor model CSE-1 (measuring range 1 mm) has the connector type C.

2.2.3 Controller

The capaNCDT 6112 contains voltage processing, oscillator, integrated preamplifier, demodulator as well as an output amplifier.

The voltage processing produces all necessary internal voltages from the power supply. The oscillator supplies the sensor with frequency and amplitude-stabilized alternating voltage. The frequency is 62 kHz. The internal preamplifier generates the distance-dependent measuring signal and amplifies it. Demodulator and output level convert the measuring signal into a standard voltage signal.

NOTICE

The output voltage can reach up to a maximum of 13 VDC when sensor is disconnected or measurement is exceeded.

> Damage to downstream devices



Fig. 3 Controller DT6112

2.3 Technical Data

Controller type	DT6112	DT6112/ECL2
Resolution static	0,01 % FSO	
Resolution dynamic	0.05 % FSO (20 kHz)	0.1 % FSO (20 kHz)
Bandwidth	20 kHz (-3 dB)	
Linearity (typical)	±0.1 % FSO	±0.2 % FSO
Max. sensitivity deviation	±0.1 % FSO	
Long term stability	< 0.05 % FSO/month	
Synchronous operation	no	
Isolator measurement	no	
Temperature stability	200 ppm	
Operating temperature, sensor	-50 ... +200 °C (-58 ... +392 °F)	
Operating temperature, controller	+10 ... +60° C (+50 ... +140 °F)	
Storage temperature	-10 ... +75° C (+14 ... +167 °F)	
Power supply	24 VDC/55 mA (9 - 36 V)	
Output	0 ... 10 V (short-circuit proof), optional: ±5 V, 10 ... 0 V	
Sensors	all sensors suitable	
CCm	1.4 m	2.8 m
CCg	2 m	4 m
Protection class	controller	IP 40
	sensors	when plugged in: IP 54
Weight	165 g	

FSO = Full Scale Output

3. Delivery



3.1 Unpacking, Included in Delivery

- 1 Controller
- 1 Power supply and output cable SCAC3/5 (DT6112)
- 1 Instruction Manual

Optional accessories:

- 1 Sensor
- 1 Sensor cable with connector
- 1 IF1032/ETH interface converter from analog (DT6112)

Further optional accessories, see Chap. [A 1](#)

-  Carefully remove the components of the measuring system from the packaging and ensure that the goods are forwarded in such a way that no damage can occur.
-  Check the delivery for completeness and shipping damage immediately after unpacking.
-  If there is damage or parts are missing, immediately contact the manufacturer or supplier.

3.2 Storage

- Storage temperature:
 - Sensor: -50 ... +200 °C (-58 to +392 °F)
 - Sensor cable: -50 ... +200 °C (-58 to +392 °F) (CCmx and CCmx/90)
-50 ... +80 °C (-58 to +176 °F) (CCgx and CCgx/90)
 - Controller: -10 ... +75 °C (+14 to +167 °F)
- Humidity: 5 - 95 % RH (non-condensing)

4. Installation and Assembly

4.1 Precautionary Measures

No sharp-edged or heavy objects may get into contact with the sensor cable sheath.

- ➡ Protect the cable against pressure loads in pressurised rooms.
- ➡ Avoid kinks in any case.
- ➡ Check the connections for tight fit.

i A damaged cable cannot be repaired.

4.2 Sensor

The sensors may be mounted free-standing or flush.

When assembling, make sure that the polished sensor surface is not scratched.

4.2.1 Radial Point Clamping with Grub Screw, Cylindric Sensors

This simple type of fixture is only recommended for a force and vibration-free installation position. The grub screw must be made of plastic so that it cannot damage or deform the sensor housing.

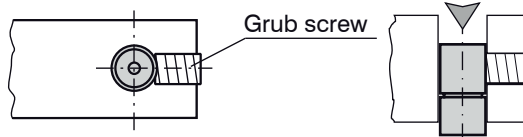

Fig. 4 Radial point clamping with grub screw

NOTICE

Do not use metal grub screws!

> Danger of damaging the sensor

4.2.2 Circumferential Clamping, Cylindric Sensors

This sensor mounting option offers maximum reliability because the sensor is clamped around its cylindrical housing. It is absolutely necessary in difficult installation environments, for example on machines, production plants et cetera.

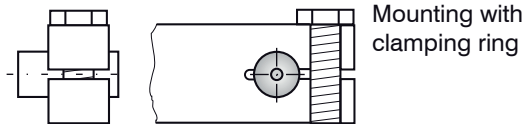

Fig. 5 Circumferential clamping

A circumferential clamping possible from 2 mm behind the front face.

i Tension at the cable is inadmissible!

4.2.3 Flat Sensors

Flat sensors are mounted by means of a tap hole for M2 (in case of sensors 0.2 and 0.5 mm) or by a through hole for M2 screws. The sensors can be bolted on top or below.

Screwing from above

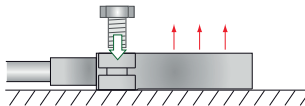

Screwing from bottom

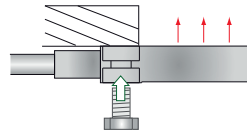

4.2.4 Dimensional Drawings Sensors

Cylindric sensors

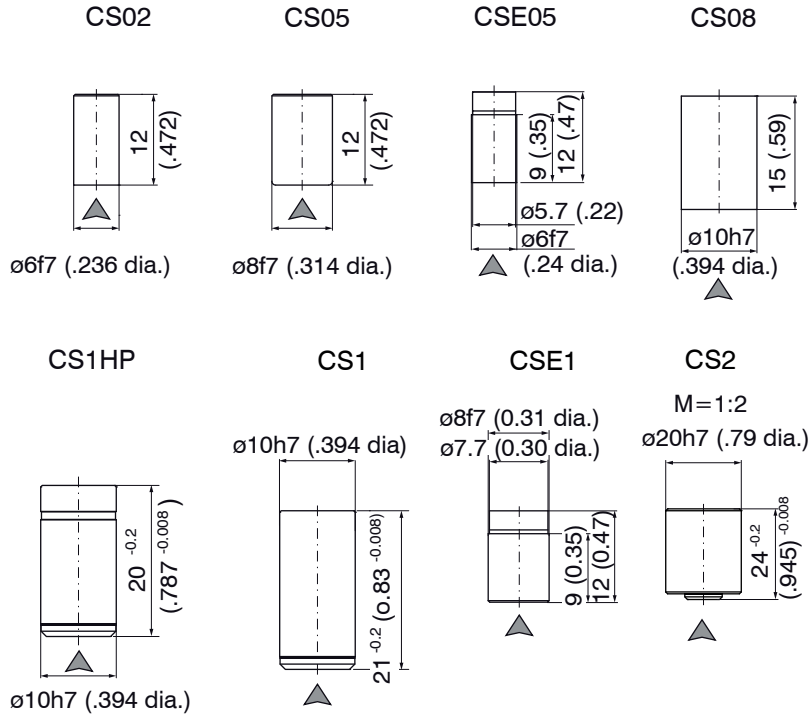

▲ Connector side

Dimensions in mm
(inches)

Circumferential clamping possible from 2 mm behind the front face.

Dimensional drawings of other sensors are available on request.

▲ Connector side

Dimensions in mm
(inches)

Circumferential clamping possible from 2 mm behind the front face.

Dimensional drawings of other sensors are available on request.

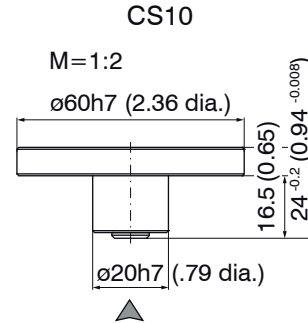
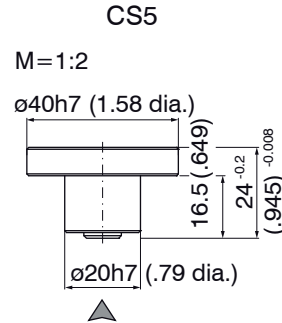
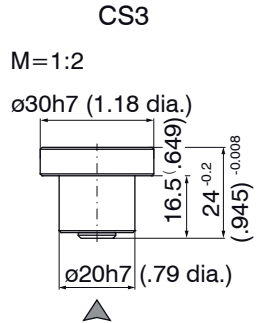

CSH02-CAMx,
CSH05-CAMx

ø8g6 (.315 dia.)

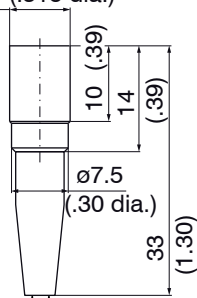

ca. 9.4 (.37)

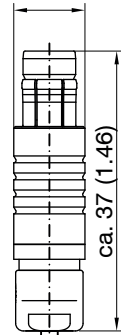

CSH1-CAMx,
CSH1.2-CAMx

ø12g6 (.473 dia.)

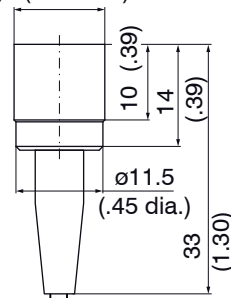

ca. 9.4 (.37)

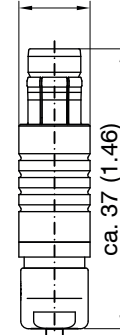

Circumferential clamp-
ing possible from 2 mm
behind the front face.

Dimensions in mm (inches), not to scale

CSH2-CAmx

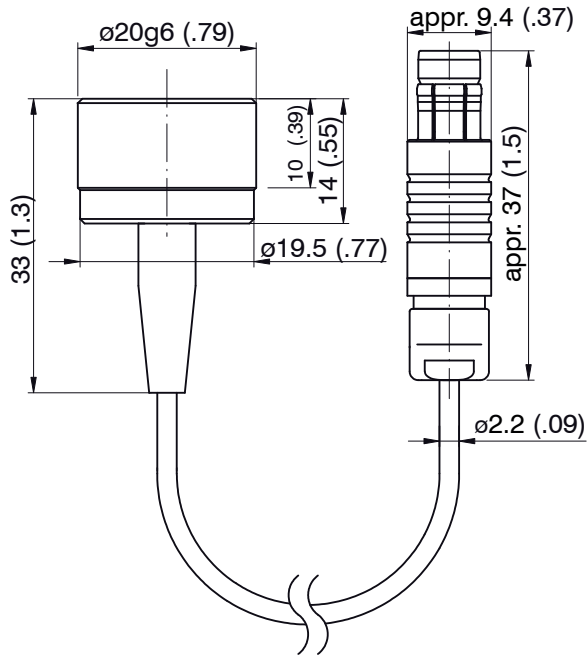

Dimensions in mm (inches), not to scale

Flat sensors

CSH02FL-CRmx,
CSH05FL-CRmx

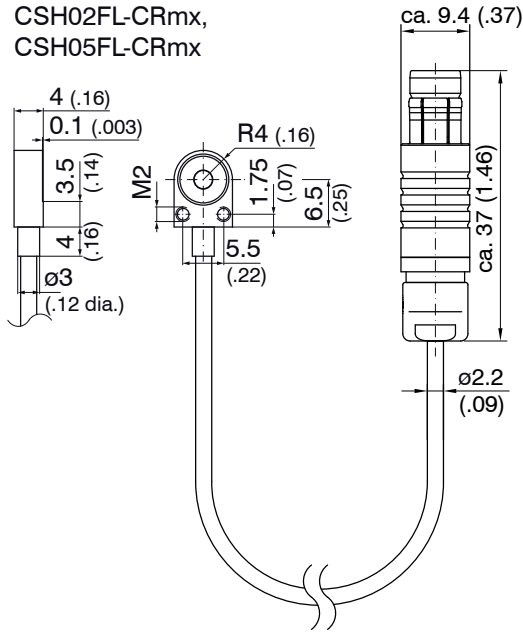

CSH1FL-CRmx,
CSH1.2FL-CRmx

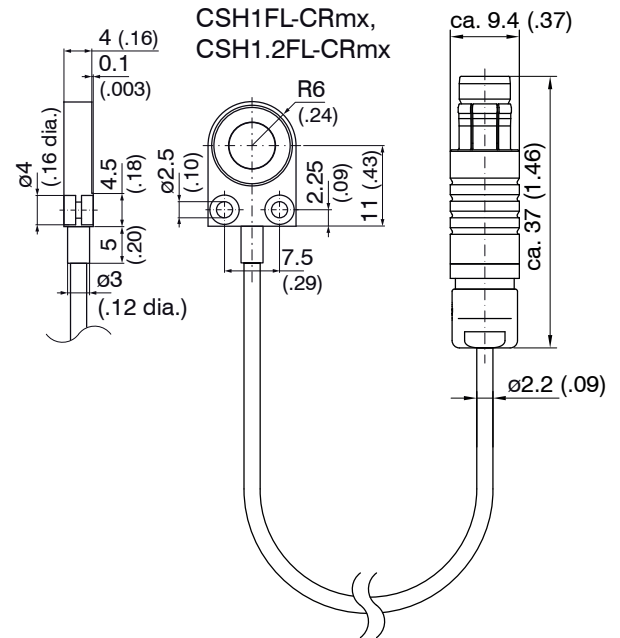

Dimensions in mm (inches), not to scale

CSH2FL-CRmx

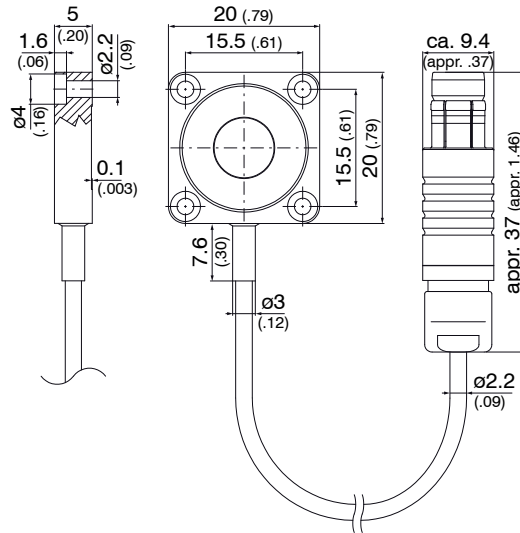

CSH3FL-CRmx

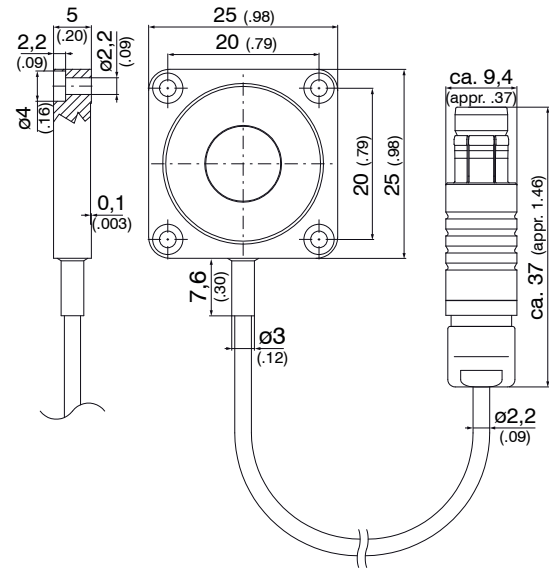

Dimensions in mm (inches), not to scale

4.3 Sensor Cable

The sensor is connected to the controller by the sensor cable. The connection is made by simple plugging. The connector locks automatically. The tight fit can be checked by pulling the connector housing (cable bushing). The lock can be released and the connector can be opened by pulling the knurled housing sleeve of the cable bushing.

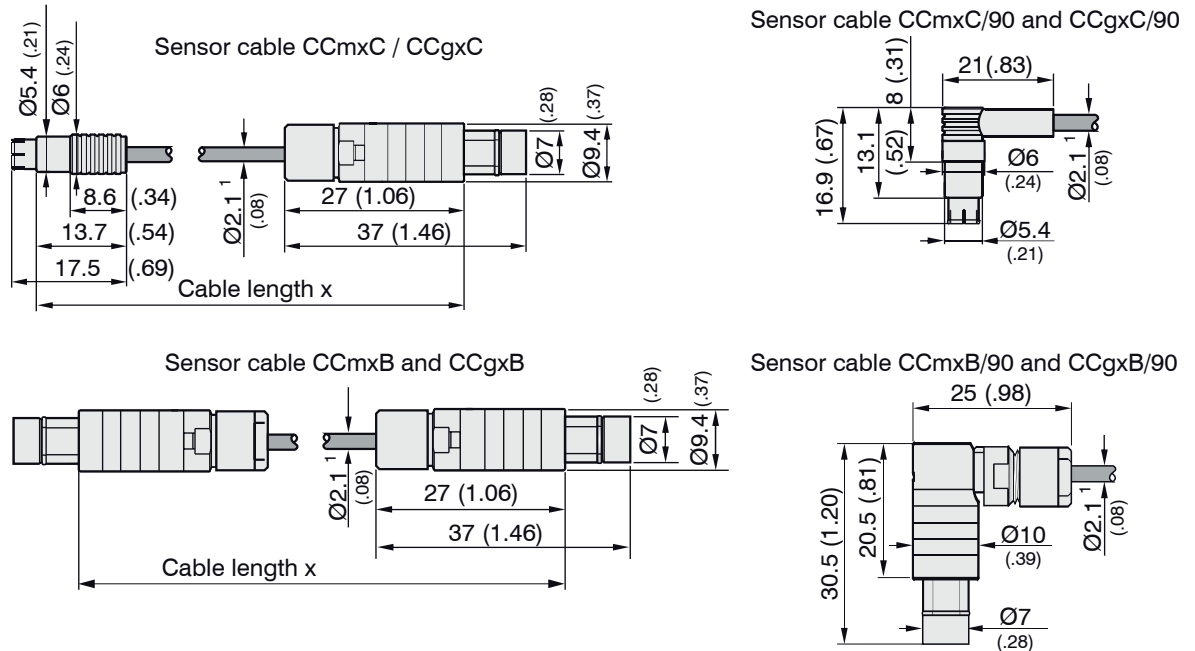

Fig. 6 Dimensional drawings sensor cables

Dimensions in mm (inches), not to scale

Features of the sensor cable, see Chap. 2.2.2.

1) Sensor cable CCgxC/ CCgxB/ CCgxC/90 and CCgxB/90: $\text{Ø}3.1 \pm 0.10$ ($.12 \pm 0.004$ dia.)

4.4 Controller

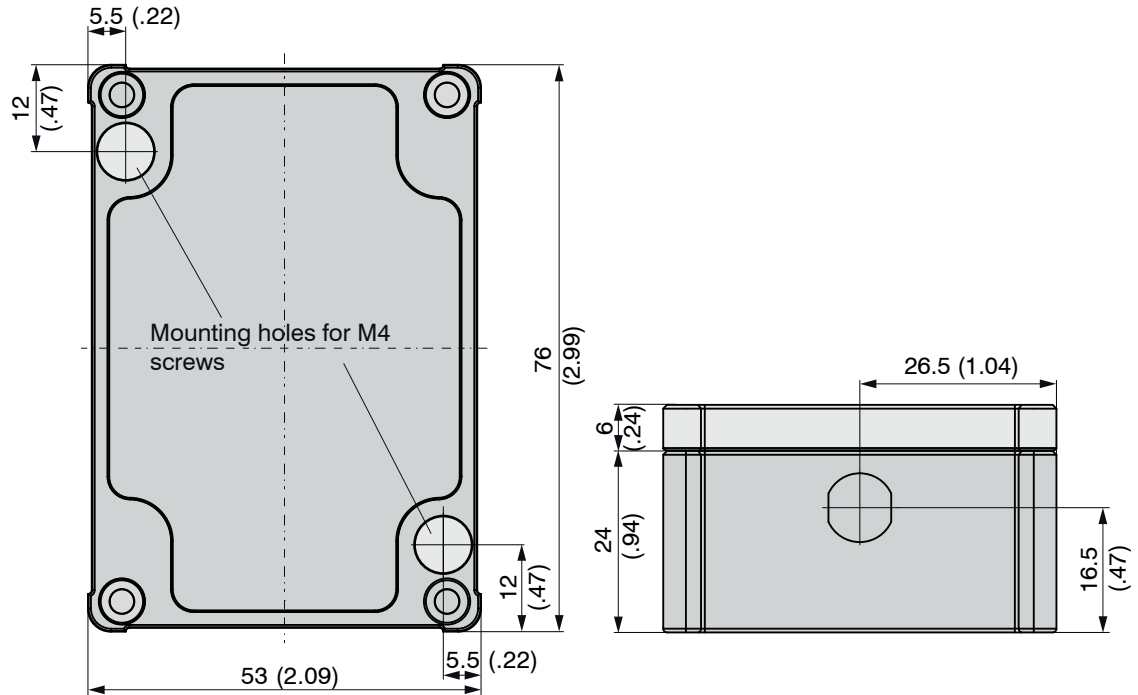

Fig. 7 Dimensional drawing controller

Dimensions in mm (inches), not to scale

4.5 Ground Connection, Earthing

- ➡ Make sure you have a sufficient grounding of the measuring object, for example connect it with the sensor or the supply ground.

4.6 Power Supply, Display/Output Device DT6112

The power supply and signal output occur via the 5-pin connector on the front side of the controller.

Pin	Color SCAC3/5	Signal	Description
1	white	+24 V	+24 V power supply
2	gray	GND	Supply ground
3	yellow	-	not used
4	green	AGND	Analog ground (for signal output)
5	brown	U-out	Signal output (load, min 10 kOhm)
Shield			Cable shield, housing

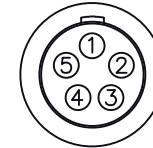

View on solder pin side, 5-pin. female cable connector



Fig. 8 Connection Power supply

SCAC3/5 is a 3 m long, pre-assembled power supply and output cable.



Fig. 9 SCAC3/5 power supply and output cable

4.7 Sensor Connection

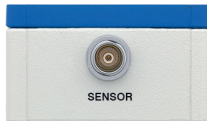

Fig. 10 Connection sensor cable

5. Operation

➡ Connect the display/output devices through the signal output socket, see Chap. 4.6, before connecting the device to the power supply and switching on the power supply.

The measuring system is delivered calibrated. Calibration by the user is not necessary.

i Allow the measuring system to warm up for about 10 minutes before the first measurement.

NOTICE

The power supply may not exceed or continuously fall below the specified limits.

> Damage to or destruction of the sensor and/or controller

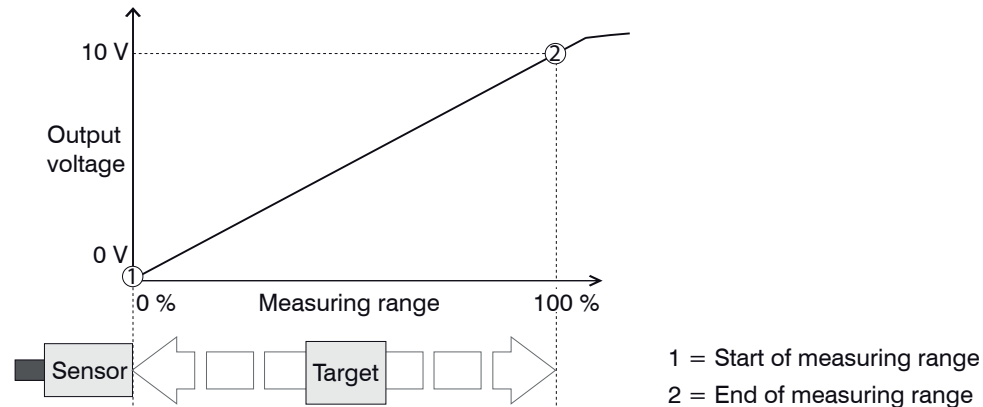

Fig. 11 Signal characteristic in the measuring range

CAUTION

Disconnect the power supply before touching the sensor surface.

> Static discharge

> Danger of injury

6. Maintenance

Make sure that the sensor surface is always clean.

➡ Switch off the power supply before cleaning.

➡ Clean with a clamp cloth; then rub the sensor surface dry.



Disconnect the power supply before touching the sensor surface.

> Static discharge

> Danger of injury

In the event of a defect on the controller, the sensor or the sensor cable please send us the effected parts for repair or exchange. In the case of faults the cause of which is not clearly identifiable, send the whole measuring system back to

MICRO-EPSILON MESSTECHNIK
GmbH & Co. KG
Königbacher Str. 15
94496 Ortenburg / Germany

Tel. +49 (0) 8542 / 168-0
Fax +49 (0) 8542 / 168-90
info@micro-epsilon.de
www.micro-epsilon.com

Sensors of the same type can be replaced without calibrating the controller.

7. Liability for Material Defects

All components of the device have been checked and tested for functionality at the factory. However, if defects occur despite our careful quality control, MICRO-EPSILON or your dealer must be notified immediately.

The liability for material defects is 12 months from delivery. Within this period, defective parts, except for wearing parts, will be repaired or replaced free of charge, if the device is returned to MICRO-EPSILON with shipping costs prepaid. Any damage that is caused by improper handling, the use of force or by repairs or modifications by third parties is not covered by the liability for material defects. Repairs are carried out exclusively by MICRO-EPSILON.

Further claims can not be made. Claims arising from the purchase contract remain unaffected. In particular, MICRO-EPSILON shall not be liable for any consequential, special, indirect or incidental damage. In the interest of further development, MICRO-EPSILON reserves the right to make design changes without notification. For translations into other languages, the German version shall prevail.

8. Decommissioning, Disposal



➡ Remove the power supply cable and all output cables from the controller.

Incorrect disposal may cause harm to the environment.

➡ Dispose of the device, its components and accessories, as well as the packaging materials in compliance with the applicable country-specific waste treatment and disposal regulations of the region of use.

Appendix

A 1 Optional Accessories

PS2020	 A blue DIN rail power supply unit with a perforated top and a DIN rail connector on the side.	<p>Power supply for DIN rail mounting Input 100 - 240 VAC Output 24 VDC / 2.5 A; L/W/H 120 x 120 x 40 mm Built-in type; mounting on symmetrical DIN-rail 35 mm x 7.5 mm, DIN 50022</p>
PS2401/100-240/24V/1A	 A black wall power supply with a two-prong AC plug, a power cord, and two interchangeable output connectors.	<p>Wall power supply; universal power supply open ends; changeable inserts; internationally usable</p>
IF1032/ETH	 A blue and silver interface module with a DIN rail connector, an Ethernet port, and a terminal block.	<p>Interface module Ethernet/EtherCAT - at DT6112: Analog output to Ethernet/ EtherCAT (only 14-bit resolution)</p>

SWH.OS.650.CTMSV

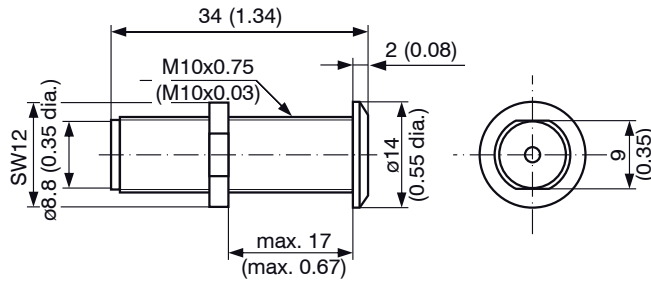

Leak rate $< 1 \cdot 10^{-7}$ mbar \cdot l / s

Vacuum feed through,
 Max. leak rate 1×10^{-7} mbar \cdot l s⁻¹
 Compatible with connector type B

A 2 Tilt Angle Influence on the Capacitive Sensor

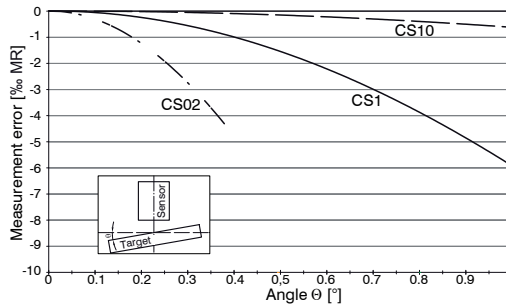

Fig. 12 Example of measuring range deviation in the case of a sensor distance of 10 % of the measuring range

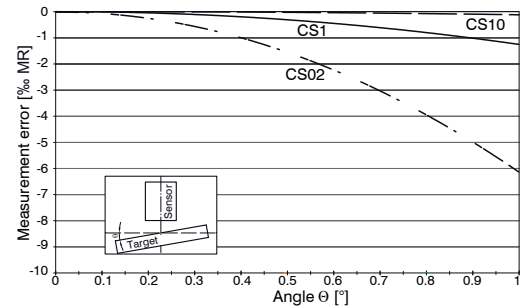

Fig. 13 Example of measuring range deviation in the case of a sensor distance of 50 % of the measuring range

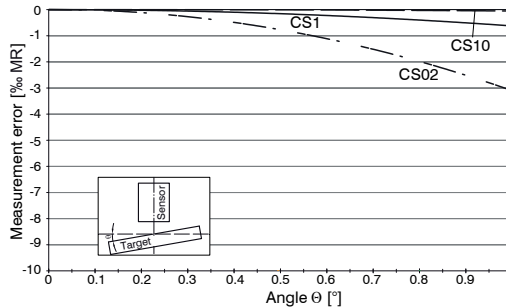

Fig. 14 Example of measuring range deviation in the case of a sensor distance of 100 % of the measuring range

i Figures give an influence example shown on the sensors CS02/CS1 and CS10 in the case of different sensor distances to the target. As this results from internal simulations and calculations, please request for detailed information.

A 3 Measurement on Narrow Targets

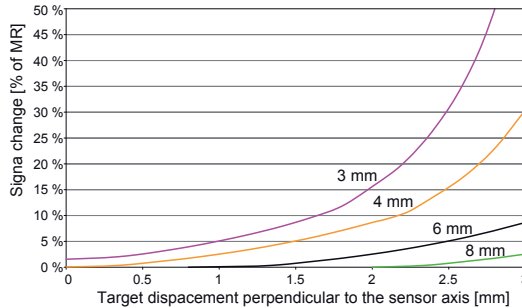

Fig. 15 Example of measuring range deviation in the case of a sensor distance of 10 % of the measuring range

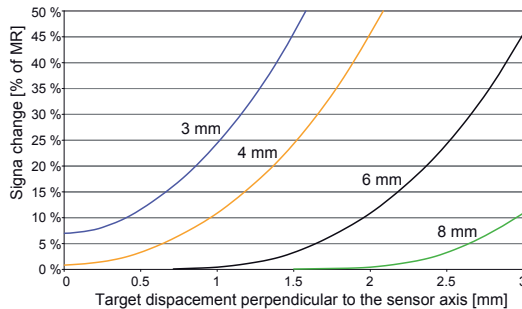

Fig. 17 Example of measuring range deviation in the case of a sensor distance of 100 % of the measuring range

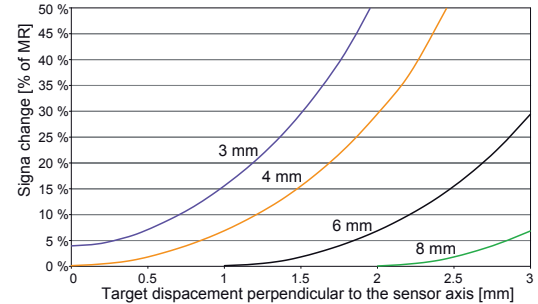

Fig. 16 Example of measuring range deviation in the case of a sensor distance of 50 % of the measuring range

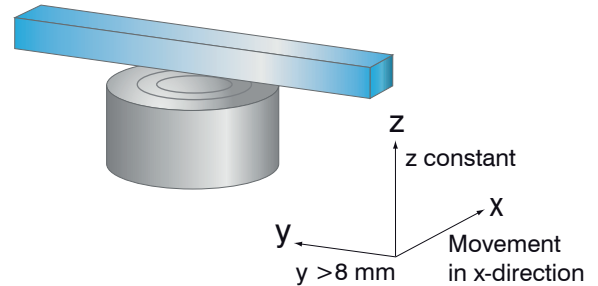

Fig. 18 Signal change in the case of displacement of thin targets in the opposite direction to the measurement direction

i Figures give an influence example shown on the sensors CS05 in the case of different sensor distances to the target as well as target widths. As this results from internal simulations and calculations, please request for detailed information.

A 4 Measurements on Balls and Shafts

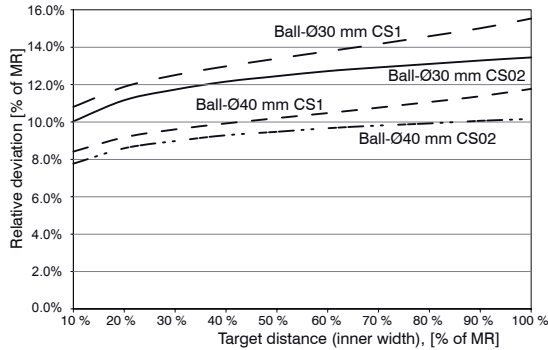

Fig. 19 Measuring value deviation in the case of measurement on ball-shaped targets

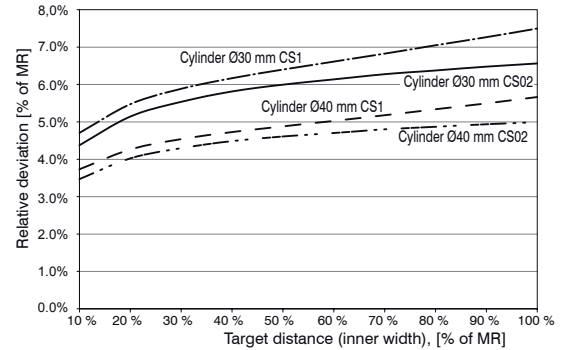

Fig. 20 Measuring value deviation in the case of measurement on cylindrical targets

i Figures give an influence example shown on the sensors CS02 and CS1 in the case of different sensor distances to the target as well as target diameters. As this results from internal simulations and calculations, please request for detailed information.



MICRO-EPSILON MESSTECHNIK GmbH & Co. KG
Königbacher Str. 15 · 94496 Ortenburg / Germany
Tel. +49 (0) 8542 / 168-0 · Fax +49 (0) 8542 / 168-90
info@micro-epsilon.de · www.micro-epsilon.com

X9751365-A031078HDR

© MICRO-EPSILON MESSTECHNIK

