



More Precision

thermoMETER // Non-contact infrared temperature sensors





thermoMETER CTM3

Miniaturized temperature sensor with $2.3\ \mu\text{m}$ measuring wavelength for measurements from $50\ ^\circ\text{C}$

- Measuring range from $50\ ^\circ\text{C}$ to $1800\ ^\circ\text{C}$
- Up to $85\ ^\circ\text{C}$ ambient temperature without cooling
- For metal and composite processing
- Extended compensation for measuring errors using short measuring wavelength (e.g. with emissivity changes or misadjustment)
- High compatibility with electromagnetic fields e.g. with induction welding
- Compact sensor for installation in confined spaces
- Selectable and scalable analog output, optional digital interfaces

Optical specifications thermoMETER CTM3

□ = smallest spot size / focal point (mm)

Standard Focus

3SF22	22:1	6.5	14.4	22.3	30.2	38.1	46	55.1	65.4	75.7	
3SF33	33:1	6.5	11.8	17	22.3	27.5	32.8	38	43.3	48.5	
3SF75H1/H2/H3	75:1	6.5	8.4	10.2	12.1	13.9	15.8	17.6	19.5	21.3	
distance in mm		0	200	400	600	800	1000	1200	1400	1600	

Close Focus (integrated CF lens)

3CF22	22:1	6.5	6	5.4	5	9.2	14.4	19.6	24.9	30.1	35.3
3CF33	33:1	6.5	5.4	4.2	3.4	7	11.5	16	20.5	25	29.5
distance in mm		0	40	80	110	150	200	250	300	350	400

Close Focus (integrated CF lens)

3CF75H1/H2/H3	75:1	6.5	3.8	1.5	4.4	8	11.7	15.3	19	22.6	
distance in mm		0	60	110	150	200	250	300	350	400	

Model	CTM-3SF22-C3	CTM-3SF33-C3	CTM-3SF75H1-C3	CTM-3SF75H2-C3	CTM-3SF75H3-C3
Optical resolution ¹⁾	22:1	33:1	75:1	75:1	75:1
Temperature range ^{2), 3)}	50 to 400 °C	100 to 600 °C	150 to 1000 °C	200 to 1500 °C	250 to 1800 °C
Spectral range	2.3 μm				
System accuracy ^{4), 5)}	±(0.3 % of reading + 2 °C)				
Repeatability ⁴⁾	±(0.1 % of reading + 1 °C)				
Temperature resolution (digital)	0.1 °C				
Response time ⁶⁾	1 ms (90 %)				
Emissivity/gain ²⁾	0.100 to 1.100				
Transmissivity ²⁾	0.100 to 1.100				
Signal processing ²⁾	peak hold, valley hold, average; extended hold function with threshold and hysteresis				
Certificate of calibration	optional				
Outputs/analog	channel 1	0/4 to 20 mA, 0 to 5/10 V, thermocouple J, K			
Outputs/analog	optional	relays: 2 x 60 VDC/42 VAC _{eff} ; 0.4 A; electrically isolated			
Alarm output		open collector (24 V / 50 A)			
Outputs/digital	optional	USB, RS232, RS485, Modbus RTU, Profibus DP, Ethernet			
Output impedances	current output	mA max. 500 Ω (with 8 to 36 VDC)			
	voltage output	min. 100 kΩ load impedance, thermocouple 20 Ω			
Inputs		programmable functional inputs for external emissivity adjustment, ambient temperature compensation, trigger (reset of hold functions)			
Cable length		3 m			
Power supply		8 to 36 VDC; max. 100 mA			
Protection class		IP65 (NEMA-4)			
Ambient temperature		sensor: -40 °C to 85 °C; controller: 0 °C to 85 °C			
Storage temperature		sensor: -40 °C to 125 °C; controller: -40 °C to 85 °C			
Relative humidity		10 to 95 %, non-condensing			
Vibration	sensor	IEC 68-2-6: 3 G, 11 to 200 Hz, any axis			
Shock	sensor	IEC 68-2-27: 50 G, 11 ms, any axis			
Weight		sensor: 40 g; controller: 420 g			

¹⁾ 90 % energy

²⁾ adjustable via programming keys or software

³⁾ target temperature > sensor temperature + 25 °C

⁴⁾ ambient temperature: 23 ± 5 °C

⁵⁾ ε=1, response time 1 s

⁶⁾ with dynamic adaption at low signal levels

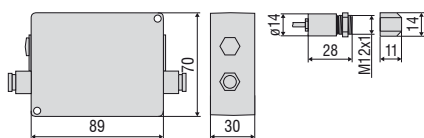

Product identification

CTM-	3	SF22-	C3
		Cable length [3 m]	
		Focus [SF22 / SF33 / SF75 / CF22 / CF33 / CF75]	
		Spectral range [2.3 μm]	
thermoMETER CTM			

Accessories page 40 - 43

- Protective window
- Rail mount adapter for controller
- Mounting bracket / mounting bolt
- Massive housing
- Air purge collar
- Protective tube
- Right angle mirror
- Laser sighting aid
- Digital-interface kits
- Certificate of calibration

CT / CTfast / CTM1/M2/M3

controller

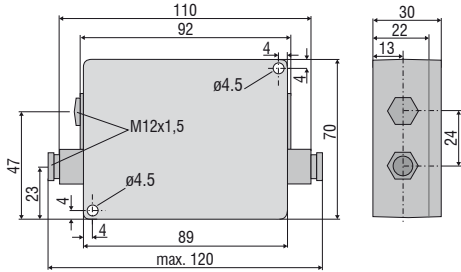

ancillary CF lens (optional)



sensor

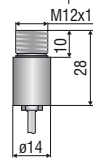

CThot / CTP-3 / CTP-7

controller

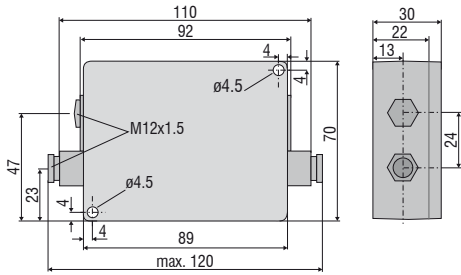

sensor with protective housing

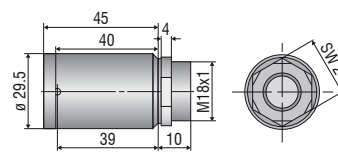

CTM3-XL

controller

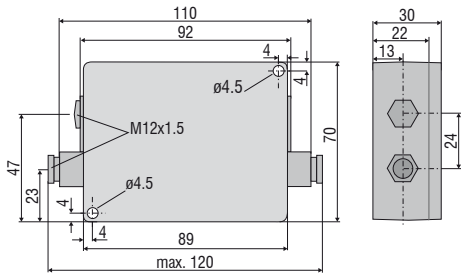

sensor

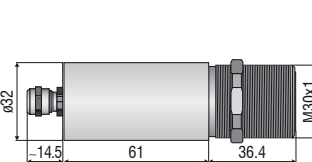

CTex

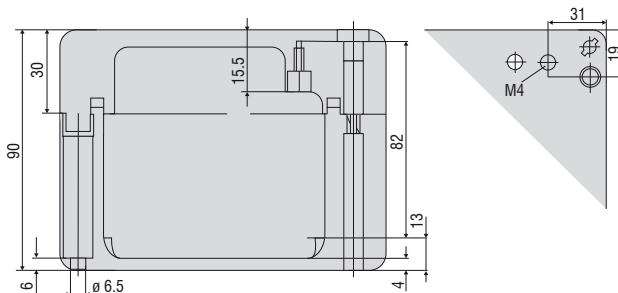
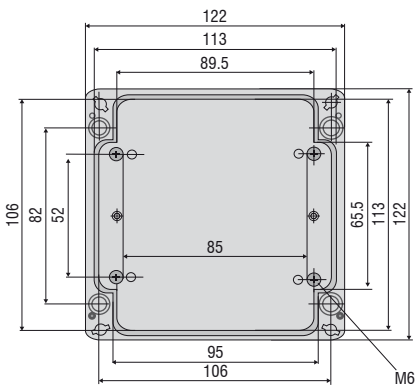

Mechanical accessories		
Art. No.	Model	
2970203	TM-FB-CT	Mounting bracket, fixed
2970325	TM-FB2-CT	Mounting bracket, adjustable in one axis, for simultaneous assembly of CT sensor and laser sighting aid
2970336	TM-FBMH-CT	Mounting bracket, adjustable in one axis, for massive housing
2970204	TM-AB-CT	Mounting bracket, adjustable in 2 axes
2970205	TM-MB-CT	Mounting bolts with M12x1 thread
2970206	TM-MG-CT	Mounting fork, adjustable in 2 axes, with M12x1 fastening
2970207	TM-AP-CT	Air purge collar for sensors from 10:1 lens
2970335	TM-APS-CT	Air purge collar for sensors from 10:1 lens made from stainless steel
2970208	TM-AP2-CT	Air purge collar for sensor with 2:1 lens
2970209	TM-APL-CT	Air purge collar, laminar
2970210	TM-APLCF-CT	Air purge collar, laminar with integrated ancillary CF lens
2970357	TM-APLCFH-CT	Air purge collar, laminar with integrated ancillary CF lens for M1/M2/M3/M5 sensors
2970386	TM-APMH-CT	Air purge collar made from stainless steel for massive housing
2970463	TM-TAS-CT	Pivoted joint for CT sensors
2970211	TM-RAM-CT	Right angle mirror for measurements 90 °C to the sensor axis
2970212	TM-RAIL-CT	Rail mount adapter for CT controller
2970213	TM-COV-CT	Closed cover for controller
2970214	TM-MHS-CT	Massive housing made from stainless steel
2970215	TM-MHSFC-CT	Massive housing made from stainless steel with integrated ancillary CF lens
2970358	TM-MHSFCFH-CT	Massive housing made from stainless steel with integrated ancillary CF lens for M1/M2/M3/M5 sensors
2970216	TM-MHA-CT	Massive housing made from anodized aluminum
2970217	TM-MHACF-CT	Massive housing made from stainless steel with integrated ancillary CF lens
2970359	TM-MHACFH-CT	Massive housing made from anodized aluminum with integrated ancillary CF lens for M1/M2/M3/M5 sensors
2970326	TM-PA-CT	Pipe adapter for the mounting of reflection protection tubes
2970327	TM-ST20-CT	Reflection protection tube, length 20 mm
2970328	TM-ST40-CT	Reflection protection tube, length 40 mm
2970329	TM-ST88-CT	Reflection protection tube, length 88 mm
2970221	TM-LST-CT	Laser sighting aid for CT sensors incl. batteries (2xAlkaline AA)
2970300	TM-LSTOEM-CT	OEM laser sighting aid, 635 nm, 3.5 m cable, for connection to CT controller
2970300.008	TM-LSTOEM-CT(008)	OEM laser sighting aid, 635 nm, 8 m cable, for connection to CT controller

Optical accessories		
Art. No.	Model	
2970201	TM-CF-CT	Ancillary CF lens (only for SF models)
2970202	TM-PW-CT	Protective window (only for SF models)
2970297	TM-CFAG-CT	Ancillary lens with external thread
2970330	TM-CFH-CT	Ancillary lens for M1/M2/M3/M5 sensors
2970331	TM-CFHAG-CT	Ancillary lens with external thread for M1/M2/M3/M5 sensors
2970299	TM-PWAG-CT	Protective window with external thread
2970332	TM-PWH-CT	Protective window for M1/M2/M3/M5 sensors
2970333	TM-PWHAG-CT	Protective window with external thread for M1/M2/M3/M5 sensors

Interfaces		
Art. No.	Model	
2970729	TM-USBK-CT	USB-Interface-board, cable with Micro-USB plug and adapter for USB-C and USB-A, CompactConnect software (as download), Quick reference, second cable gland for controller
2970224	TM-RS232K-CT	RS232 interface: RS232 interface, computer cable, CompactConnect software, second cable gland for controller
2970338	TM-RS485USBK-CTL	RS485-USB-adapter, incl. PC cable, CompactConnect software and CTmulti, second cable gland for use with interface board TM-RS485B-CT
2970226	TM-RS485B-CT	RS485 interface board incl. second cable gland
2970227	TM-CANK-CT	CAN-Bus interface for thermoMETER CT/ protocol: CANopen presets: module address 20 (14H), 250 kBaud, 0-60 °C
2970228	TM-PFBDPK-CT	Profibus-DPv1 interface for thermoMETER CT with plug-in connection
2970229	TM-ETHNK-CT	Ethernet-Kit: interface board, external Ethernet adapter, CompactConnect software, second cable gland
2970230	TM-RI-CT	Relay interface: two electrically isolated relays, 60 VDC/ 42 VAC _{eff} , 0.4 A

Calibration		
Art. No.	Model	
2970231	TM-CERT-CT	Certificate of calibration
2970310	TM-HTCERT-CT	Certificate of calibration for CTM sensors

CTM3-XL		
Art. No.	Model	
2970352	TM-FBXL-CT	Mounting bracket, adjustable in one axis
2970353	TM-ABXL-CT	Mounting bracket, adjustable in 2 axes
2970354	TM-APXL-CT	Air purge collar, stainless steel
2970361	TM-XLCERT-CT	Certificate of calibration



TM-FB-CT Mounting bracket, adjustable in one axis

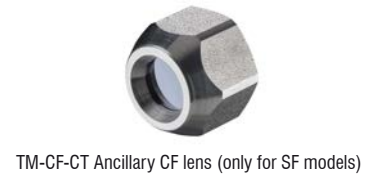

TM-CF-CT Ancillary CF lens (only for SF models)

TM-CFAG-CT Ancillary CF lens with external thread
TM-PWAG-CT Protective window with external thread

TM-AB-CT Mounting bracket, adjustable in two axes

TM-MB-CT mounting bolt with M12x1 thread
adjustable in one axisTM-APL-CT Air purge collar, laminar and
TM-MG-CT Mounting fork

TM-MG-CT Mounting fork with M12x1 thread, adjustable in two axes

TM-APLCF-CT
Ancillary CF lens/protective window - integrable variant
for laminar air purge collar

TM-RAIL-CT rail mount adapter for controller

TM-KF40GE-CT KF40 Flange with Ge window
TM-KF40B270-CT KF40 Flange for CTM-1,-2,-3
with B270 windowTM-APMH-CT
Air purge collar made from stainless steel
for massive housing

TM-PA-CT Pipe adapter for reflection protection tube



TM-ST40-CT Reflection protection tube





TM-LST-CT Laser sighting aid, battery-operated
(2x Alkaline AA), for alignment of CT sensors
(dimensions identical to CT sensor)



TM-FB2-CT
Mounting bracket for sensor and laser sighting aid



TM-RAM-CT
Right angle mirror



TM-MHS-CT Massive housing, stainless steel
TM-MHA-CT Massive housing, aluminum

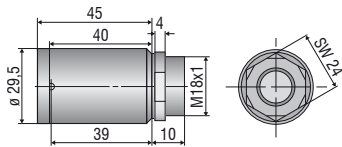

TM-TAS-CT Pivoted joint for CT sensors



Dirt and deposit on the lens like smoke, steam and high air humidity (condensation) are avoided or reduced by using an air purge collar.

TM-AP-CT
Standard air purge collar for 10:1 / 15:1 / 22:1 lenses
TM-APS-CT
Air purge collar, stainless steel



TM-AP2-CT
Standard air purge collar for 2:1 lens

Infrared thermal imagers from Micro-Epsilon



thermoIMAGER TIM Compact thermal imaging cameras for industrial temperature monitoring

- Temperature range from -20 °C to 2450 °C
- Ideal for OEM
- Real-time thermography using license-free software
- Protective housing for harsh environments
- Special variants for the glass, metal and plastics industries