









More Precision

scanCONTROL // 2D/3D Laser profile sensors



Powerful 2D/3D laser scanners

scanCONTROL 30x2

-  Precise profile measurements for industrial measurement tasks
-  Resolution x-axis: 1,024 points
-  Profile frequency up to 10,000 Hz
-  For small and large measurement areas
-  Also available with patented Blue Laser Technology
-  Compatible with **COGNEX® VisionPro**



Precise 2D/3D profile measurements

The new LLT30x2 laser profile scanners provide calibrated profile data with up to 7.9 million points per second. They allow profile frequencies up to 10 kHz and resolutions up to 1,024 points. Thanks to their high accuracy and versatility, the scanners are particularly suitable for static and dynamic applications as well as robotic applications. They measure and evaluate, e. g., angles, steps, gaps, distances, and circles.

Available as PROFILE and SMART versions

The scanCONTROL 30x2 series is available as PROFILE and SMART versions. PROFILE scanners provide calibrated profile data that can be further processed on a PC using software provided by the customer. With the 3DInspect software, the scanCONTROL sensors can also be used for 3D evaluations. SMART series scanners work independently and provide selected measurement values. The scanCONTROL 30x2 series supports all SMART functions and programs that are set in the scanCONTROL Configuration Tools software and directly stored in the internal controller.

Article designation

LLT	30	x2	-25	/SI	
Options - see below					
Measuring range					
25 mm					
50 mm					
100 mm					
200 mm					
430 mm					
600 mm					
Class					
02 = PROFILE					
12 = SMART					
Series					
LLT30xx					

Laser options*

	/SI	Hardware switch-off of the laser line
	/3R	Increased laser power (class 3R) e.g., for dark surfaces
	/BL	Blue laser line (405 nm) for (semi-) transparent, red-hot glowing and organic materials (Measuring ranges 25 - 100 mm)

Cable outlet options*

	/RT	Cable outlet on the rear side ("Rear Tail") for space-saving installation, cable length 0.3 m. Sockets at cable end (Measuring ranges 25 - 200 mm)
	/PT	Cable directly out of the sensor ("Pigtail") Available lengths: 0.3 / 0.6 / 1.00 m

*Options can be combined

Accessories from page 39



The easy way of machine integration

The design of the LLT30x2 series is compact and lightweight. The controller is integrated in the sensor itself, which simplifies mechanical integration. The measurement data can be output directly.

NEW

Large measurement area up to 600 x 600 mm

The scanCONTROL 30x2 laser scanners are now also available with a large measuring field up to 600 x 600 mm. This allows large measuring objects to be detected with high accuracy.



Application examples

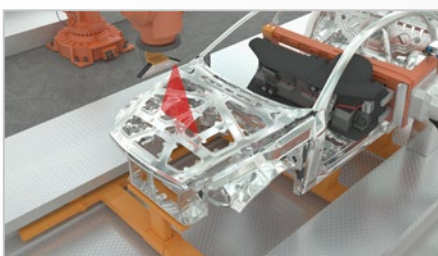

Assembly monitoring of car body shell construction



Detection of the road surface profile



Geometry inspection in metals processing

Powerful 2D/3D laser scanners

scanCONTROL 30x2

Model		LLT30x2-25	LLT30x2-50	LLT30x2-100	LLT30x2-200
Measuring range (z-axis)	Start of measuring range	77.5 mm	105 mm	200 mm	200 mm
	Mid of measuring range	85 mm	125 mm	270 mm	310 mm
	End of measuring range	92.5 mm	145 mm	340 mm	420 mm
	Height of measuring range	15 mm	40 mm	140 mm	220 mm
Extended measuring range (z-axis)	Start of measuring range	-	-	190 mm	160 mm
	End of measuring range	-	-	360 mm	460 mm
Line linearity (z-axis) ^[1] ^[2]		2 μ m	4 μ m	10 μ m	30 μ m
		± 0.013 %	± 0.01 %	± 0.007 %	± 0.014 %
Measuring range (x-axis)	Start of measuring range	23 mm	43.3 mm	75.6 mm	130 mm
	Mid of measuring range	25 mm	50 mm	100 mm	200 mm
	End of measuring range	26.8 mm	56.5 mm	124.4 mm	270 mm
Extended measuring range (x-axis)	Start of measuring range	-	-	72.1 mm	100 mm
	End of measuring range	-	-	131.1 mm	290 mm
Resolution (x-axis)		1,024 points/profile			
Profile frequency		up to 10,000 Hz			
Interfaces	Ethernet GigE Vision	Output of measurement values Sensor control Profile data transmission			
	Digital inputs	Mode switching Encoder (counter) Trigger			
	RS422 (half-duplex) ^[3]	Output of measurement values Sensor control Trigger Synchronization			
Output of measurement values ^[4] ^[5]		Ethernet (UDP / Modbus TCP); RS422 (ASCII / Modbus RTU) Analog; switch signal PROFINET; EtherCAT; EtherNet/IP			
Control and indicator elements		3x color LEDs for laser, data and error			
Light source	Red Laser	≤ 10 mW			≤ 12 mW
		Standard: laser class 2M, semiconductor laser 658 nm			
	≤ 30 mW			≤ 50 mW	
	Option: laser class 3R, semiconductor laser 658 nm				
Blue laser	≤ 10 mW			-	
	Standard: laser class 2M, semiconductor laser 405 nm			-	
Laser switch-off		via software, hardware switch-off with /SI option			
Aperture angle of laser line		23 °	28 °	30 °	45 °
Permissible ambient light (fluorescent light) ^[1]		10,000 lx			
Protection class (DIN EN 60529)		IP67 (when connected)			
Vibration (DIN EN 60068-2-27)		2g / 20 ... 500 Hz			
Shock (DIN EN 60068-2-6)		15g / 6 ms			
Temperature range	Storage	-20 ... +70 °C			
	Operation	0 ... +45 °C			
Weight		415 g (without cable)			
Supply voltage		11 ... 30 VDC, nominal value 24 V, 500 mA, IEEE 802.3af class 2, Power over Ethernet (PoE)			

^[1] Based on the measuring range; measuring object: Micro-Epsilon standard object

^[2] According to a one-time averaging across the measuring field (1,024 points)

^[3] RS422 interface, programmable either as serial interface or as input for triggering/synchronization

^[4] Analog | switching signal: Only in conjunction with 2D/3D output unit

^[5] PROFINET | EtherCAT | EtherNet/IP: Only in conjunction with 2D/3D gateway

Model		LLT30x2-430	LLT30x2-600
Measuring range (z-axis)	Start of measuring range	330 mm	530 mm
	Mid of measuring range	515 mm	770 mm
	End of measuring range	700 mm	1 010 mm
	Height of measuring range	370 mm	480 mm
Extended measuring range (z-axis)	Start of measuring range	330 mm	450 mm
	End of measuring range	720 mm	1 050 mm
Line linearity (z-axis) ^[1] ^[2]		15 μ m	22 μ m
		0.0041 %	0.0045 %
Measuring range (x-axis)	Start of measuring range	324 mm	456 mm
	Mid of measuring range	430 mm	600 mm
	End of measuring range	544 mm	762 mm
Extended measuring range (x-axis)	Start of measuring range	324 mm	408 mm
	End of measuring range	560 mm	788 mm
Resolution (x-axis)		1,024 points/profile	
Profile frequency		up to 10,000 Hz	
Interfaces	Ethernet GigE Vision	Output of measurement values Sensor control Profile data transmission	
	Digital inputs	Mode switching Encoder (counter) Trigger	
	RS422 (half-duplex) ^[3]	Output of measurement values Sensor control Trigger Synchronization	
Output of measurement values ^[4] ^[5]		Ethernet (UDP / Modbus TCP); RS422 (ASCII / Modbus RTU) Analog; switch signal PROFINET; EtherCAT; EtherNet/IP	
Control and indicator elements		3x color LEDs for laser, data and error	
Light source	Red Laser	≤ 26 mW	
		Standard: laser class 2M, semiconductor laser 660 nm	
		≤ 100 mW	
		Option: laser class 3B, semiconductor laser 660 nm	
Laser switch-off		via software, hardware switch-off with /SI option	
Aperture angle of laser line		60 °	
Permissible ambient light	(fluorescent light) ^[1]	5,000 lx	
Protection class (DIN EN 60529)		IP67 (when connected)	
Vibration (DIN EN 60068-2-27)		2g / 20 ... 500 Hz	
Shock (DIN EN 60068-2-6)		15g / 6 ms	
Temperature range	Storage	-20 ... +70 °C	
	Operation	0 ... +45 °C	
Weight		2620 g (without cable)	
Supply voltage		11 ... 30 VDC, nominal value 24 V, 500 mA, IEEE 802.3af class 2, Power over Ethernet (PoE)	

^[1] Based on the measuring range; measuring object: Micro-Epsilon standard object

^[2] According to a one-time averaging across the measuring field (1,024 points)

^[3] RS422 interface, programmable either as serial interface or as input for triggering/synchronization

^[4] Analog | switching signal: Only in conjunction with 2D/3D output unit

^[5] PROFINET | EtherCAT | EtherNet/IP: Only in conjunction with 2D/3D gateway

Dimensions and measuring ranges

scanCONTROL 30xx

LLT30x2-25 / LLT30x0-25

Red Laser Blue Laser

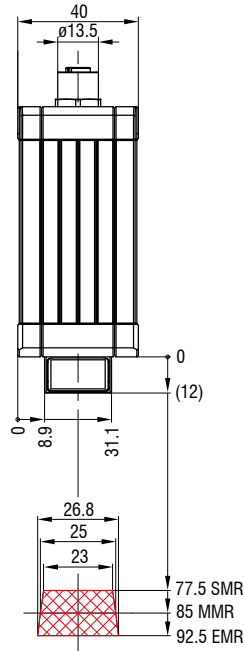
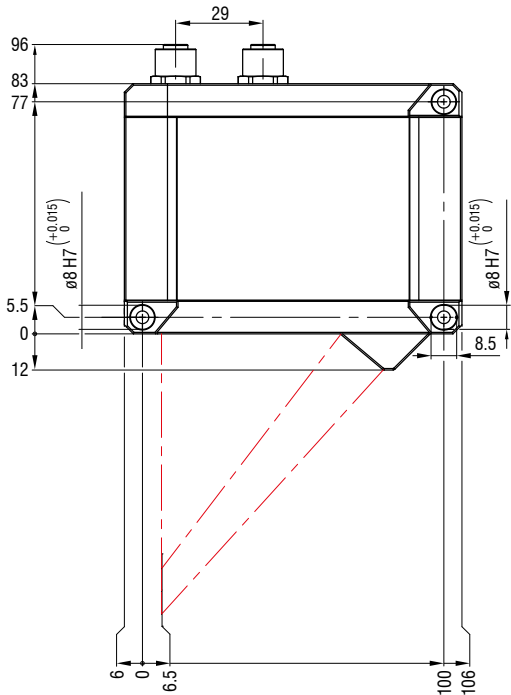

LLT30x2-50 / LLT30x0-50

Red Laser Blue Laser

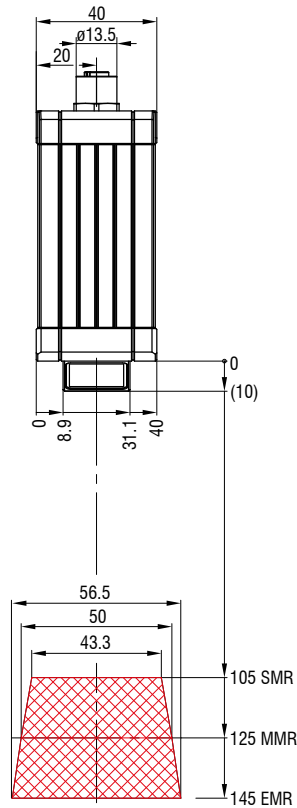
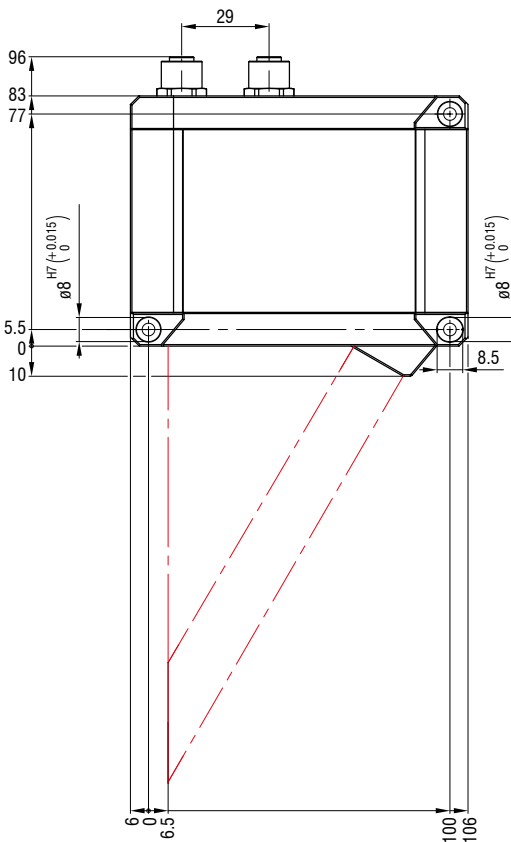

(dimensions in mm, not to scale)

Dimensions and measuring ranges

scanCONTROL 30xx

LLT30x2-100 / LLT30x0-100

Red Laser

Blue Laser

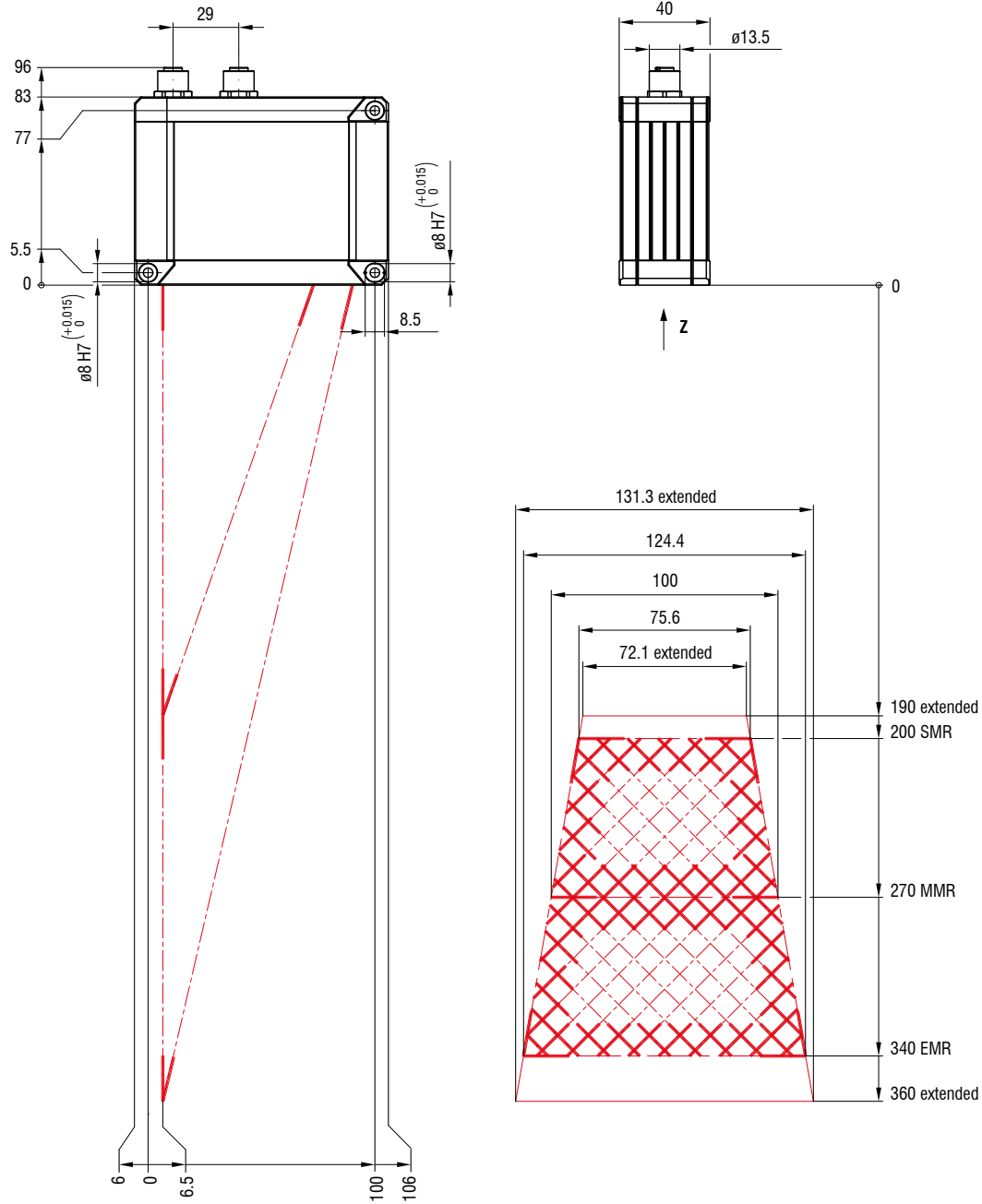

(dimensions in mm, not to scale)

LLT30x2-200 / LLT30x0-200

Red Laser

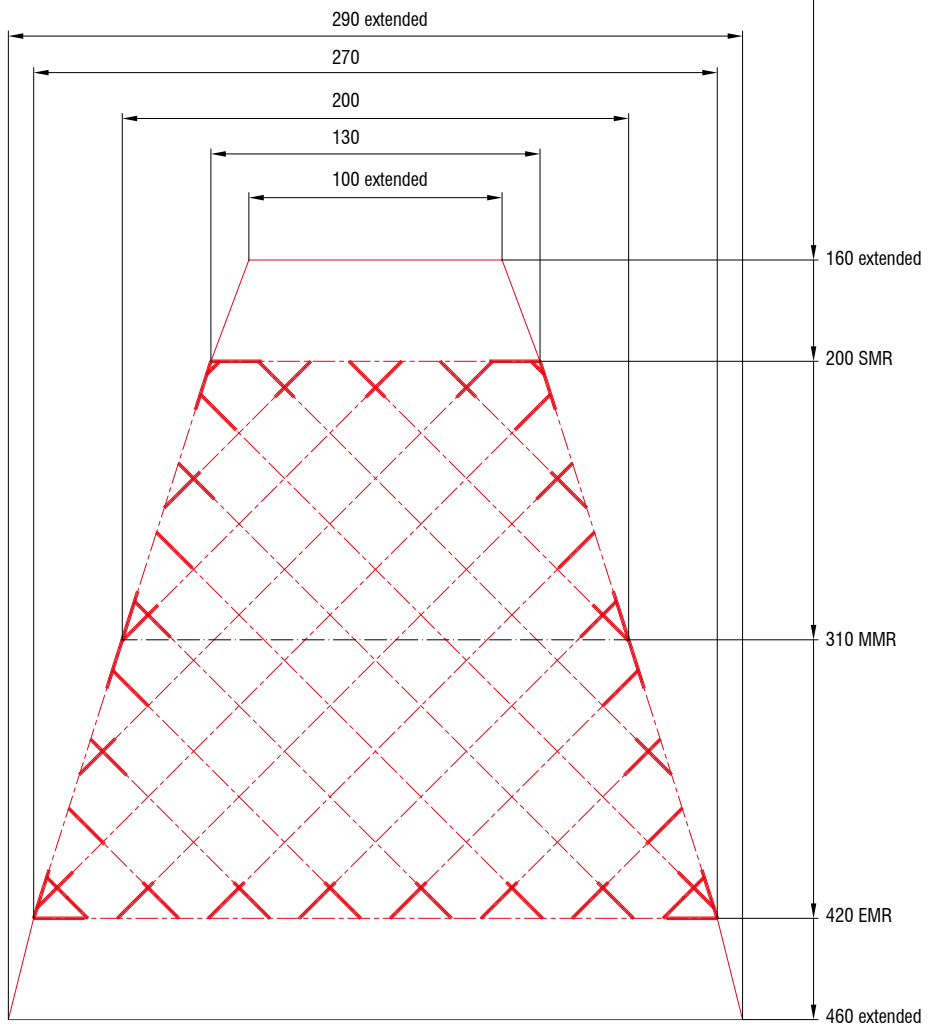
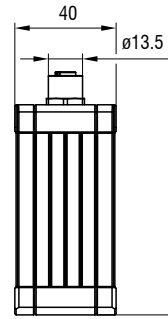
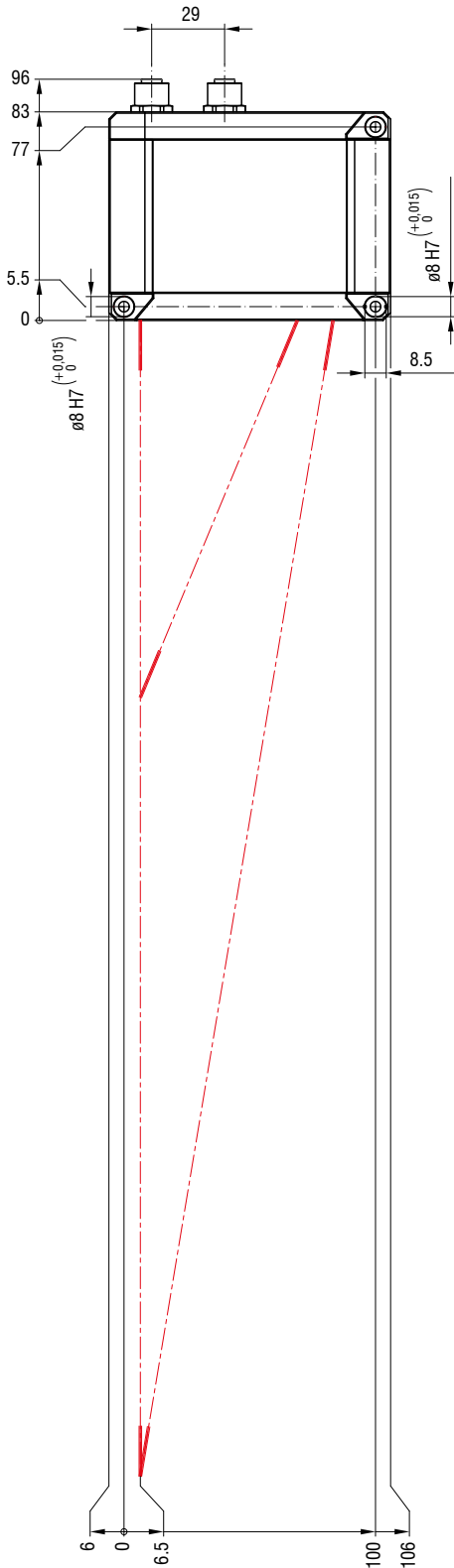

(dimensions in mm, not to scale)

Dimensions and measuring ranges

scanCONTROL 30xx

LLT30x2-430 / LLT30x0-430

Red Laser

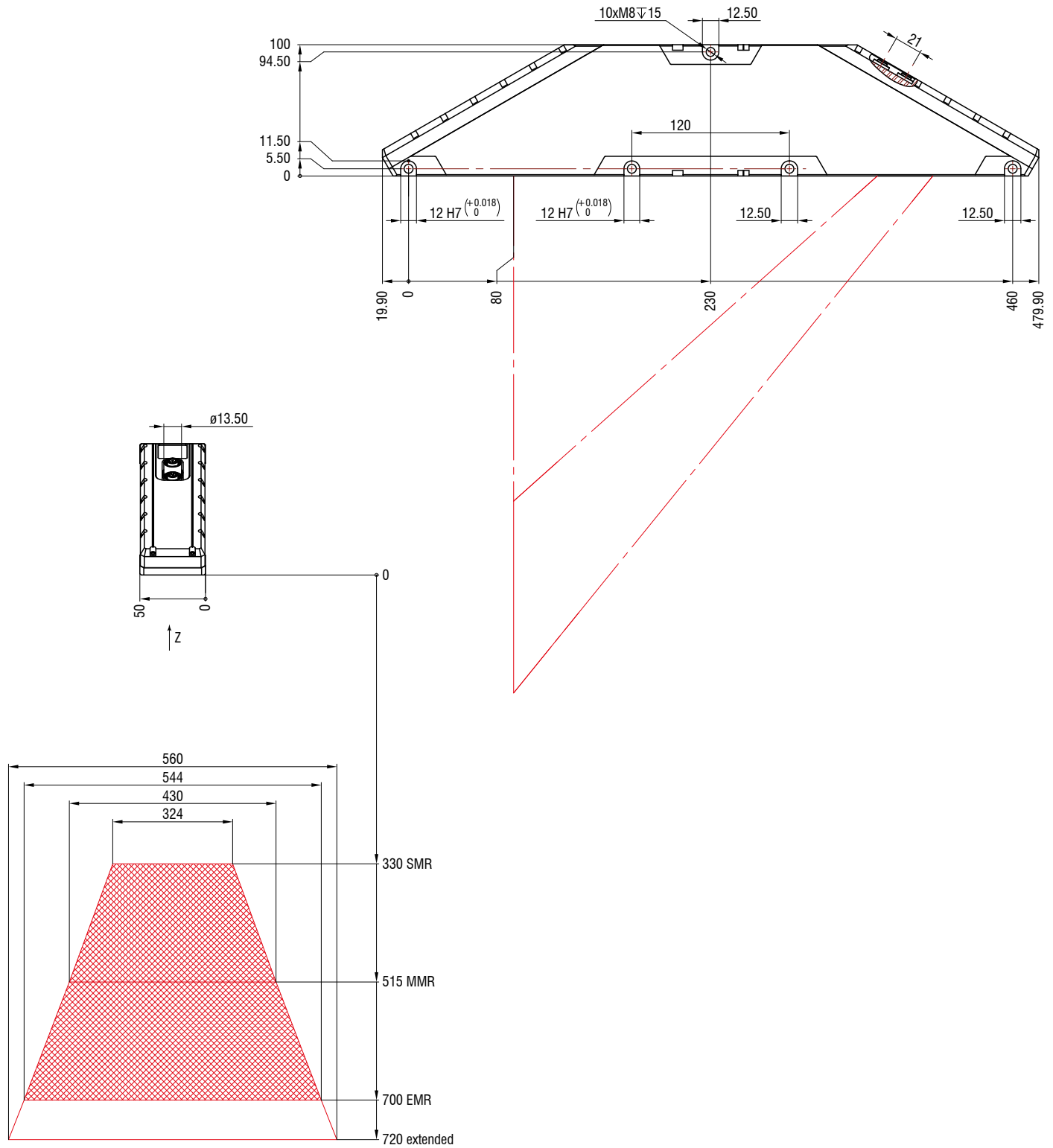

(dimensions in mm, not to scale)



micro-epsilon.com/
scanner/download

Software for scanCONTROL SMART sensors

SMART

scanCONTROL Configuration Tools

Solution of complex 2D measurement tasks

- Can be used with all SMART sensors
- Sensor alignment and adjustment
- 16 measuring programs x 8 evaluations per parameter set
- 15 independent parameter packages can be stored in the sensor
- Data processing
- Logical operations for digital outputs
- Configuration of the measurement value transfer and the outputs



scanCONTROL Result Monitor

Visualization of measurement sequences

- For up to 4 scanCONTROL SMART sensors
- Display of profile and measured value history during operation
- Adjustable layout (different views, e.g. for workers)
- Parallel transmission of the measured values to the control unit is possible and recommended
- Logging and saving of profiles

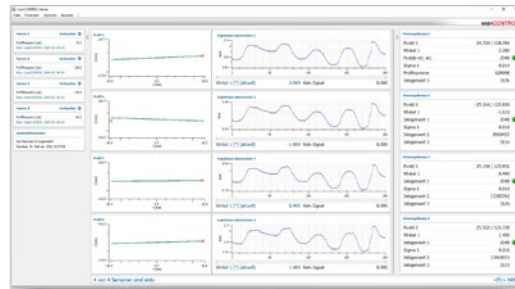

scanCONTROL UDP Tool

Testing the UDP output of measured values

- For all scanCONTROL SMART sensors
- Logging possible up to 1,000 Hz
- Source code available

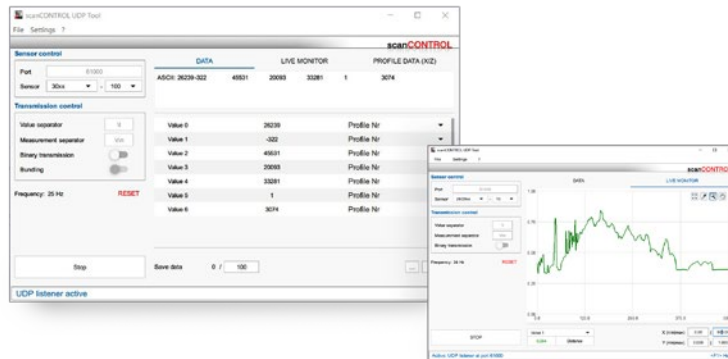

scanCONTROL Modbus Tool

Testing the Modbus communication

- For all scanCONTROL SMART sensors
- Transfer of measured data
- Sensor control via Modbus TCP
(load user modes, laser on/off, change exposure time, ...)

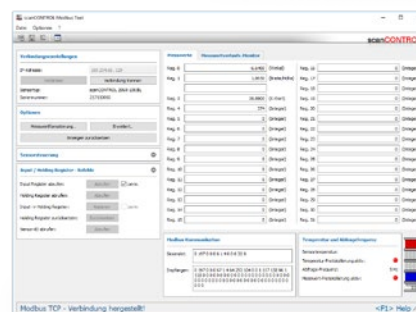

Integration of scanCONTROL sensors

SMART

PROFILE

Integration into customer software

- LLT.DLL and SDK for fast integration in /C++ or C# (NET) applications
- LabVIEW device driver
- Various example VIs (profile transmission, container mode, ...)
- Comprehensive documentation
- Linux integration
 - Based on GigE Vision/GenICam API
 - Fast integration via additional C++ library
 - Various sample programs
 - Comprehensive documentation
- Cognex VisionPro
 - AIK adapter for fast integration via Cognex AIK server
 - Cognex Range Images can be generated and processed based on the scanCONTROL measuring points
- Others on request



scanCONTROL Developer Tool

Complete integration example (demo tool)

- Source code available (QML / C++, usable for Windows and Linux)
- Serves as support for the development of own software with scanCONTROL sensors
- MouseOver over the sensor parameters directly displays the corresponding function in the LLT.DLL
- All data transmission options can be set and tested

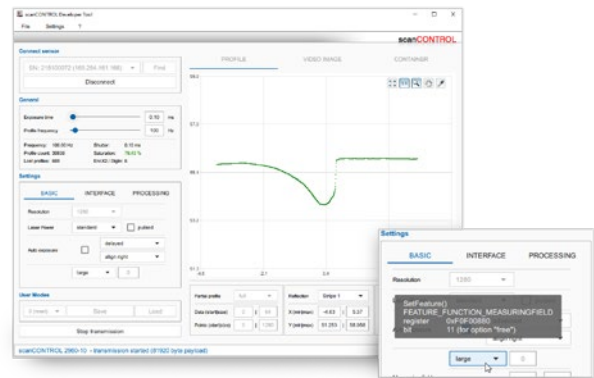

Integration into image processing software

Easy integration due to GenICam/GigE Vision standard

- Direct connection to compatible 3D and image processing software possible
- Sensor is recognized by the standard and parameters are read out directly
- scanCONTROL 25/29xx: output in 2.5D
- scanCONTROL 30xx: output in Valid3D (corresponds to coord3D data formats)

Easy integration due to GigE Vision standard

- 3D comparisons and measurement
- Integration into various software solutions via GigE Vision possible
- Detection of fine surface defects
- OCR/text recognition independent of contrast
- Completeness, position detection, planarity, ... and much more!

GEN*i*CAM **GigE VISION**

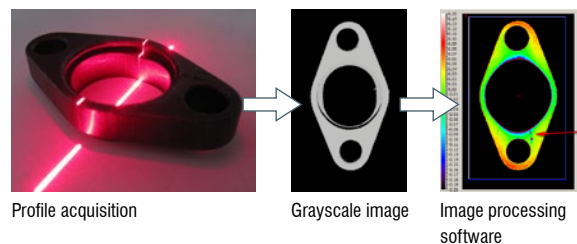

Software 3DInspect

Intuitive user interface

Real 3D evaluation, not just 2.5D

Object extraction in 3D

Direct feedback with algorithms

Compatible with all 3D sensors
from Micro-Epsilon

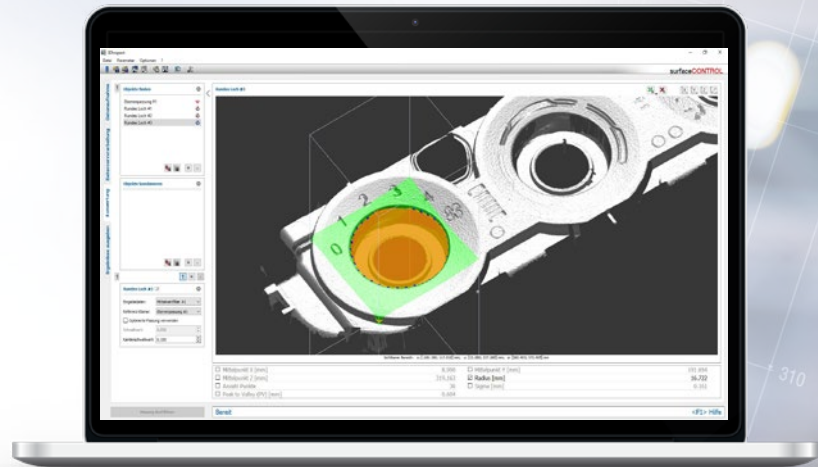

3DInspect

3DInspect software for 3D measurement and inspection tasks

The 3DInspect software is a powerful tool for sensor parameter set up and industrial measurement tasks. This software transmits the measurement data from the sensor via Ethernet and provides the data in three-dimensional form. The 3D data is then further processed on the PC using 3DInspect measurement programs, evaluated, assessed and, if necessary, logged and transmitted to a control unit via Ethernet. The 3D data can also be saved with the software. In addition to the scanCONTROL 30xx models, the 3DInspect software is also supported by the 3D Profile Unit and the surfaceCONTROL and reflectCONTROL sensors.

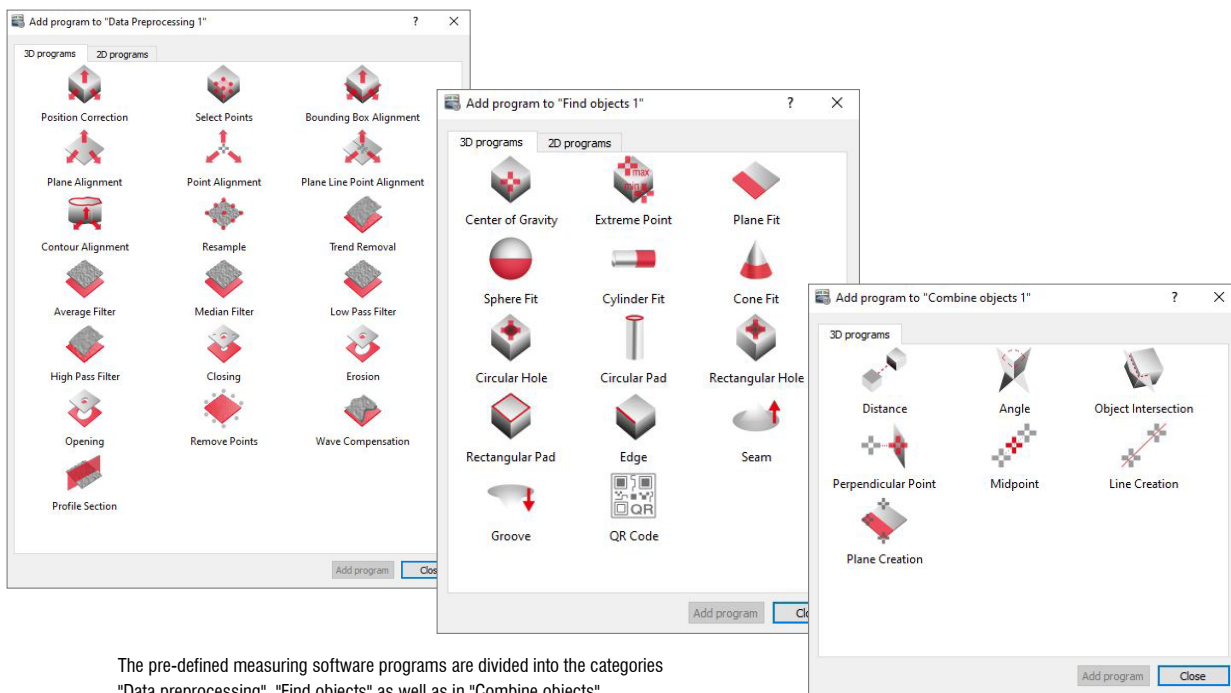

The pre-defined measuring software programs are divided into the categories "Data preprocessing", "Find objects" as well as in "Combine objects".



**Industrial Performance Unit:
Industrial PC with GigE Vision Sensors**

The Industrial Performance Unit is a powerful computing platform for 3D applications. The scanner can be parameterized directly via the 3DInspect software, allowing measurements to be started immediately. Results can be output via the integrated interfaces RPOFINET, EtherCAT and EtherNet/IP.

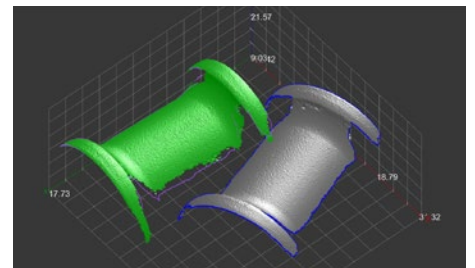
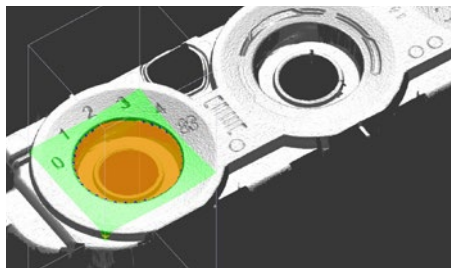
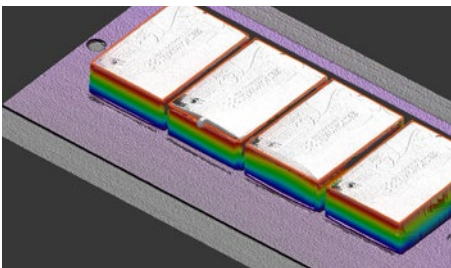
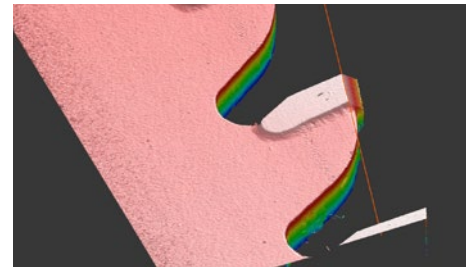
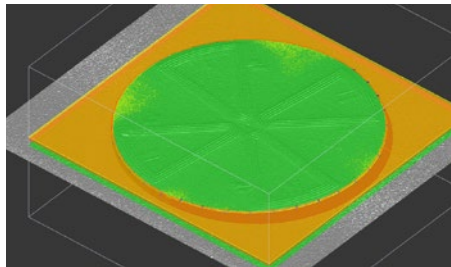
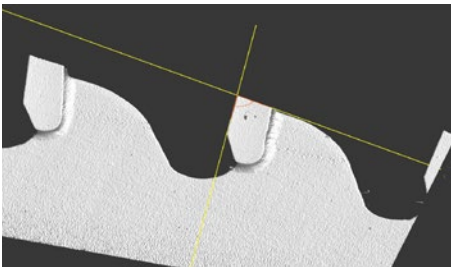
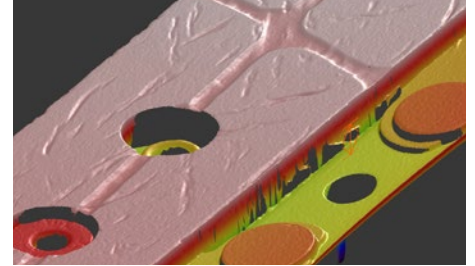
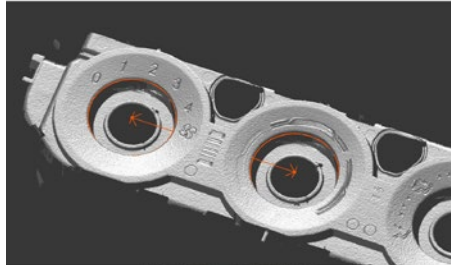
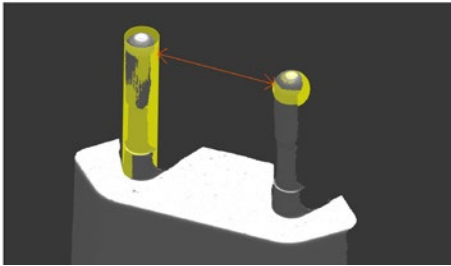

Valid3D technology from Micro-Epsilon vs. conventional 2.5D systems

The unique Valid3D technology enables lossless display and processing of the point clouds. This is how scanned 3D objects can be moved arbitrarily in the coordinate system.

Valid3D: Real 3D without data loss

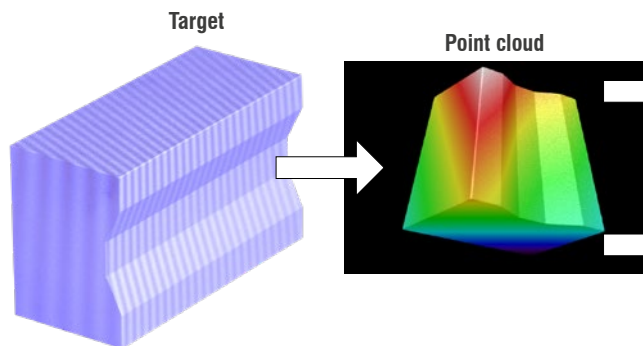

Point cloud after turn

3DInspect with Valid3D

- Real 3D image of test object without data loss
- Analysis and evaluation of complete test object

Common 3D software

- Algorithms based on 2.5D
- Only one z-coordinate per x/y coordinate possible
- Data loss during data processing

System for multi-scanner applications

3D Profile Unit



micro-epsilon.com/3DPU

Profile stitching for up to 2 sensors

3D Profile Unit Controller

Powerful industrial computer

- Communication with any GigE Vision clients
- Direct integration into image processing software
- Transfer of profile data or 3D point clouds
- Data evaluation and system parameterization is implemented in the 3DInspect software
- Optionally available with Industrial Ethernet:
 - Integrated evaluation
 - Transfer of measured values to PLC
 - Industrial Ethernet interface for control and transfer of measured values

NEW



**SMART
PROFILE**



Application examples:

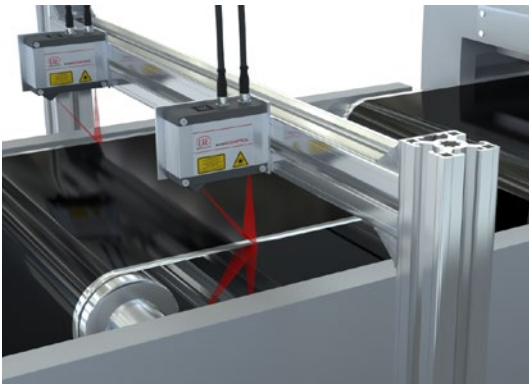

Width, thickness and Heavy Edge of battery film

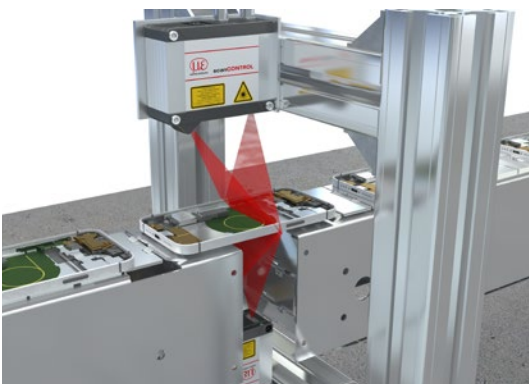
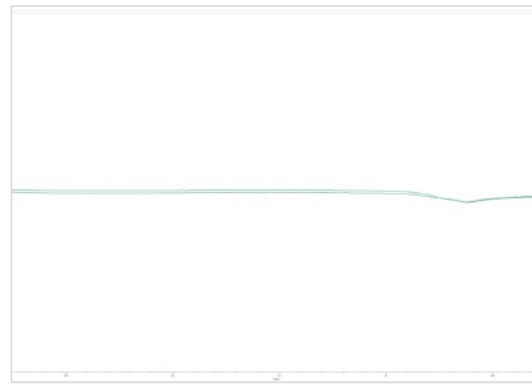

Thickness of smartphone carrier plates

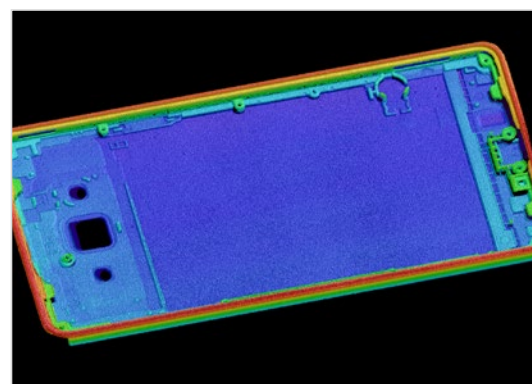

Stitched 3D point cloud of the smartphone carrier plate in 3DInspect

Accessories

scanCONTROL

2D/3D Gateway

PROFINET / EtherCAT / EtherNet/IP for all **SMART** scanners

One 2D/3D Gateway is connectable with up to 4 sensors. Operation of more than one sensor requires a switch. The 2D/3D Gateway communicates with the scanCONTROL SMART sensor via Ethernet Modbus.

The resultant values are then converted to PROFINET, EtherCAT or EtherNet/IP. The customer carries out the parameter setup with a detailed instruction manual. The gateway can also be parameterized in advance at the factory.

Models

6414142 2D/3D Gateway

Fieldbus coupler, configurable for PROFINET, EtherNet/IP and EtherCAT

6414142.001 2D/3D Gateway, pre-parameterized,

Pre-parameterized to customer log and IP addresses

Number of sensors on the gateway	Maximum measurement frequency
1	500 Hz
2	500 Hz
3	330 Hz
4	250 Hz

NEW

Higher measurement frequencies are also possible with the 30xx series due to the Modbus bundling option.

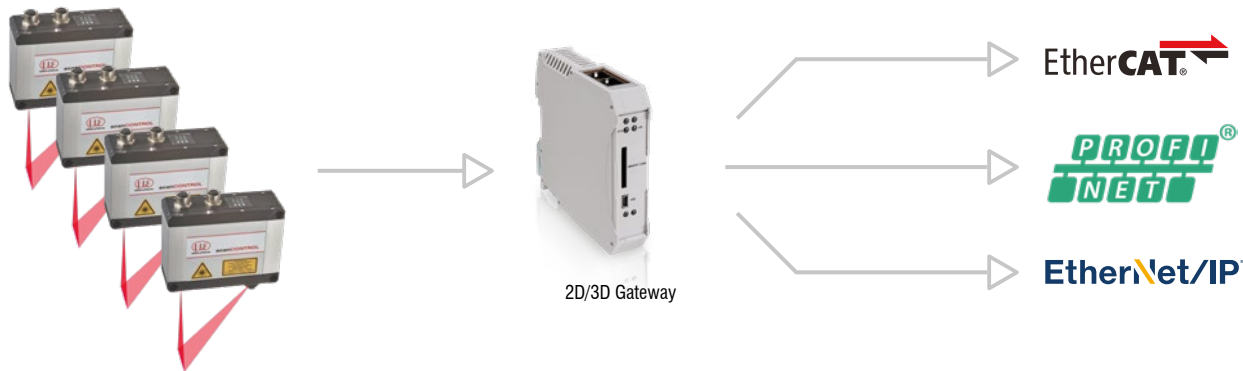

2D/3D Output Unit

Analog signals / digital switch signals for all **SMART** scanners

The 2D/3D Output Unit is addressed via Ethernet and outputs analog and digital signals. Different output terminals can be connected to the fieldbus coupler.

Models

6414073 2D/3D Output Unit Basic/ET

Fieldbus coupler with filter module and bus end terminal

0325131 OU-DigitalOut/8-channel/DC24V/0.5A/negative

8-channel digital output terminal; DC 24 V; 0.5 A; negative switching

0325115 OU-DigitalOut/8-channel/DC24V/0.5A/positive

8-channel digital output terminal; DC 24 V; 0.5 A; positive switching

0325116 OU-AnalogOut/4-channel/±10 V

4-channel analog output terminal; ±10 V

0325135 OU-AnalogOut/4-channel/0-10 V

4-channel analog output terminal; 0-10 V

0325132 OU-AnalogOut/4-channel/0-20 mA

4-channel analog output terminal; 0-20 mA

0325133 OU-AnalogOut/4-channel/4-20 mA

4-channel analog output terminal; 4-20 mA

Other terminals available on request.



Housings for protection and cooling for LLT30xx

for the measuring ranges 25 - 200 mm

Protective housing with blow-out system

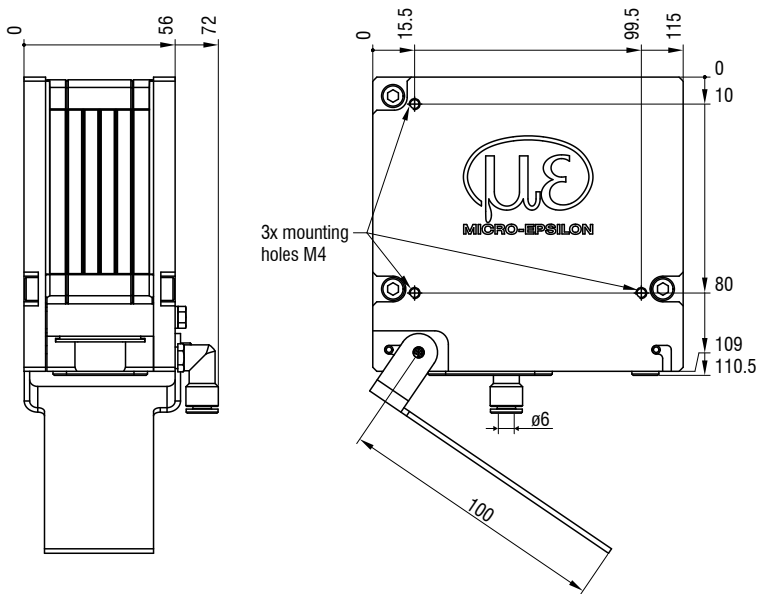

Protective housing with blow-out system and water cooling

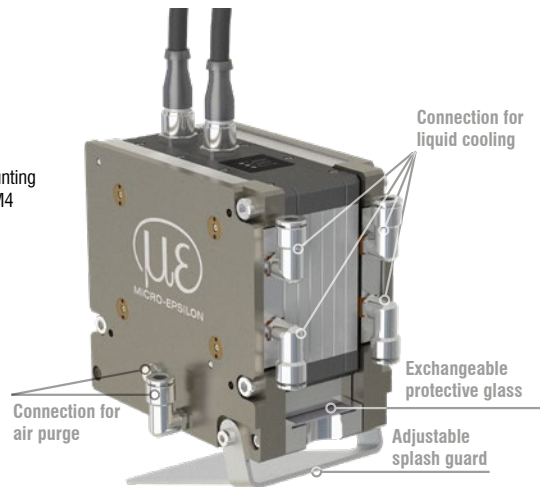
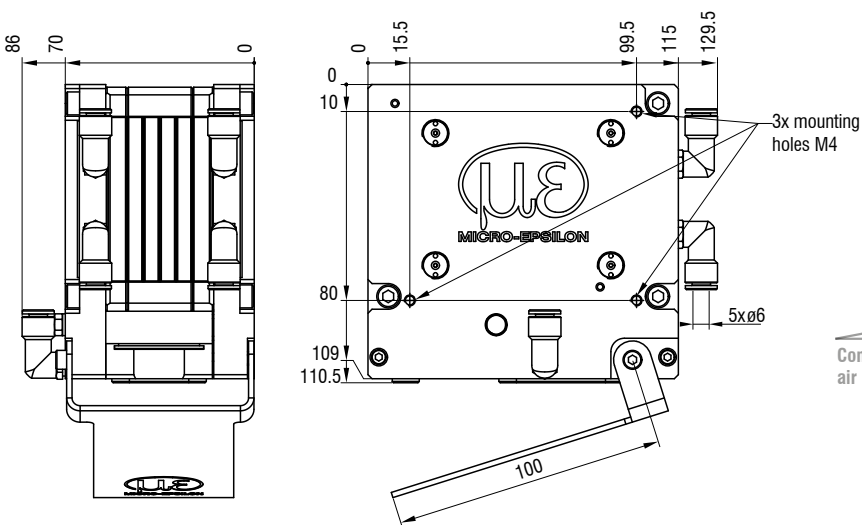

Art. no. Model

- 2105076 Protective housing for LLT30
- 2105077 Protective cooling housing for LLT30
- 0755083 Exchangeable glass for protective housing LLT30

Description

- Adaptive protective housing for LLT30
- Adaptive protective and cooling housing for LLT30
- Exchangeable glass for protective / cooling concept LLT30, pack of 30 pieces

Connection cables

PCR3000-x Multi-function cable

Cable for power supply, digital inputs (TTL or HTL), RS422 (half-duplex); suitable for drag chains and robots
Cable length (m): 2 / 5 / 10 / 15 / 20 / 25 / 35



SCR3000A-x Ethernet connection cable

Cable for parameter setting, value and profile transmission; suitable for drag chains and robots
Cable length (m): 0.5 / 2 / 5 / 10 / 15 / 20 / 25 / 35

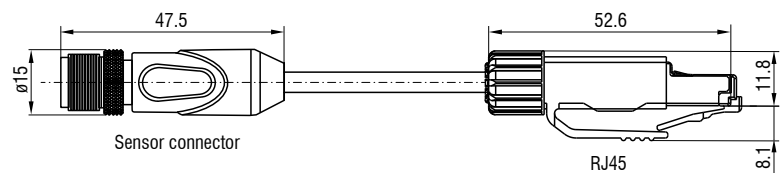

Other accessories

Art. no. Model

0323478 Connector/12-pin/Multifunction for LLT25/29/30 series
0323479 Connector/8-pin/Ethernet for LLT25/29/30 series
2420067 PS25/29/30
0254111 Case for LLT25/29/30 (up to MR 200)
0254153 Case for LLT30 series, MR 430/600
2960097 Measuring stand for LLT25/26/29/30 series
2960115 Measuring stand for LLT30 series, MR 430/600

Description

Plug for multifunction port
Plug for Ethernet socket
Power supply unit for scanCONTROL
Transport case for scanCONTROL sensors incl. measuring stand
Transport case for scanCONTROL sensors incl. measuring stand
Measuring stand with sensor adapter board, flexible rod and clamp base
Measuring stand with sensor adapter board, flexible rod and clamp base

Sensors and Systems from Micro-Epsilon



Sensors and systems for displacement, distance and position



Sensors and measurement devices for non-contact temperature measurement



Measuring and inspection systems for metal strips, plastics and rubber

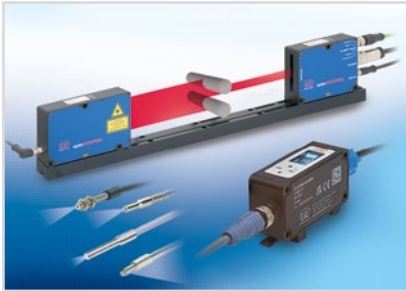

Optical micrometers and fiber optics, measuring and test amplifiers



Color recognition sensors, LED analyzers and inline color spectrometers



3D measurement technology for dimensional testing and surface inspection

