







More Precision

induSENSOR // Linear inductive displacement sensors



Gauge with external controller for series applications

induSENSOR DTA (LVDT)

-  Proven LVDT technology
-  Measuring ranges $\pm 1 \dots \pm 10$ mm
-  Low cost especially for series applications
-  Sensor diameter of only $\varnothing 8$ mm
-  Models with pneumatic push

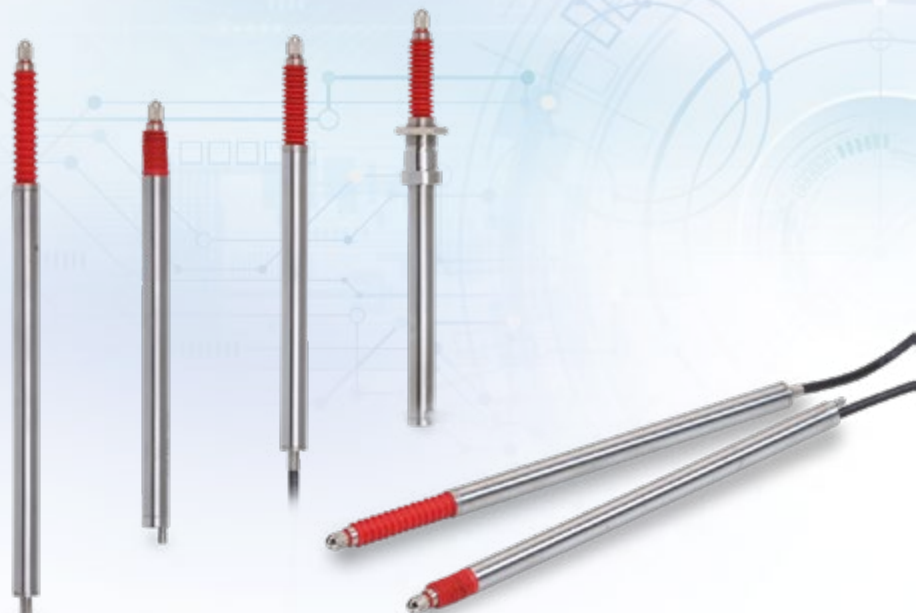

LVDT gauge sensors DTA-xG8 are primarily used for the precise measurement and inspection of workpiece geometry (e.g. length, width, diameter, thickness, depth, height). Therefore, different measuring ranges from ± 1 mm to ± 10 mm are available. The gauges are particularly suitable for applications involving a large number of pieces.

These gauges have an axial cable outlet and are equipped with either a plain bearing-guided plunger and a return spring, or with a pneumatic push rod. Depending on the measuring object, different probe tips are available.

DTA gauges can be operated with every MSC controller. Depending on this controller, single-/dual-/multi-channel measurements are possible. In addition to the well-established analog output, modern fieldbuses are available for integration purposes.

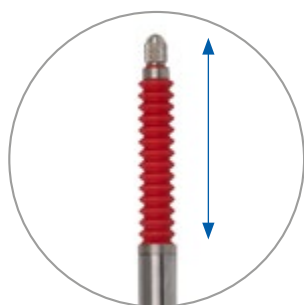

Plunger with spring



Based on modern interfaces and multi-channel capability, the MSC controllers open up new fields of application.

Article designation

DT	A	-5	-G8	-3	-CA	-V
Gauge options: V: Pneumatic feed						
Connection (axial): CA Integrated cable (3 m)						
Linearity: 3 ($\pm 0.3\%$)						
Function: gauge						
Measuring range in mm						
Excitation AC						
Principle: Differential Transformer (LVDT)						



Model	DTA-1G8	DTA-3G8	DTA-5G8	DTA-10G8	DTA-1G8-V	DTA-3G8-V	DTA-5G8-V	DTA-10G8-V
Measuring range	± 1 mm	± 3 mm	± 5 mm	± 10 mm	± 1 mm	± 3 mm	± 5 mm	± 10 mm
Linearity ^[1]	≤ ± 6 μm	≤ ± 18 μm	≤ ± 30 μm	≤ ± 60 μm	≤ ± 6 μm	≤ ± 18 μm	≤ ± 30 μm	≤ ± 60 μm
	≤ ± 0.3 % FSO							
Repeatability ^[2]	≤ 0.15 μm	≤ 0.45 μm	≤ 0.75 μm	≤ 1.5 μm	≤ 0.15 μm	≤ 0.45 μm	≤ 0.75 μm	≤ 1.5 μm
Temperature stability	≤ 250 ppm FSO/K							
Sensitivity	133 mV / mm/V	85 mV / mm/V	53 mV / mm/V	44 mV / mm/V	133 mV / mm/V	85 mV / mm/V	53 mV / mm/V	44 mV / mm/V
Excitation frequency	5 KHz	5 KHz	5 KHz	2 KHz	5 KHz	5 KHz	5 KHz	2 KHz
Excitation voltage	550 mV							
Connection	integrated cable 3 m with open ends; axial cable outlet; drag chain suitable; cable diameter 3.1 mm; min. bending radii: fixed installation 25 mm, moving 38 mm, drag chain 47 mm							
Temperature range	Storage	-40 ... +80 °C						
	Operation	-20 ... +80 °C (without bellows); 0 ... +80 °C (with bellows)						
Pressure resistance	Atmospheric pressure							
Shock (DIN EN 60068-2-27)	40 g / 6 ms in 3 axes, 1000 shocks each							
Vibration (DIN EN 60068-2-6)	± 1.5 mm / 10 ... 58 Hz in 2 axes, 10 cycles each ± 20 g / 58 ... 500 Hz in 2 axes, 10 cycles each							
Protection class (DIN EN 60529)	IP65 (with bellows); IP54 (without bellows)							
Material	Stainless steel (housing); FPM (bellows); PUR (cable sheath); PVC/PP (cable braids)							
Weight	approx. 70 g	approx. 70 g	approx. 75 g	approx. 85 g	approx. 70 g	approx. 70 g	approx. 80 g	approx. 85 g
Typ. spring forces ^[3]	SMR	1.3 N	0.8 N	1.0 N	0.7 N	depending on air pressure		
	MMR	1.55 N	1.5 N	1.9 N	1.9 N			
	EMR	2.0 N	2.5 N	3.0 N	3.5 N			
Compatibility	MSC7401, MSC7802, MSC7602							
Typ. service life	5 million cycles							

^[1] Independent linearity

^[2] 200 repetitions; each repetition averaged over 100 values

^[3] Removing the bellows changes the spring forces

DTA-xG8-3-CA

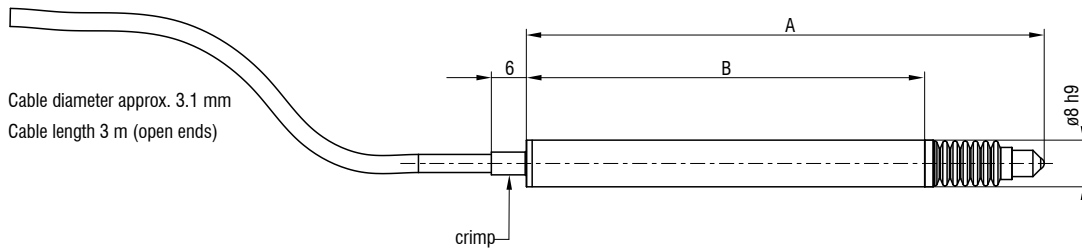

Model	A (zero position)	B
DTA-1G8-3-CA	82.8 mm	64.3 mm
DTA-3G8-3-CA	88.2 mm	68.3 mm
DTA-5G8-3-CA	118.0 mm	89.5 mm
DTA-10G8-3-CA	155.0 mm	121.7 mm

DTA-xG8-3-CA-V

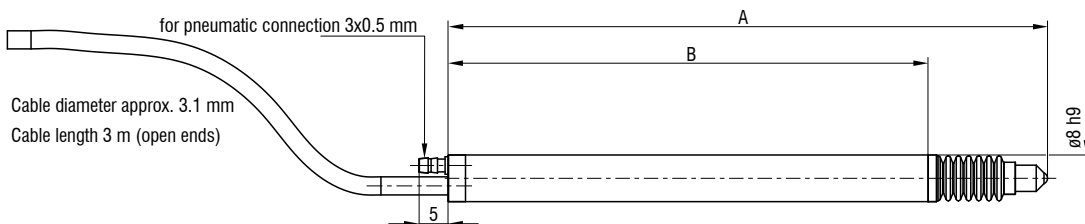

Model	A (zero position)	B
DTA-1G8-3-CA-V	94.8 mm	76.3 mm
DTA-3G8-3-CA-V	102.8 mm	82.3 mm
DTA-5G8-3-CA-V	134.0 mm	105.3 mm
DTA-10G8-3-CA-V	171.0 mm	137.3 mm

Dimensions in mm, not to scale

Mounting options and accessories

induSENSOR DTA (LVDT)

Sensor cables

- C701-3 Sensor cable, 3 m, with cable connector and tin-plated free ends
- C701-6 Sensor cable, 6 m, with cable connector and tin-plated free ends
- C701/90-3 Sensor cable, 3 m, with 90° cable connector and tin-plated free ends
- IF7001 Single-channel USB/RS485 converter for MSC7xxx
- PC5/5-IWT Power supply and output cable, 5 m, M12x1, 5-pin.

Cable connector C701

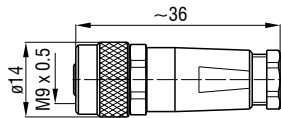

Angle socket C701/90

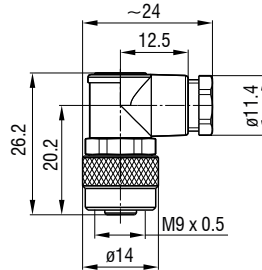

Socket PC5/5

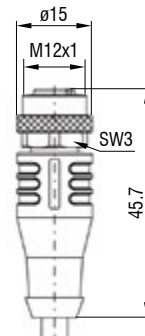

Service:

- 2981016 Connector assembly M9 and cable reduction
XXXX mm - DTA-x
- 2980017 Connector assembly M9 - DTA-x
- 2981024 Assembly of screw flange - DTA-xG8

Connector assembly M9
(see page 34/35)

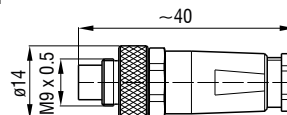

Screw flange

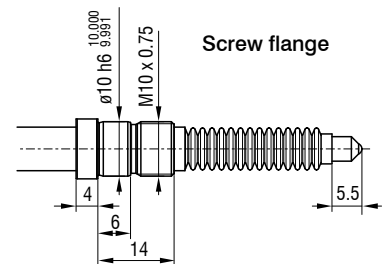

Probe tips

- Type 2 probe tip / hard metal
- Type 2 probe tip / plastics
- Type 2 probe tip / ruby
- Type 2 probe tip / steel
- Type 10 probe tip / steel
- Type 11 probe tip / steel
- Type 13 probe tip / steel

Standard probe tip: type 2

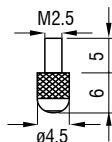

Option: type 10

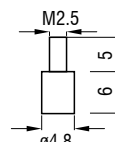

Option: type 11

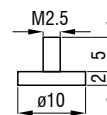

Option: type 13

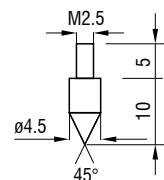

Sensor Mounting

- 0487087 MBS12/8 Mounting block Sensor mounting for circumferential clamping ø12 mm
- 0487049 MBS12/8 adapter ring For reduction to ø8 mm
- 2966054 Clamping flange for DTA-xG8 For clamping in a defined hole

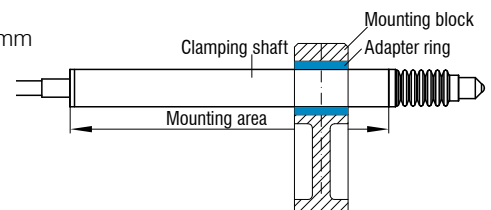

Mounting block MBS12/8

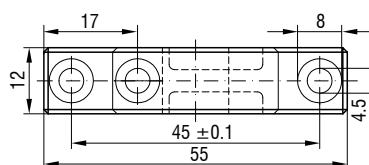
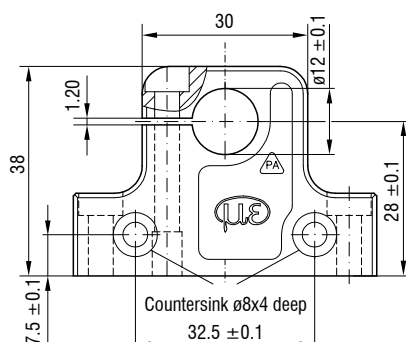

Adapter ring

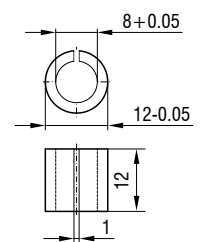

Applications

induSENSOR DTA (LVDT)

Gauges from Micro-Epsilon have many possible fields of application. Due to different measuring ranges and configuration settings, the gauges are suitable for numerous measurement and inspection tasks. Combined with multi-channel controllers, the DTA gauges are often

used for dimensional measurement and inspection tasks, e.g., in automated quality control, R&D and production monitoring.

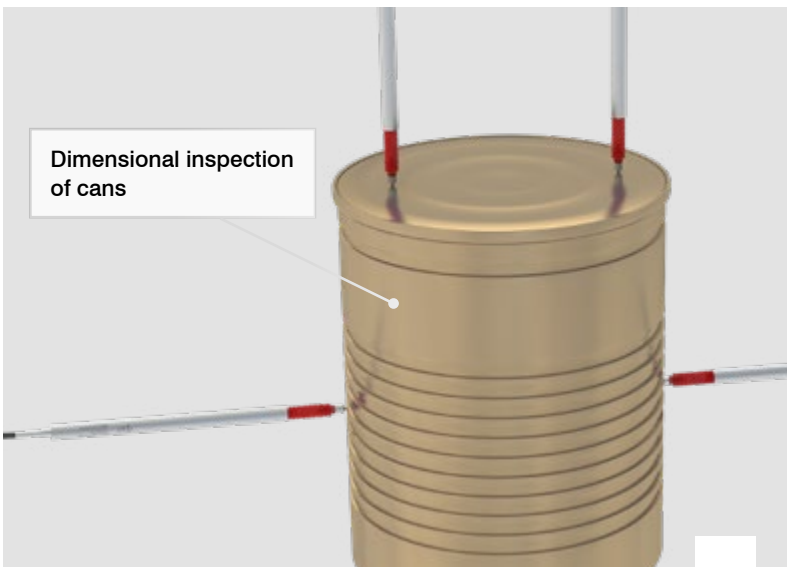
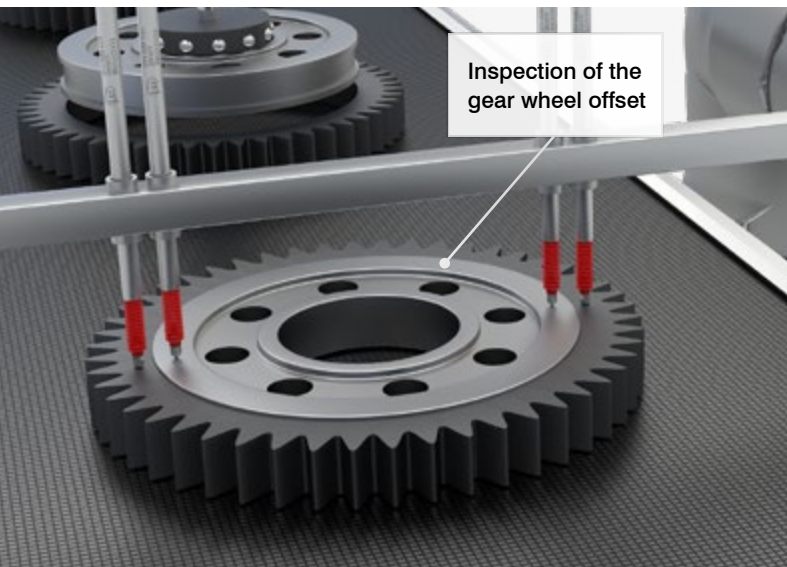
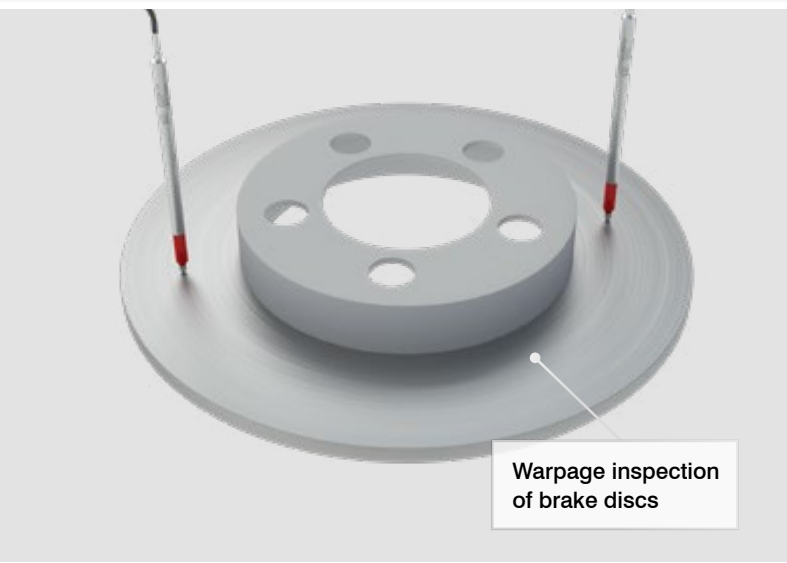
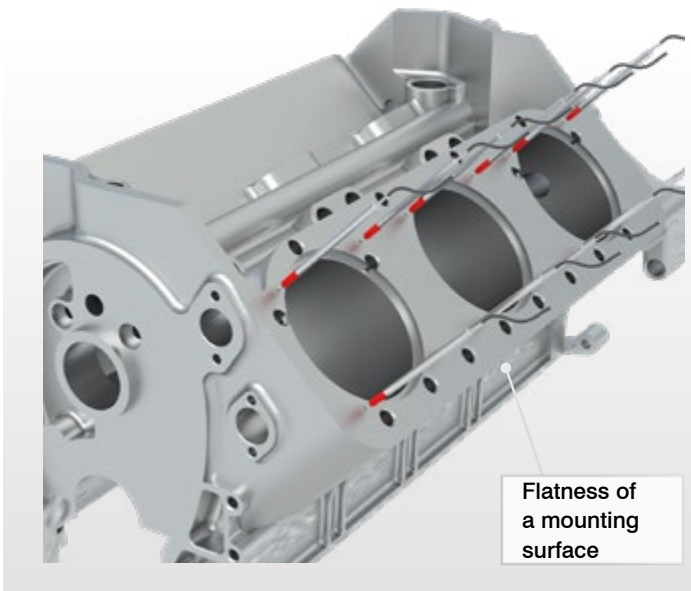

Accessories and connection possibilities

induSENSOR MSC

Accessories for MSC7401 / MSC7602 / MSC7802

Connection cables

- PC7400-6/4 Supply and output cable, 6 m
- PC5/5-IWT Supply and output cable, 5 m (only MSC7401 / MSC7802)
- IF7001 Single-channel USB/RS485 converter for MSC7xxx
- MSC7602 connector kit



MSC7602 connector kit

Service

Connection, adjustment and calibration including manufacturer certificate

Interface modules

- IF2035-EIP DIN rail interface module for Ethernet/IP (multi-channel)
- IF2035-PROFINET DIN rail interface module for PROFINET (multi-channel)
- IF2035-EtherCAT DIN rail interface module for EtherCAT (multi-channel)
- IF1032/ETH Interface module for Ethernet/EtherCAT (single channel) (only MSC7401 / MSC7802)

Power supply units

- PS2401/100-240/24V/1A Universal power supply unit with open ends

Connection options MSC7401

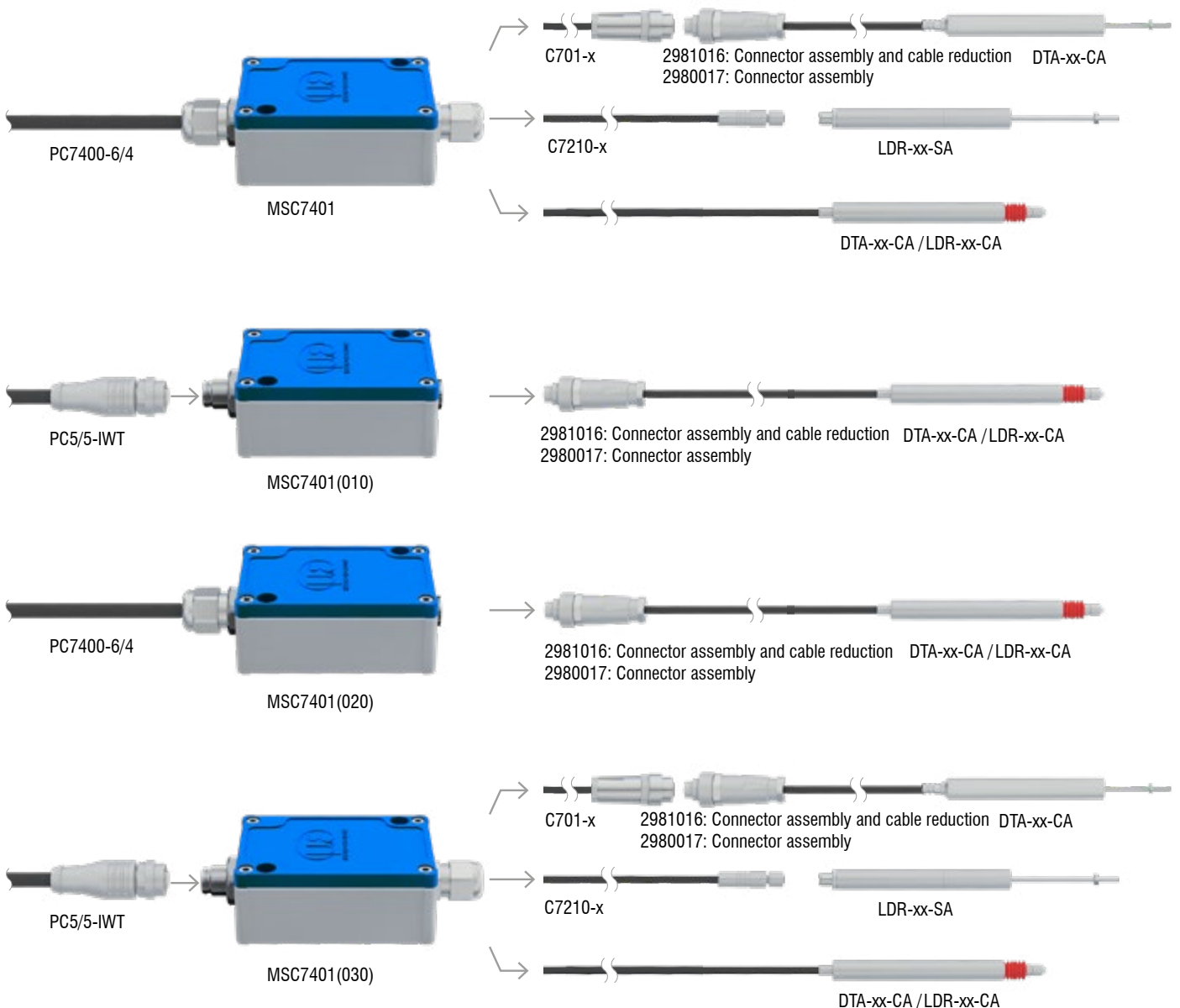

Connection options MSC7802

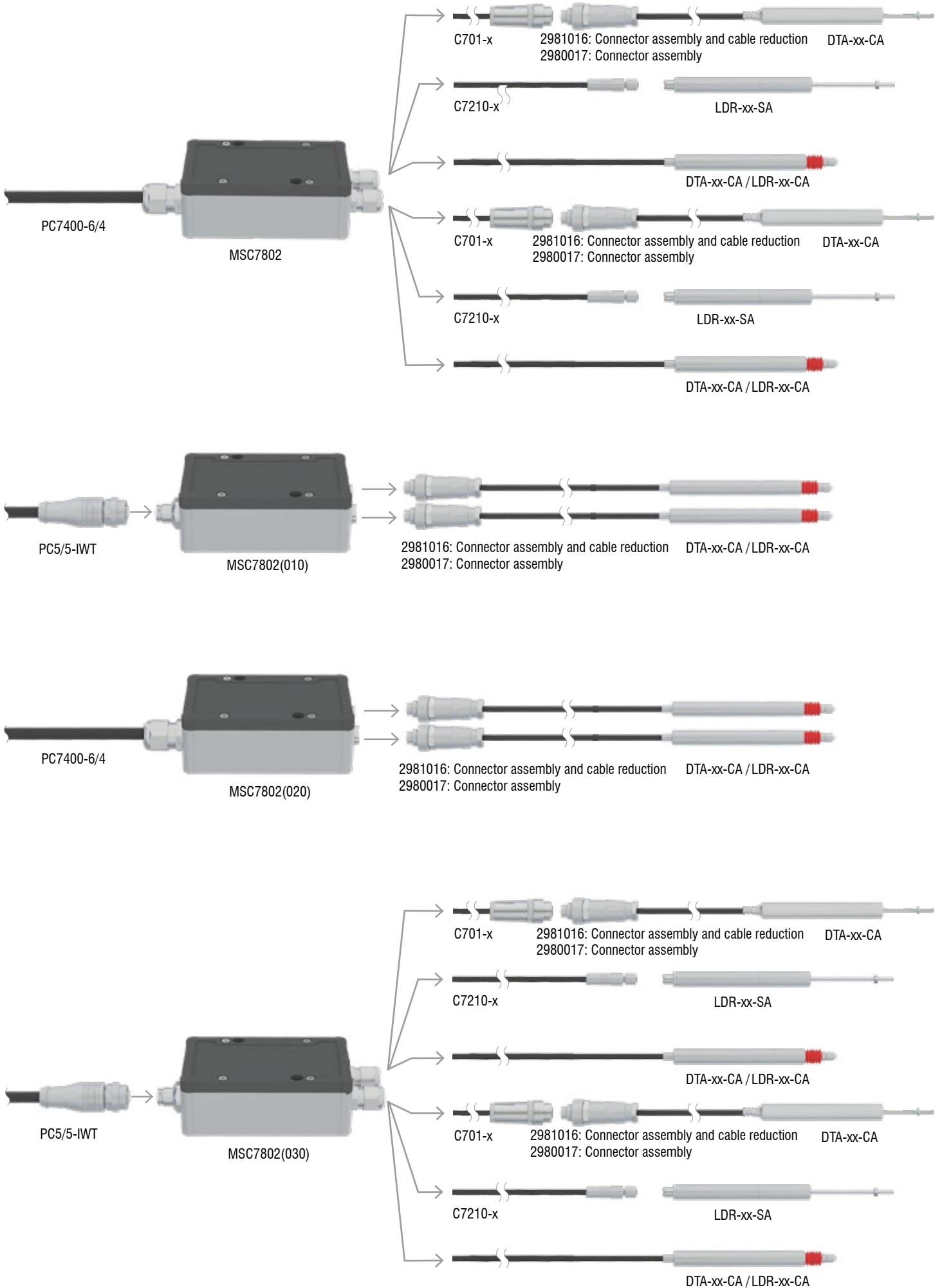

Technology and measuring principle

induSENSOR

LVDT Gauges and LVDT displacement sensors (DTA series)

LVDT displacement sensors and gauges (Linear Variable Differential Transformer) are constructed with a primary and two secondary coils, which are arranged symmetrically to the primary winding. As a measuring object, a rod shaped soft-magnetic core can be moved within the differential transformer. An electronic oscillator supplies the primary coil with an alternating current of constant frequency. The excitation is an alternating voltage with an amplitude of a few volts and a frequency between 1 and 10 kHz.

Depending on the core position, alternating voltages are induced in the two secondary windings. If the core is located in its "zero position", the coupling of the primary to both secondary coils is equally large. Movement of the core within the magnetic field of the coil causes a higher voltage in one secondary coil and a lower voltage in the second coil. The difference between the two secondary voltages is proportional to the core displacement. Due to the differential design of the sensor, the LVDT series has an output signal which is very stable.

Signal LVDT sensor

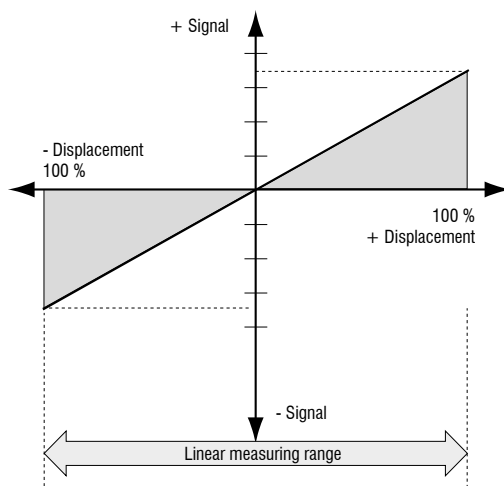

Measuring principle gauging sensor

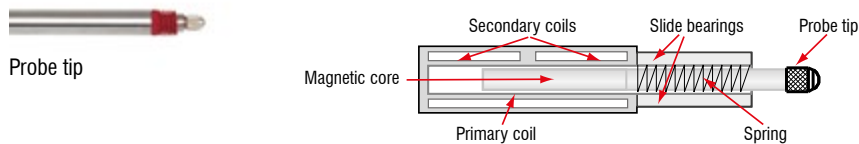

Measuring principle displacement sensor

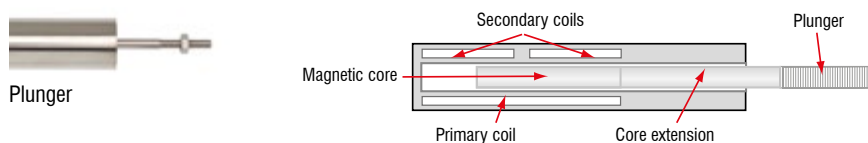

LDR Displacement sensors

The inductive sensors in the LDR series are constructed as half-bridge systems with center tap. An unguided plunger moves in the interior of the sensor coil, which consists of symmetrically constructed winding compartments. The plunger is joined to the moving measuring object via a thread.

Due to the movement of the plunger within the coil, an electrical signal is produced which is proportional to the displacement covered. The specific sensor configuration facilitates a short, compact design with a small diameter. Three connections are required as an interface to the sensor.

Block diagram LDR series

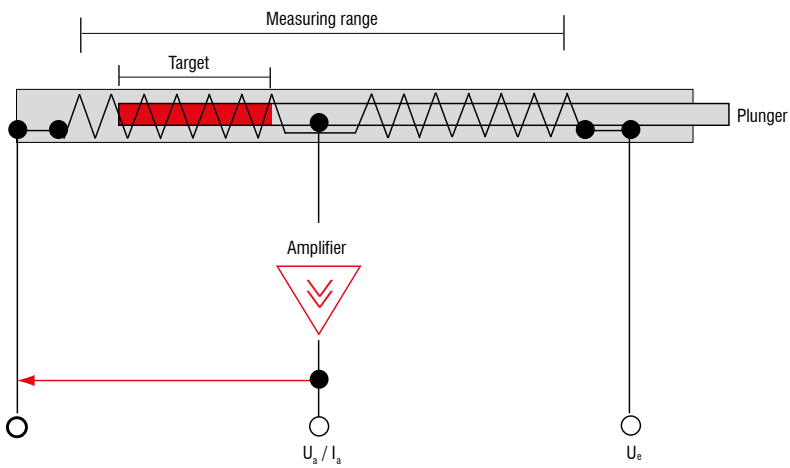

Technology and measuring principle

induSENSOR

Independent and absolute linearity of LVDT sensors

Please consider that with LVDT sensors, two kinds of linearity must be distinguished:

With the independent linearity, an individual linearity characteristic is determined for the recorded sensor signal of each sensor. It describes the deviation of the recorded sensor signal from the individually calculated reference line (red, see figure). The maximum deviation (d) must not exceed the values specified in the datasheet.

With the absolute linearity, a new straight line is laid through two fixed points during the adjustment which may cause the gradient of the reference line to change. Therefore, the recorded values of the sensor signal may deviate more from the new line (blue) than is the case with the independent linearity (see figure), and also exceed the values specified in the datasheet.

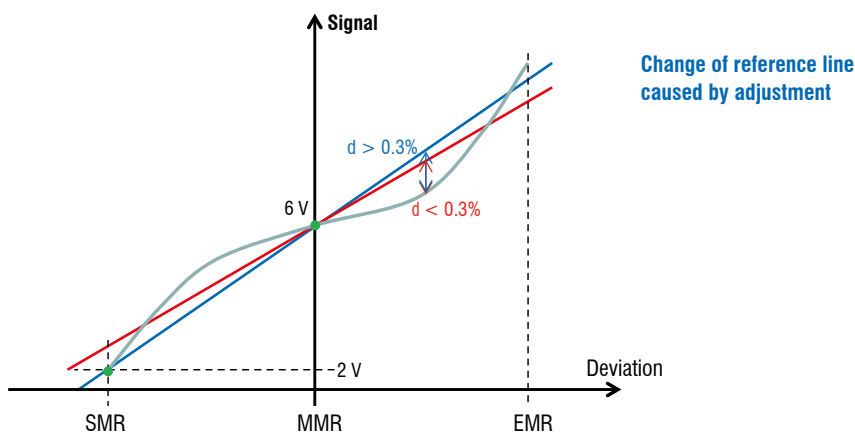
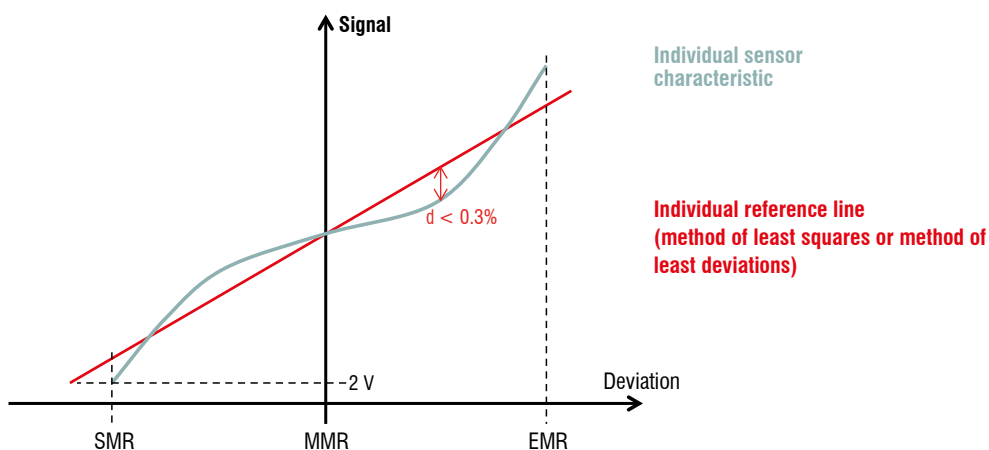

Sensors and Systems from Micro-Epsilon



Sensors and systems for displacement, position and dimension



Sensors and measurement devices for non-contact temperature measurement



Measuring and inspection systems for quality assurance



Optical micrometers, fiber optics, measuring and test amplifiers



Color recognition sensors, LED Analyzers and inline color spectrometers



3D measurement technology for dimensional testing and surface inspection