



# More Precision

**confocalDT** // Confocal chromatic sensor system



# New products





## confocalDT

**NEW** Compact confocal chromatic controllers for industrial series applications

The new IFC2412 and IFC2417 confocal controllers are now available as 2-channel versions of the ultra-compact IFC2411 and IFC2416 controllers. The IFC2412 has two channels with an adjustable measuring rate of 8 kHz and a submicrometer resolution of up to 1 nm. The IFC2417 with its two channels has a measuring rate of 25 kHz and is also able to perform multi-peak measurements with up to 5





layers. An active exposure regulation of the CCD line enables fast and reliable measurements on varying surfaces. Both controllers feature integrated interfaces such as Ethernet, EtherCAT and two analog outputs.

### confocalDT IFC2411 / IFC2412

-  Most compact confocal controller on the market
-  Nanometer resolution for precise distance and thickness measurements
- INTERFACE** Flexible integration via Ethernet, RS422 or analog output (U/I)
-  Direct PLC connection due to Industrial Ethernet
- IP40** Robust aluminum housing (IP40)
-  Excellent price-performance ratio



### confocalDT IFC2416 / IFC2417



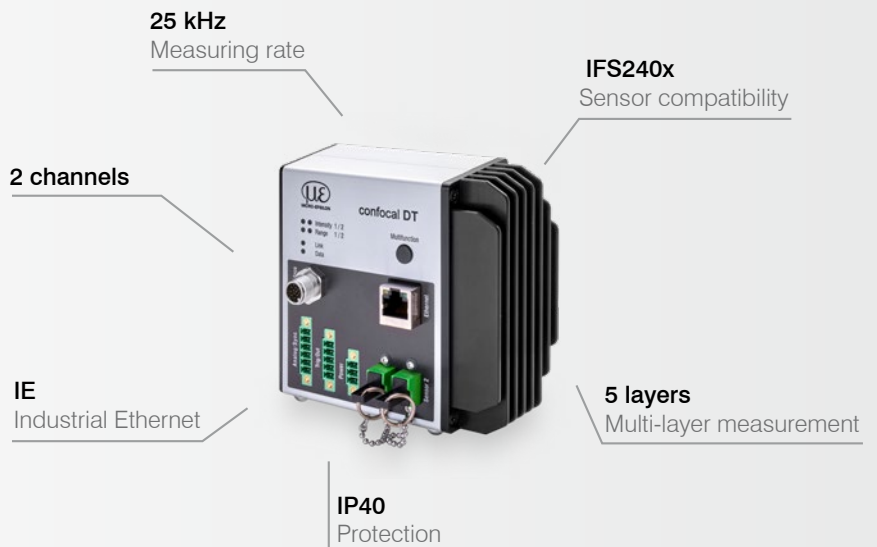



-  Nanometer resolution for highest precision
-  Ideal for extremely fast distance and thickness measurements up to 25 kHz
-  Multi-peak: up to 5 layers with one measurement
-  Best signal quality and stability due to high light intensity
- INTERFACE** Flexible integration via Ethernet, RS422 or analog output
- IP40** Compact design and robust IP40 aluminum housing



More details from p. 36.

# Compact confocal chromatic controllers for industrial series applications

## confocalDT IFC2411 / IFC2412

-  Most compact confocal controller on the market
-  Nanometer resolution for precise distance and thickness measurements
-  **INTERFACE** Flexible integration via Ethernet, RS422 or analog output (U/I)
-  Direct PLC connection due to Industrial Ethernet
-  **IP40** Robust aluminum housing (IP40)
-  **Best price** Excellent price-performance ratio



### Powerful confocal chromatic controllers

The IFC2411 and IFC2412 controllers set new standards in non-contact distance and thickness measurements. The most compact confocal chromatic controllers currently available deliver impressive results with high-precision measurements at high speeds. Their unique design makes these controllers ideal for easy integration into existing plants and systems. They can be quickly mounted on a DIN rail and fit into even the smallest control cabinets.

### One controller – two channels with full performance

With the dual-channel version confocalDT IFC2412, integrated calculation functions enable the data combination of both channels, for example for thickness measurements of battery film. The measured values are recorded synchronously and at full measuring rate for both channels.

### Maximum sensor variety, numerous application options

The flexible connection of various sensors enables measurements on almost all surfaces as well as one-sided thickness measurements on transparent objects. Micro-Epsilon's extensive sensor portfolio covers measuring ranges from 0.1 mm to 30 mm. In addition, the sensors are available for use in high-temperature environments and in a vacuum.

### Developed for industrial production, OEMs and automation

Diverse interfaces enable flexible integration into machines and systems. The robust IP40 aluminum housing provides reliable protection in industrial environments for maximum precision and signal stability. These systems impress in series and OEM applications with their outstanding performance and excellent price-performance ratio.

Video signal display

Measurement chart

Presets for fast setting

### Simple operation via web interface

Setup and configuration of the controller and sensors are handled in a user-friendly web interface via Ethernet connection. No additional software is required. For thickness measurements, materials are stored in an editable materials database.

Model		IFC2411	IFC2411/IE
Resolution	Ethernet	1 nm	-
	Industrial Ethernet	-	1 nm
	RS422	18 bit	
	Analog	16 bits (teachable)	
Measuring rate	Continuously adjustable from 100 Hz to 8 kHz		
Linearity <sup>[1]</sup>	typ. < ±0.02 % FSO (depends on sensor)		
Multi-peak measurement	1 layer		
Light source	Internal white LED		
No. of characteristic curves	up to 10 characteristic curves for different sensors per channel, selection via table in the menu		
Permissible extraneous light <sup>[2]</sup>	30.000 lx		
Synchronization	yes		
Supply voltage	24 VDC ± 10 %		
Power consumption	< 7 W (24V)		
Signal input	sync-in / trig-in; 1x encoder (A+, A-, B+, B-, index)		
Digital interface <sup>[3]</sup>	Ethernet / RS422		EtherCAT / PROFINET / Ethernet/IP / RS422
Analog output	Current: 4 ... 20 mA; voltage: 0 ... 5V & 0 ... 10 V (16 bit D/A converter)		
Digital output	Sync-out		
Connection	Optical	pluggable optical fiber via E2000 socket, length 2 m ... 50 m, min. bending radius 30 mm	
	Electrical	3-pin supply terminal block; 6-pin I/O terminal block (max. cable length 30 m); 17-pin M12 connector for RS422, analog and encoder; RJ45 connector for Ethernet (max. cable length 100 m)	3-pin supply terminal block; 5-pin I/O terminal block (max. cable length 30 m); 17-pin M12 connector for RS422, analog and encoder; RJ45 connector for Industrial Ethernet (max. cable length 100 m)
Mounting	free-standing, DIN rail mounting		
Temperature range	Storage	-20 ... +70 °C	
	Operation	+5 ... +50 °C	
Shock (DIN EN 60068-2-27)	15 g/6 ms on XYZ axis, 1000 shocks each		
Vibration (DIN EN 60068-2-6)	2 g / 20 ... 500 Hz in XYZ axis, 10 cycles each		
Protection class (DIN EN 60529)	IP40		
Material	Aluminum		
Weight	approx. 335 g		
Compatibility	compatible with all confocalDT sensors		
No. of measurement channels	1		
Control and indicator elements	Web interface for setup and settings; Multifunction button: interface selection, adjustable functions and reset to factory settings after 10 s; 4x color LEDs for intensity, range, link and data		Web interface for setup and settings; Multifunction button: interface selection, adjustable functions and reset to factory settings after 10 s; 4x color LEDs for Intensity, Range, RUN and ERR

<sup>[1]</sup> FSO = Full Scale Output

<sup>[2]</sup> Illuminant: light bulb

<sup>[3]</sup> The controller can also be parameterized via Ethernet

# Compact confocal chromatic controllers for industrial series applications

## confocalDT IFC2411 / IFC2412

Model		IFC2412	IFC2412/IE
Resolution	Ethernet	1 nm	-
	Industrial Ethernet	-	1 nm
	RS422	18 bit	18 bit
	Analog	16 bits (teachable)	16 bits (teachable)
Measuring rate	Continuously adjustable from 100 Hz to 8 kHz		
Linearity <sup>[1]</sup>	typ. < ±0.02 % FSO (depends on sensor)		
Multi-peak measurement	1 layer		
Light source	Internal white LED		
No. of characteristic curves	Storage of up to 10 characteristic curves for different sensors per channel, selection via table in the menu		
Permissible ambient light <sup>[2]</sup>	30.000 lx		
Synchronization	yes		
Supply voltage	24 VDC ± 10 %		
Power consumption	< 9 W (24V)		
Signal input	Sync-In / trig-In; 2 encoders (A+, A-, B+, B-, Index)   3 encoders (A+, A-, B+, B-)		
Digital interface	Ethernet / RS422		EtherCAT / RS422
Analog output	2x freely selectable (16 bit D/A converter) Current: 4 ... 20 mA; voltage: 0 ... 5 V & 0 ... 10 V		
Digital output	Sync-out		
Connection	Optical	pluggable optical fiber via E2000 socket, length 2 m ... 50 m, min. bending radius 30 mm	
	Electrical	3-pin supply terminal block; 5-pin terminal for Out/Trig; 6-pin I/O terminal block (max. cable length 30 m); 17-pin M12 connector for RS422, analog and encoder; RJ45 connector for Ethernet) (max. cable length 100 m)	
Mounting	free-standing, DIN rail mounting		
Temperature range	Storage	-20 ... +70 °C	
	Operation	+5 ... +50 °C	
Shock (DIN EN 60068-2-27)	15 g/6 ms on XYZ axis, 1000 shocks each		
Vibration (DIN EN 60068-2-6)	2 g / 20 ... 500 Hz in XYZ axis, 10 cycles each		
Protection class (DIN EN 60529)	IP40		
Material	Aluminum		
Weight	670 g	670 g	
Compatibility	compatible with all confocalDT sensors		
No. of measurement channels	2		2
Control and indicator elements	Web interface for setup and settings; Multifunction button: interface selection, adjustable functions and reset to factory settings after 10 s; 4x color LEDs for intensity, range, link and data		Web interface for setup and settings; Multifunction button: interface selection, adjustable functions and reset to factory settings after 10 s; 4x color LEDs for Intensity, Range, RUN and ERR

<sup>[1]</sup> FSO = Full Scale Output

<sup>[2]</sup> Illuminant: light bulb

# Dimensions

(in mm, not to scale)

## confocalDT IFC2411

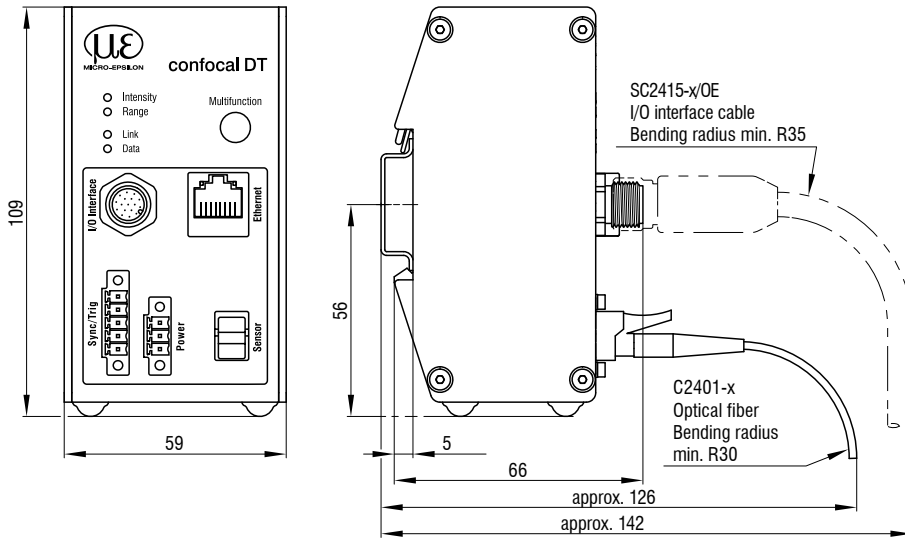

## confocalDT IFC2412

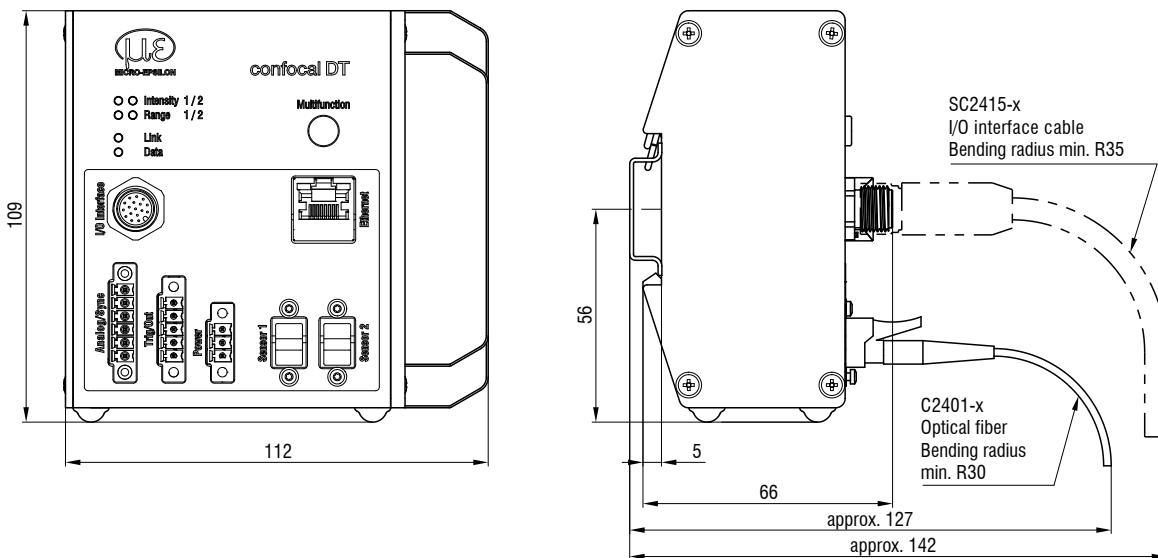

# Connection possibilities

## confocalDT

### IFD2410 / IFD2415



\* Can be connected via the PS2020 power supply unit (24 V / 2.5 A)

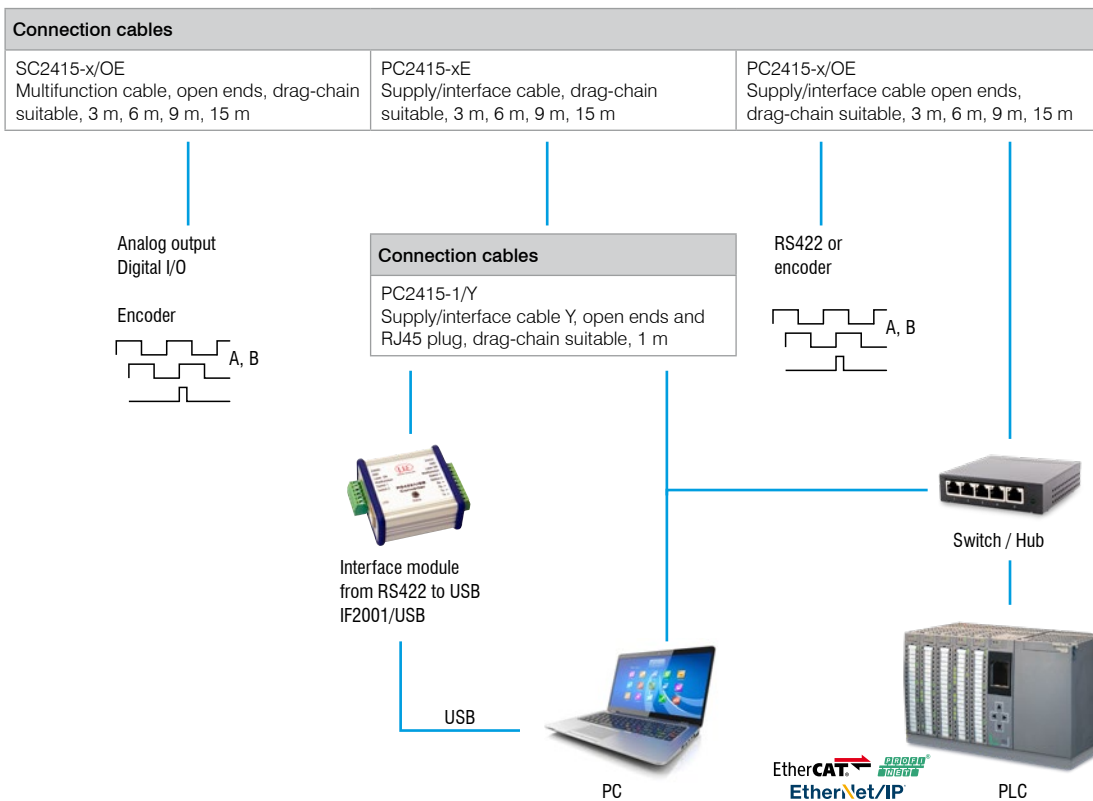

### IFC2411 / IFC2416 IFC2412 / IFC2417



\* Can be connected via the PS2020 power supply unit (24 V / 2.5 A)

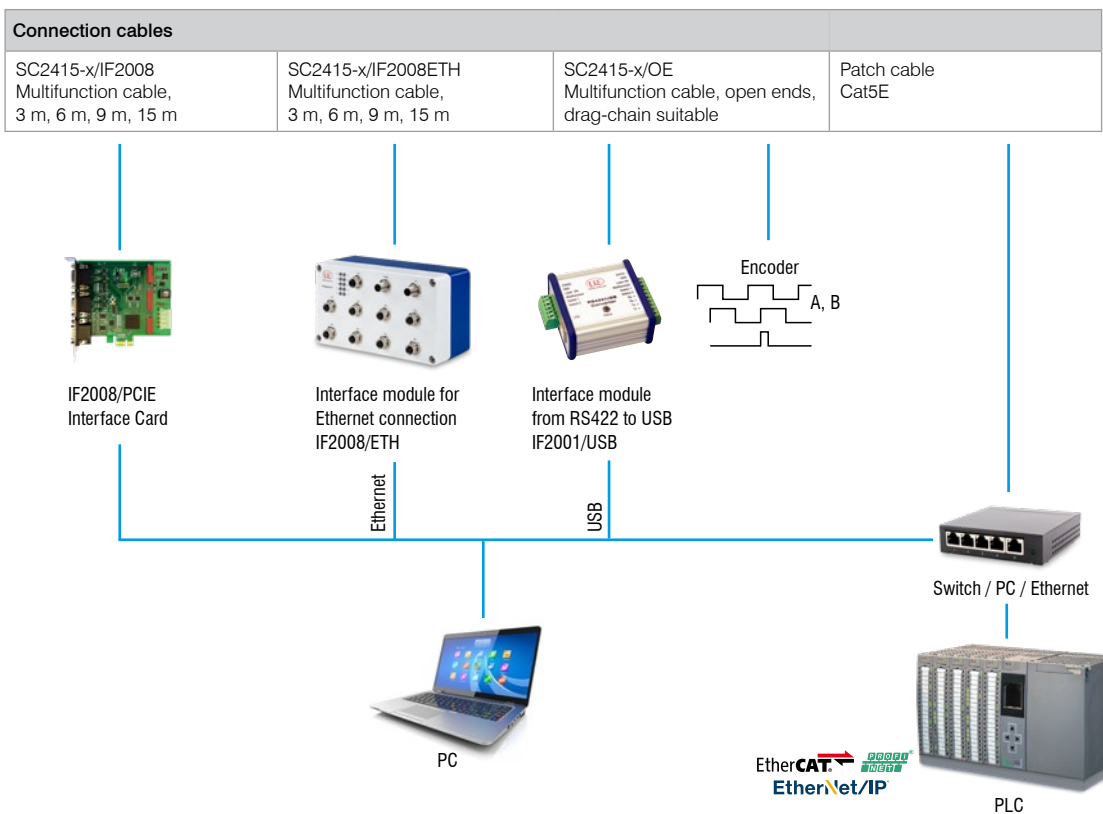

# Accessories

## Interface modules

Module	IFD2410/IFD2415	IFC2411/12	IFC2416/17	IFC242x	IFC246x
<b>IF2001/USB</b> Single-channel RS422/USB converter cable	✓	✓	✓	✓	✓
<b>IF2004/USB</b> RS422/USB converter to convert up to 4 digital signals to USB	⊘	✓	✓	✓	✓
<b>IF2008/ETH</b> Interface module for Ethernet connection for up to 8 sensors	⊘	✓	✓	✓	✓
<b>IF2008PCIE</b> Interface card for multiple sensor signals; analog and digital interfaces	⊘	✓	✓	✓	✓
<b>IF2035/PNET</b> Interface module for Industrial Ethernet connection (PROFINET)	⊘	⊘	⊘	✓	✓
<b>IF2035/ENETIP</b> Interface module for Industrial Ethernet connection (EtherNet/IP)	⊘	⊘	⊘	✓	✓

### IF2001/USB converter RS422 to USB

The RS422/USB converter converts the digital signals of a confocal controller into a USB data packet. The sensor and the converter are connected via the RS422 interface of the converter. Data output is via the USB interface. The converter also passes through additional signals and functions such as laser on/off, switch signals and function output. The connected controllers and the converter can be programmed through software.

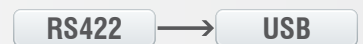
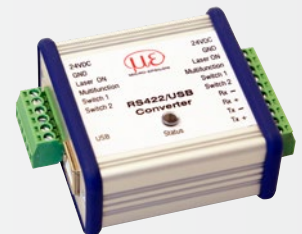

#### Characteristics

- Robust aluminum housing
- Easy sensor connection via screw terminals (plug and play)
- Conversion from RS422 to USB
- Supports baud rates from 9.6 kBaud to 12 MBaud

### IF2004/USB: 4-channel converter from RS422 to USB

The RS422/USB converter is used for transforming digital signals of up to four confocal controllers into USB data signals. The converter has four trigger inputs and a trigger output for connecting additional converters. Data is output via a USB interface. The connected controllers and the converter can be programmed through software. The COM interfaces can be used individually and can be switched.

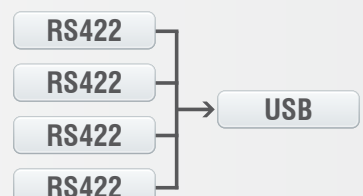

#### Characteristics

- 4x digital signals via RS422
- 4x trigger inputs, 1x trigger output
- Synchronous data acquisition
- Data output via USB

## IF2008/ETH

### Interface module for Ethernet connection with up to 8 sensors

The IF2008/ETH integrates up to eight sensors and/or encoders with an RS422 interface into an Ethernet network. Four programmable switching in-/outputs (TTL and HTL logic) are available.

Ten indicator LEDs directly on the module show both the channel and the device status. In addition, acquisition and output of data via Ethernet is performed at high speeds up to 200 kHz. Parameter setting of the interface module can be easily done via the web interface.



## IF2008PCle/IF2008E

### Interface card for synchronous data acquisition

Absolute synchronous data acquisition is a decisive factor for the deflection or straightness measurement using several controllers. The IF2008PCle interface card is designed for installation in PCs and enables the synchronous acquisition of four digital sensor signals and two encoders. The data is stored in a FIFO memory in order to enable resource-saving processing in blocks in the PC. The IF2008E expansion board also enables the acquisition of two digital controller signals, two analog controller signals and eight I/O signals.

#### Characteristics

- IF2008PCle - Basic printed circuit board: 4 digital signals and 2 encoders
- IF2008E - Expansion board: 2x digital signals, 2x analog signals and 8x I/O signals

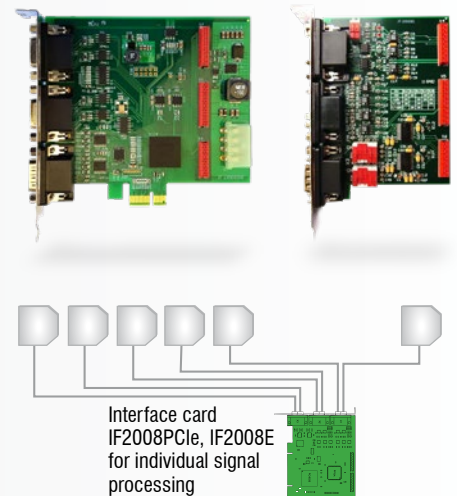

## IF2035

### Interface module for Industrial Ethernet connection

The IF2035 interface modules are designed for easy connection of Micro-Epsilon sensors to Ethernet-based fieldbuses. The IF2035 is compatible with sensors that output data via an RS422 or RS485 interface and supports the common Industrial Ethernet protocols EtherCAT, PROFINET and EtherNet/IP.

On the sensor side, these modules operate with up to 4 MBd and feature two network connections for different network topologies. In addition, the IF2035-EtherCAT offers a 4-fold oversampling function that enables faster measurements than the bus cycle would otherwise allow, if required. Installation in control cabinets is via a DIN rail.



## Sensors and Systems from Micro-Epsilon



Sensors and systems for displacement, distance and position



Sensors and measurement devices for non-contact temperature measurement



Measuring and inspection systems for metal strips, plastics and rubber



Optical micrometers and fiber optics, measuring and test amplifiers



Color recognition sensors, LED analyzers and inline color spectrometers

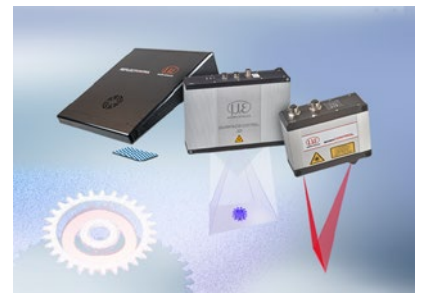

3D measurement technology for dimensional testing and surface inspection