



More Precision

capa**NCDT** // Capacitive sensors for displacement, distance & gap



Cylindrical sensors in very compact design (socket)

capaNCDT CSE



Model		CSE01-CAm1,4	CSE025-CAm1,4	CSE05	CSE1	CSE1.25	CSE2	CSE3
Measuring range	Reduced	0.05 mm	0.125 mm	0.25 mm	0.5 mm	0.625 mm	1 mm	1.5 mm
	Nominal	0.1 mm	0.25 mm	0.5 mm	1 mm	1.25 mm	2 mm	3 mm
	Extended	0.15 mm	0.5 mm	1 mm	2 mm	2.05 mm	4 mm	6 mm
Resolution ^[1]	Static	0.03 nm	0.075 nm	0.15 nm	0.3 nm	0.375 nm	0.6 nm	0.9 nm
	Dynamic	2 nm	5 nm	10 nm	20 nm	25 nm	40 nm	60 nm
Linearity ^[2]		< ±0.3 μm	< ±0.375 μm	< ±0.25 μm	< ±2 μm	< ±1.25 μm	< ±2 μm	< ±3 μm
Replaceability ^[3]		< ±0.5 % FSO	< ±0.5 % FSO	< ±0.2 % FSO	< ±0.2 % FSO	< ±0.2 % FSO	< ±0.2 % FSO	< ±0.2 % FSO
Temperature stability		-0.025 μm/K	-0.025 μm/K	-0.02 μm/K	-0.02 μm/K	-0.12 μm/K	-0.16 μm/K	-0.18 μm/K
Recommended target size (flat) ^[4]		Ø 3 mm	Ø 4 mm	Ø 6 mm	Ø 8 mm	Ø 10 mm	Ø 14 mm	Ø 20 mm
Active measuring area		Ø 1.8 mm	Ø 2.9 mm	Ø 3.9 mm	Ø 5.7 mm	Ø 6.5 mm	Ø 8 mm	Ø 9 mm
Connection ^[5]		integrated cable with connector (type B); standard length 1.4 m		Plug connection via triaxial socket (type C)		Plug connection via triaxial socket (type B)		
Mounting		Circumferential clamping						
Temperature range	Storage	-50 ... 200 °C						
	Operation	-50 ... 200 °C						
Shock (DIN EN 60068-2-27)		20 g / 5 ms in XY axis, 1000 shocks each			30g / 5 ms in XY axis, 1000 shocks each			
Vibration (DIN EN 60068-2-6)		10 g / 58 ... 2000 Hz in XY axis, 10 cycles each			20 g / 58 ... 2000 Hz in XY axis, 10 cycles each			
Protection class (DIN EN 60529)		IP40						
Material		NiFe (magn.)				1.4404 (non-magn.)		
Weight		approx. 26 g (incl. cable)	approx. 27 g (incl. cable)	approx. 2 g	approx. 3.5 g	approx. 8.2 g	approx. 20 g	approx. 50 g
Recommended mounting position ^[6]		2.5 mm	1.2 mm	3 mm	3 mm	3.5 mm	3.5 mm	4.5 mm
Compatibility		Compatible with all capacitive controllers from Micro-Epsilon Sensors can be replaced as required without recalibration (see replacement accuracy)						

^[1] RMS noise referred to the end of the measuring range and to the nominal measuring range using the standard cable CCm (1.4 m); valid for operation with the DT6530: static 2 Hz, dynamic 8.5 kHz

^[2] Typical linearity to be added to the controller linearity; valid for standard cable adjustment CCm (1.4 m)

^[3] FSO = Full Scale Output | The value corresponds to the slope error that occurs when a sensor is replaced without recalibration

^[4] In relation to the nominal measuring range

^[5] For suitable sensor cables, please refer to Connections

^[6] From the sensor front face (measuring surface), opposite to the measuring direction

Mounting of the cylindrical CSE sensors

CSE-type cylindrical sensors can be installed either protruding (with the sensor extending beyond the mounting bracket) or flush with the mounting bracket. However, when installing flush with the surface, a clearance must be taken into account. The sensor is mounted either by point clamping using a plastic set screw or by circumferential clamping using a collet. When using circumferential clamps, please note that the surrounding material may cause heat buildup. The technical specifications always refer to circumferential clamping at the recommended mounting position.

Recommended mounting of CSE sensors

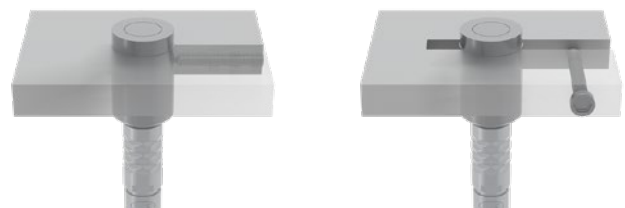

With set screw

With circumferential clamping

Dimensions

capaNCDT CSE

CSE01-CAm1,4

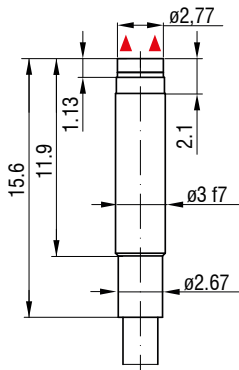

CSE025-CAm1,4

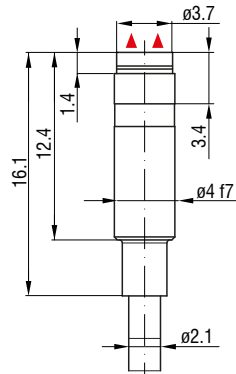

CSE05

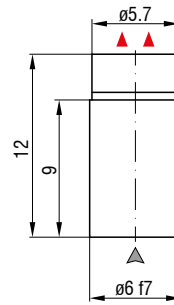

CSE1

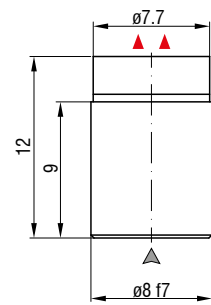

CSE1,25

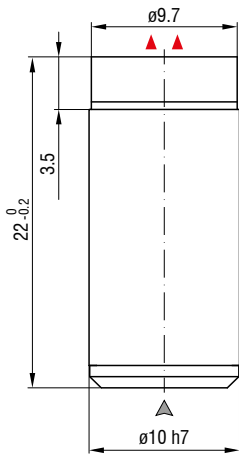

CSE2

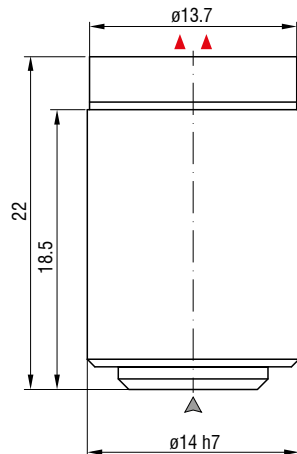

CSE3

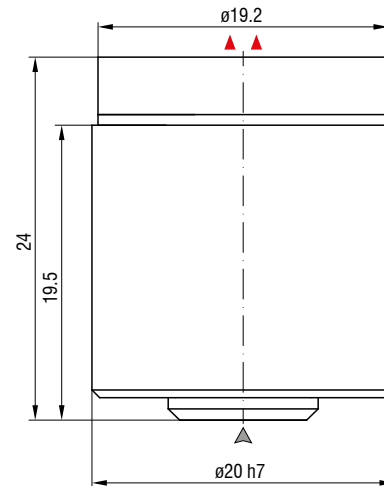

▲ ▲ Measurement direction

▲ Connector side

(dimensions in mm, not to scale)

Dimensions of the connectors

capaNCDT

All sensors can be combined with all controllers and sensor cables. To connect the sensors, you simply need to use the correct type of connector. Micro-Epsilon will select the right sensor cable with the appropriate connectors for you during the quotation and ordering process. The following dimensional drawings are intended to help you make an initial selection.

- The sensor connection varies depending on the sensor type. Depending on the model, the cable is either permanently integrated into the sensor or connected via an external sensor cable. Depending on the design and size, different connector types and sizes are used, which must be taken into account when selecting sensor cables. For more information on this, please refer to the technical specifications for the sensors under "Connection".
- The sensor is always connected to the controller using a type B connector.

You can find an overview of all connection and combination options on pages 52 - 53.

Type B connector

- On each sensor with an integrated cable or on one end of a sensor cable (except CSE/HT)
- For plug-in sensors with measuring ranges of ≥ 1 mm

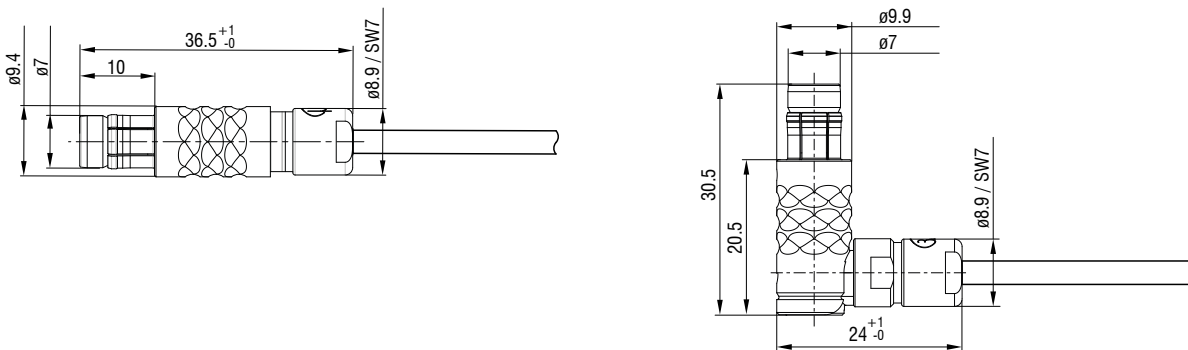

Cable with connector type C

- On one end of a sensor cable
- For all plug-in sensors with measuring ranges of ≤ 1 mm

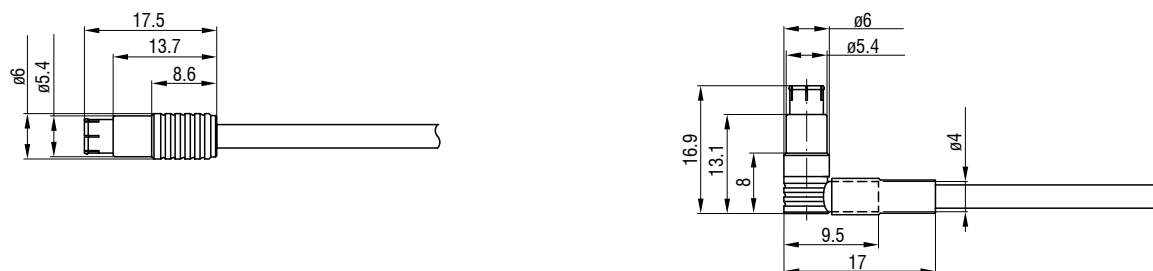

Cable with connector type E

- On one end of a sensor cable
- For all CSF flat sensors

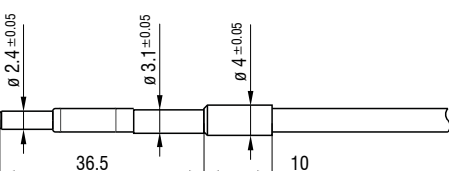

Connections and combinations

capaNCDT

Controller



DT6100



DT6200



DT6500

Sensor cable



Type: CCg

Robust triaxial cable for industrial applications
 Cable diameter: 3.1 mm (± 0.1 mm)
 Minimum bending radius: static approx. 10 mm /
 dynamic approx. 30 mm
 Temperature resistance: -20 ... +85 °C (permanent) /
 -20 ... +100 °C (limited to 10,000 h)
 Standard length: 2 m (optional lengths see p. 41)

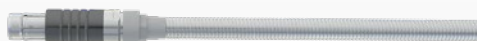

Type CCg/PT

Crush-resistant triaxial cable with protective metal tubing
 Cable diameter: 6 mm (± 0.15 mm)
 Minimum bending radius: static approx. 20 mm /
 dynamic approx. 30 mm
 Temperature resistance: -20 °C ... +85 °C (permanent) /
 -20 ... +100 °C (limited to 10,000 h)
 Standard length: 2 m (optional lengths see p. 41)

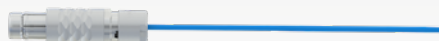

Type CCm

Low-outgassing triaxial cable for UHV and cleanroom
 Cable diameter: 2.1 mm (± 0.1 mm)
 Minimum bending radius: static approx. 7 mm /
 dynamic approx. 25 mm
 Temperature resistance: up to -100 ... 200 °C
 Standard length: 1.4 m (optional lengths see p. 41)



Type CCo

Low-outgassing triaxial cable for high temperatures
 Cable diameter: 3.1 mm (± 0.1 mm)
 Minimum bending radius: static approx. 10 mm /
 dynamic approx. 30 mm
 Temperature resistance: -20 ... +200 °C
 Standard length: 2 m (optional lengths see p. 41)

Sensors with integrated cable use the cable types CCM and CCg

Type CCM

Low-outgassing triaxial cable for UHV and cleanroom
 Cable diameter: 2.1 mm (± 0.1 mm)
 Minimum bending radius: static approx. 15 mm /
 dynamic approx. 30 mm
 Temperature resistance: up to 200 °C
 Standard length: 1.4 m (optional lengths see p. 41)

Type CCg

Robust triaxial cable for industrial applications
 Cable diameter: 3.1 mm (± 0.1 mm)
 Minimum bending radius: static approx. 10 mm /
 dynamic approx. 30 mm
 Temperature resistance: -20 °C ... +85 °C (permanent) /
 -20 ... +100 °C (limited to 10,000 h)
 Standard length: 2 m (optional lengths see p. 41)

Plug connector



Type B connector



Type B / 90 connector



Type B / IP connector



Type C connector



Type C / 90 connector



Type E connector

Sensors with socket



CS-x, CSE and CSE/Mx models
with a measuring range from 1 mm

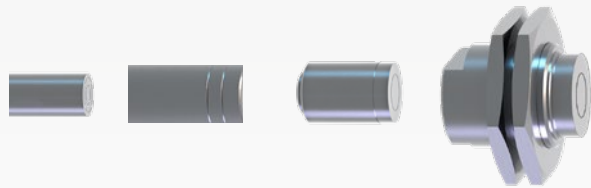

CS, CS-x, CSE and CSE/Mx models
with measuring range up to 1 mm



CSF flat sensors with socket

Sensors with integrated cable

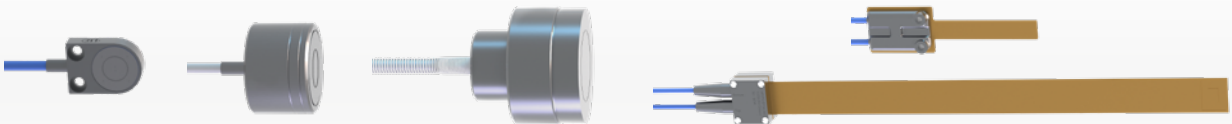

Technical details

capaNCDT

Minimum diameter of the measuring object

The relative size of the target has effects on the linearity deviation. Ideally, the object being measured should be at least as large as the "Recommended target size" specified in the technical data, or at least as large as the sensor's diameter. In this case, the sensor's full measuring range can be used without the need for additional calibration. Measuring objects smaller than the sensor diameter require a special calibration. The smaller the size (ratio measurement electrode and measuring object), the lower the accuracy.

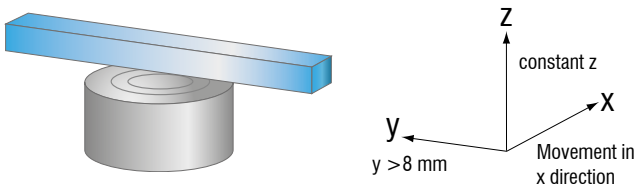
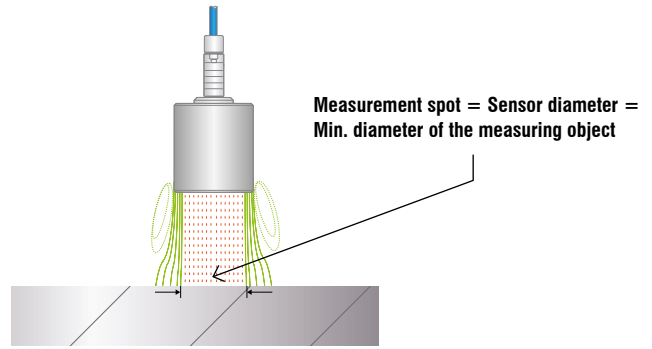

Measurement on narrow targets

The width of the object being measured affects the capacitive measurement signal. Simulations using a CS05 sensor (8 mm diameter) as an example show that even narrow objects can be measured reliably, provided they are sufficiently large and correctly positioned.

At a distance of 0.25 mm (mid of measuring range), even a centrally positioned object 5 mm wide produces a stable measurement signal. The larger the distance between the sensor and the measuring object, the larger the required minimum width.

The results show that the electric field does not extend beyond the entire diameter of the sensor. This makes it possible to take precise measurements even on narrow objects.

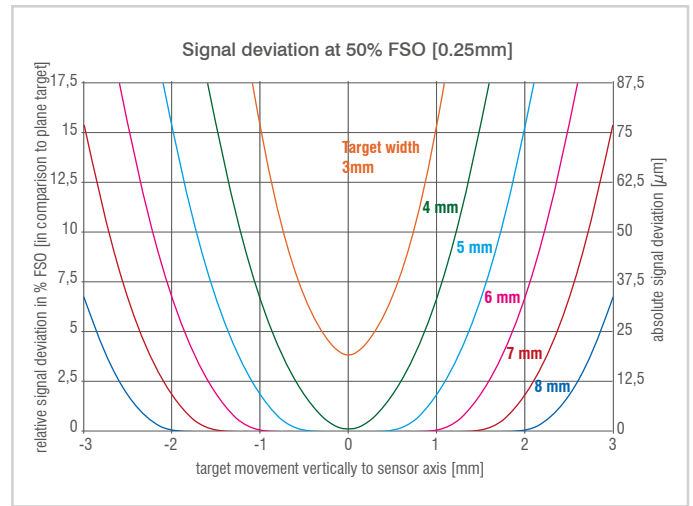

Conductivity of the measuring object

In order to achieve a linear output signal across the complete measuring range, certain requirements for the target or the counter electrode must be complied with. The impedance in the ideal plate capacitor can be shown in the equivalent circuit diagram by a capacitor and a resistor connected in parallel. For measurement against metals, the ohm part can be disregarded; the impedance is only determined by the capacitive part. Conversely, only the ohm part is considered for measurements against insulators.

In between, there is the large range of semiconductors. Most semiconductors can be measured very well as electrical conductors. The requirement is that the capacitive part of the total impedance is still significantly larger (>10x) than the ohmic part. This is almost always the case for silicon wafers irrespective of the endowment. Nevertheless, semiconductors with poor conductivity (e.g. GaAs) can also be measured as conductors under certain circumstances.

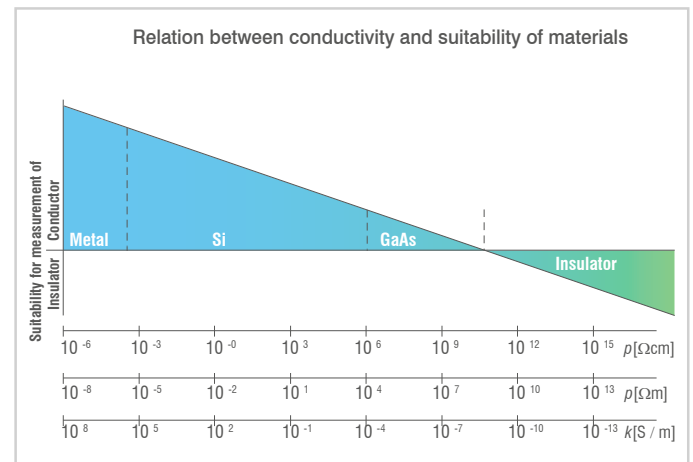

However, various adjustments are required for this, e.g. reduction of the operating frequency or a temporary, partial increase of the conductivity.

Minimum diameter of round measuring objects:

When measuring distances on curved surfaces such as when measuring wave patterns on rollers, measurement errors may occur. This is caused by the altered field line distribution and an enlarged effective measurement spot, which changes the measured capacitance. In practice, this results in a virtual zero point for the sensor, meaning that the measurement value of $0 \mu\text{m}$ is no longer

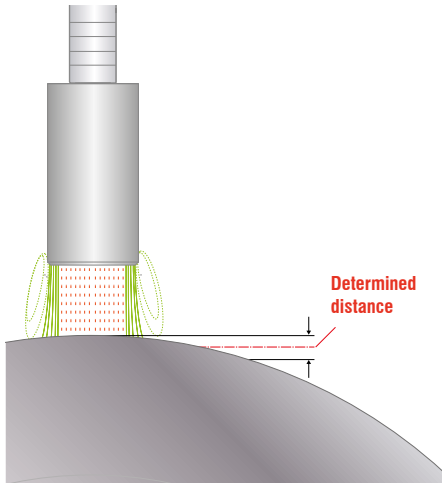

Example: For a sensor with a $200 \mu\text{m}$ measuring range and a roller with an outer diameter of 30 mm , an actual gap of $20 \mu\text{m}$ results in a measured value that is approximately 5 % higher. This corresponds to approx. $10 \mu\text{m}$ of the measuring range.

achieved. Since capacitive sensors integrate over their entire measuring surface, the virtual mean measurement plane lies behind the actual generatrix of the cylindrical target object. As this effect is predictable, corresponding correction curves can be stored in the controller.

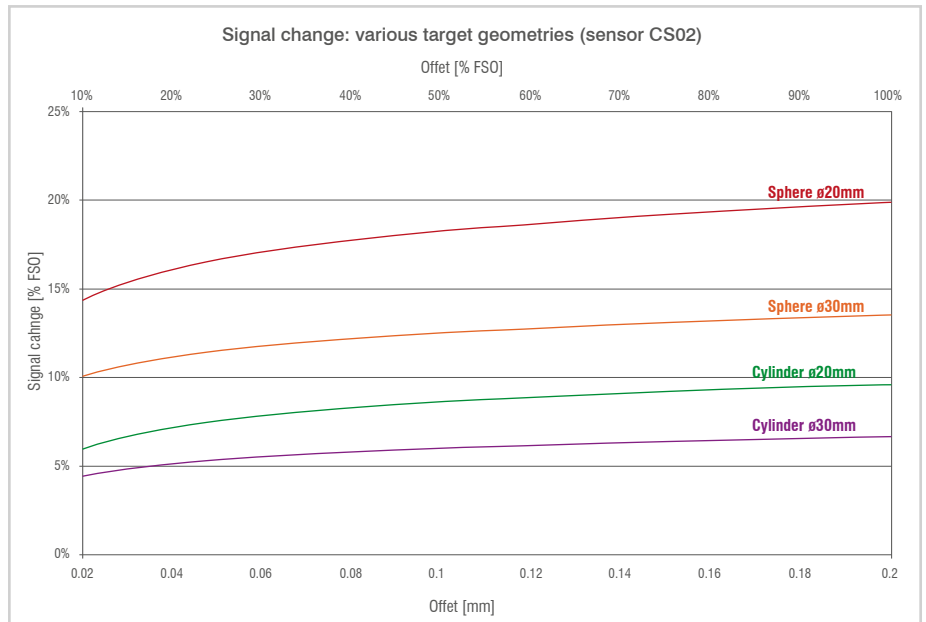

Inclination:

If the capacitive sensor or the measuring object is tilted, an error is likely to occur, as the geometric conditions of the field relative to the object being measured change. In fact, the average distance of the sensor remains constant; however, the edge areas move closer or further away from the target. The following figure illustrates this effect using the CS02 sensor as an example, with a maximum tilt angle of

1° at various sensor distances. At a 10 % offset along the sensor axis, contact between the sensor housing and the measuring object occurs at 0.38° ; at a 20 % offset, contact occurs at 0.76° . The simulation can be performed for all sensors and installation conditions; tilt angles around a decentralized tilt point can also be calculated.

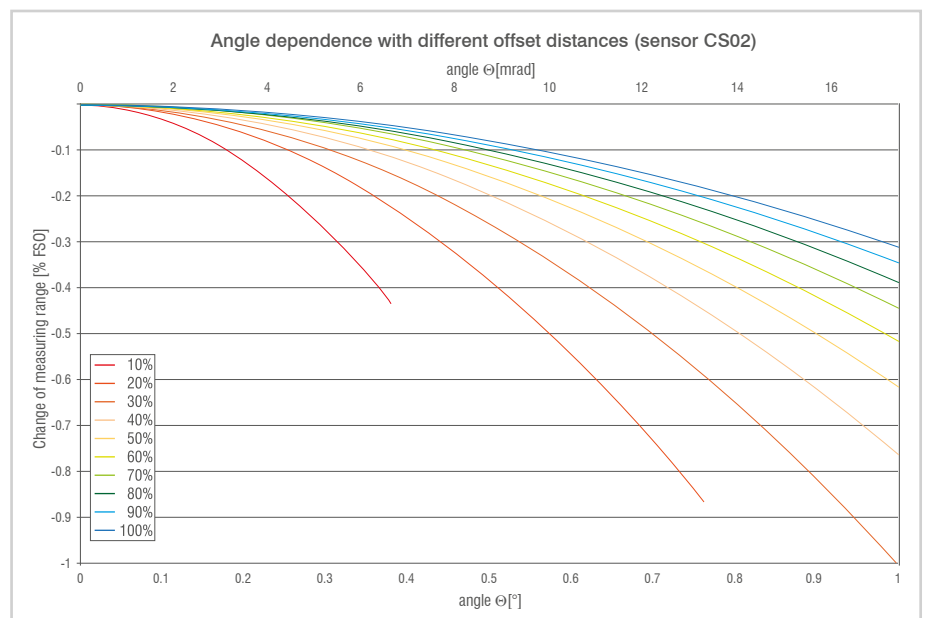
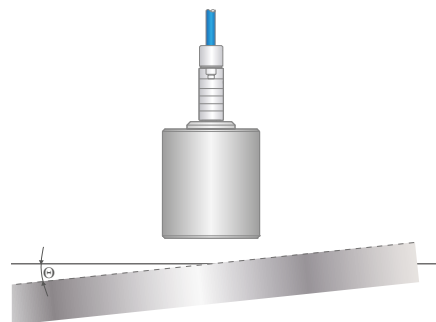

Sensors and Systems from Micro-Epsilon



Sensors and systems for displacement, distance and position



Sensors and measurement devices for non-contact temperature measurement

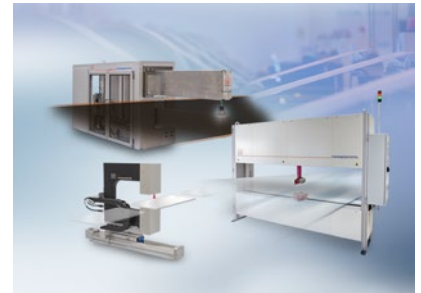

Measuring and inspection systems for metal strips, plastics and rubber



Optical micrometers and fiber optics, measuring and test amplifiers



Color recognition sensors, LED analyzers and inline color spectrometers

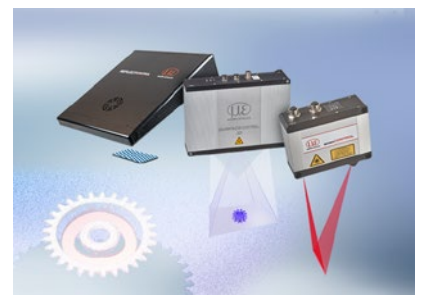

3D measurement technology for dimensional testing and surface inspection