



More Precision







optoNCDT ILR2250-100 // Laser distance sensor for industrial applications



High-performance laser distance sensor for industrial applications

optoNCDT ILR2250-100



-  Large measuring range up to 100 m (150 m with reflector)
-  Ideal for OEM serial integration
-  Extremely stable measurement
-  Highest signal stability on numerous surfaces
-  Compact & lightweight design
-  Now with IO-Link
- INTER FACE** Analog / USB
RS422 / PROFINET / EtherNet/IP

With the optoNCDT ILR2250-100, Micro-Epsilon presents a new powerful laser distance sensor. The sensor is designed for operation with or without reflector film, which is used depending on the distance and ambient conditions. The sensor measures large distances up to 100 m without contact and provides best results even on challenging (dark, structured or weakly reflecting) surfaces. The measuring range can be extended up to 150 m by attaching a reflector film to the measuring object.

Thanks to the integrated AUTO measurement mode, precise and reliable measurements can be made even on dark, partially reflecting and distant targets. A simple and fast alignment of the sensor is made possible by the integrated mounting plate with 4 threaded pins.

The ILR2250-100 laser distance sensors provide reliable results even under harsh conditions. They are protected against dust and splashes of water thanks to the robust design in an IP65 certified die-cast aluminum housing. Compact size combined with low weight opens up new fields of application particularly in factory and plant automation, as well as in drone applications for distance measurement from the air.

NEW: ILR2250-100-IO with IO-Link

The ILR2250-100-IO model is equipped with an IO-Link interface. The IO-Link communication standard simplifies data communication while reducing the commissioning time of the sensor.

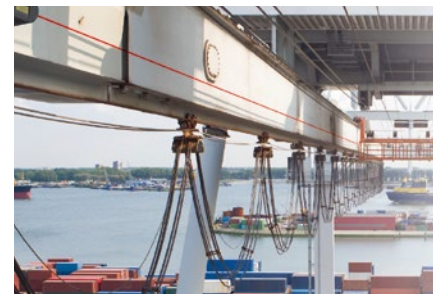

Position measurement on gantry cranes

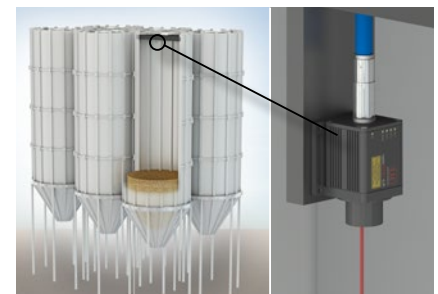

Filling level measurement in silos



Acquisition of coil diameters

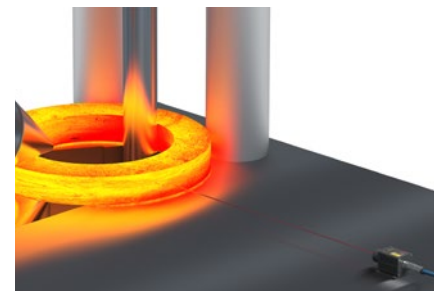

Diameter measurement of rings during rolling

Model	ILR2250-100	ILR2250-100-IO
Article number	7112015	7112016
Measuring range ¹⁾	black 6 %	0.05 ... 30 m
	gray 40 %	0.05 ... 70 m
	white 80 %	0.05 ... 100 m
	Reflector film ²⁾	35 ... 150 m
Measuring rate	20 Hz	
Resolution	0.1 mm	
Linearity	< ±0.5 mm ³⁾	
Repeatability ⁴⁾	< 300 µm	
Temperature compensation	-10 ... +50 °C	
Light source	Semiconductor laser < 1 mW, 655 nm (red)	
Typ. service life	50,000 h	
Laser safety class	Class 2 according to DIN EN 60825-1: 2015-07	
Permissible ambient light	50,000 lx	
Supply voltage	10 ... 30 VDC	
Power consumption	< 1.5 W (24 V)	
Signal input	Trigger	-
Digital interface	RS422 / USB / PROFINET / EtherNet/IP ⁵⁾	IO-Link 1.1; process data, parameter set up and diagnostics
Analog output	4 ... 20 mA (16 bit, freely scalable within the measuring range)	-
Switching output	Q1 / Q2 / Q3 (configurable)	Q1 / Q2 / Q3 (configurable) included in IO-Link process data
Connection	Supply/signal: 12-pin M16 screw/plug connection (see accessories for connection cable)	Supply/signal: 5-pin M12 screw/plug connection (adapter cable included in delivery)
Mounting	Screwing and adjustment on sensor base plate	
Temperature range	Storage	-25 ... +70 °C (non-condensing)
	Operation	-10 ... +50 °C (non-condensing)
Shock (DIN EN 60068-2-29)	15 g / 6 ms in 3 axes, in 3 directions, 1000 shocks each	
Vibration (DIN EN 60068-2-6)	15 g / 10 ... 500 Hz in 3 axes, 10 cycles each	
Protection class (DIN EN 60529)	IP65	
Material	Aluminum housing	
Weight	approx. 300 g	
Control and display elements	5x LEDs for power, signal strength and switching outputs	
Features	4 measurement-specific operating modes via sensorTOOL	4 measurement-specific operating modes via IO-Link

The specified data apply for a consistent room temperature of 20 °C, sensor is continuously in operation. Measured on white, diffuse reflecting surface (reference ceramic)

¹⁾ Depends on the reflectivity of the target, ambient light interference and atmospheric conditions

²⁾ ILR-RF210 reflector film 210 x 297 mm; art. 7966058

³⁾ Measured in the range of 0.05 ... 20 m; statistical spread 1σ; < ±1 mm at 2σ

⁴⁾ Measurement frequency of 20 Hz, moving average 10

⁵⁾ Connection via interface module (IF2001/USB bzw. IF2004/USB; IF2030/PNET; IF2030/ENETIP)

Oval spot diameter ILR2250-100

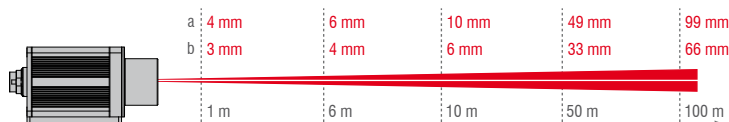

The ILR2250 sensor works with a semiconductor laser at a wavelength of 655 nm (visible/red). Laser power is < 1 mW. The sensors fall within laser class 2. Devices of this laser class require no special safety precautions.

EtherNet/IP®



Analog

RS422



Dimensions

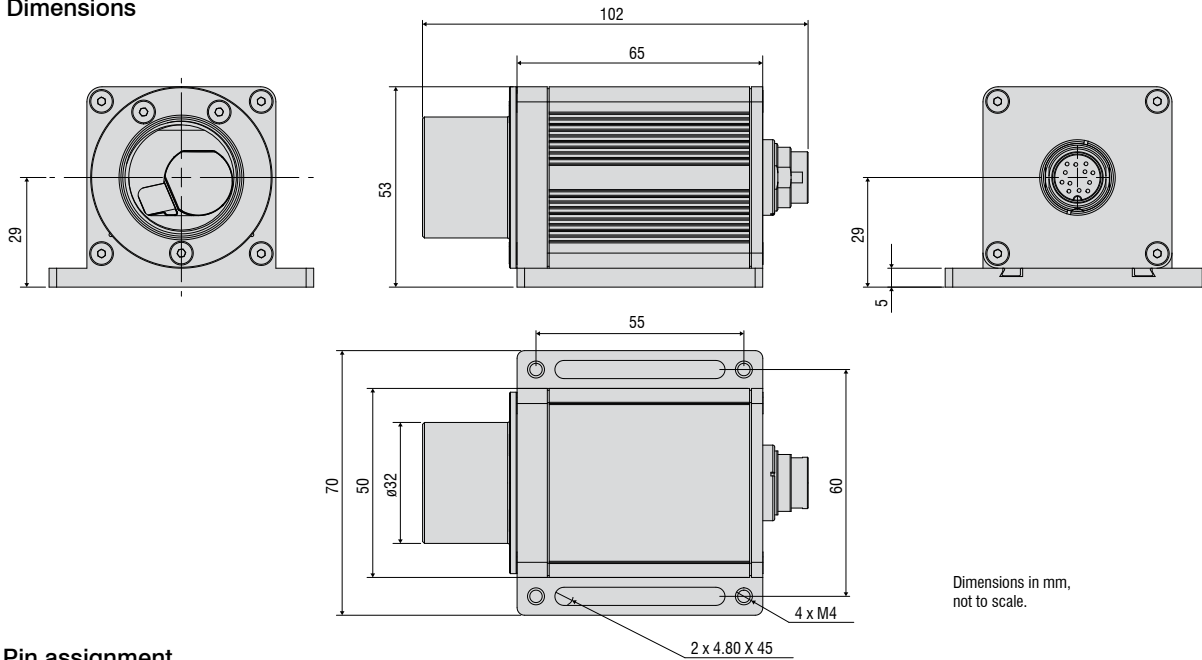

Dimensions in mm,
not to scale.

Pin assignment

ILR2250-100



12-pin cable connector
(ODU Mini-Snap, B series, size 2, coding 0)
View on solder side

Pin assignment for power supply and signal

Pin	Assignment	Color (cable: PC1100-x)
A	RS422 Rx+	White
B	RS422 Rx-	Brown
C	TRIG	Green
D	Analog output IOUT	Yellow
E	RS422 Tx+	Gray
F	RS422 Tx-	Pink
G	Supply voltage +UB	Red
H	Switching output 1	Black
J	Signal ground	Purple
K	Switching output 2	Gray/pink
L	Supply ground	Red/blue
M	Switching output 3	Blue

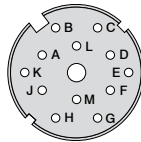

ILR2250-100-IO



Sensor side
12-pin cable connector (adapter cable for IO-Link)
View on solder pin side

Pin assignment for power supply and signal

Pin	Assignment	Color (cable: PC1100-0,3)
A	Not assigned	
B	Not assigned	
C	Not assigned	
D	Not assigned	
E	Not assigned	
F	Not assigned	
G	Supply voltage +UB	Brown
H	SIO Standard Input/Output	Black
J	Not assigned	
K	Not assigned	
L	Supply ground	Blue
M	Not assigned	

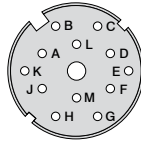

Adapter side
5-pin cable connector (adapter cable, class B port)
View on solder pin side

Pin assignment for power supply and signal

Pin	Assignment	Color (cable: PC1100-0,3)
1	Supply voltage +UB	Brown
2	Not assigned	White
3	Supply ground	Blue
4	SIO Standard Input/Output	Black
5	Not assigned	

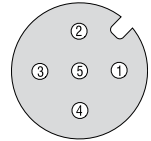

Adapter cable (included in delivery)



12-pin cable connector

5-pin connector
according to IO-Link standard



MICRO-EPSILON USA
8120 Brownleigh Dr. · Raleigh, NC 27617 / USA
Phone +1/919/787-9707 · Fax +1/919/787-9706
me-usa@micro-epsilon.com · www.micro-epsilon.com