



# More Precision

**boreCONTROL LAB** // System for non-contact bore hole inspection





#### Non-contact measurement of diameter in cylindrical geometries

boreCONTROL LAB is a system for non-contact measurement of diameter with  $\mu\text{m}$  precision and visual surface assessment. The tabletop device has been designed for applications in the test lab and in industrial environment. Typical applications are first article inspections or sampling inspection in production. The system is easy to use and delivers very precise information about the quality of a drilling or cavity in the diameter range from 4mm to 16mm.

#### System design

A granite base enables temperature stable and vibration-free measurements. The sensor consists of a quickly exchangeable sensor probe and a rotary drive. It is moved by a high precision linear stage in axial direction (z direction). Sensor probes for the diameters 4-10mm, 8-12.8mm and 10-16mm are available.

Measuring objects can be easily fixed and precisely positioned with a manual x-/y-table. The system is operated by an industrial tablet PC with intuitive software (PC and software are included).

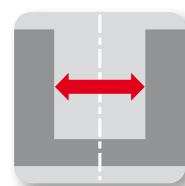

Diameter

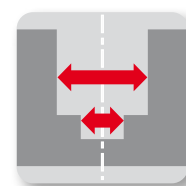

Steps

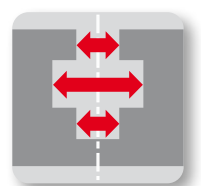

Cavity

### Measurement principle

The confocal-chromatic measurement principle is based on white light and offers following advantages:

- Non-contact measurement with a small light spot
- High resolution
- High dynamics (sampling rate up to 25kHz)
- Applicable for most diverse materials

### Features

- Non-contact measurement – also on sensitive surfaces
- Fast set-up and operation cycles
- High precision and detailed information about dimensions & surface quality
- Patented temperature compensation

### Applications

- Measurement of diameter
- Visual surface assessment
- R&D and quality assurance
- Measurement of precision parts in the sectors turning, milling, deep-drawing, injection moulding, etc.
- Applications in engineering, automotive, aircraft and medical industry



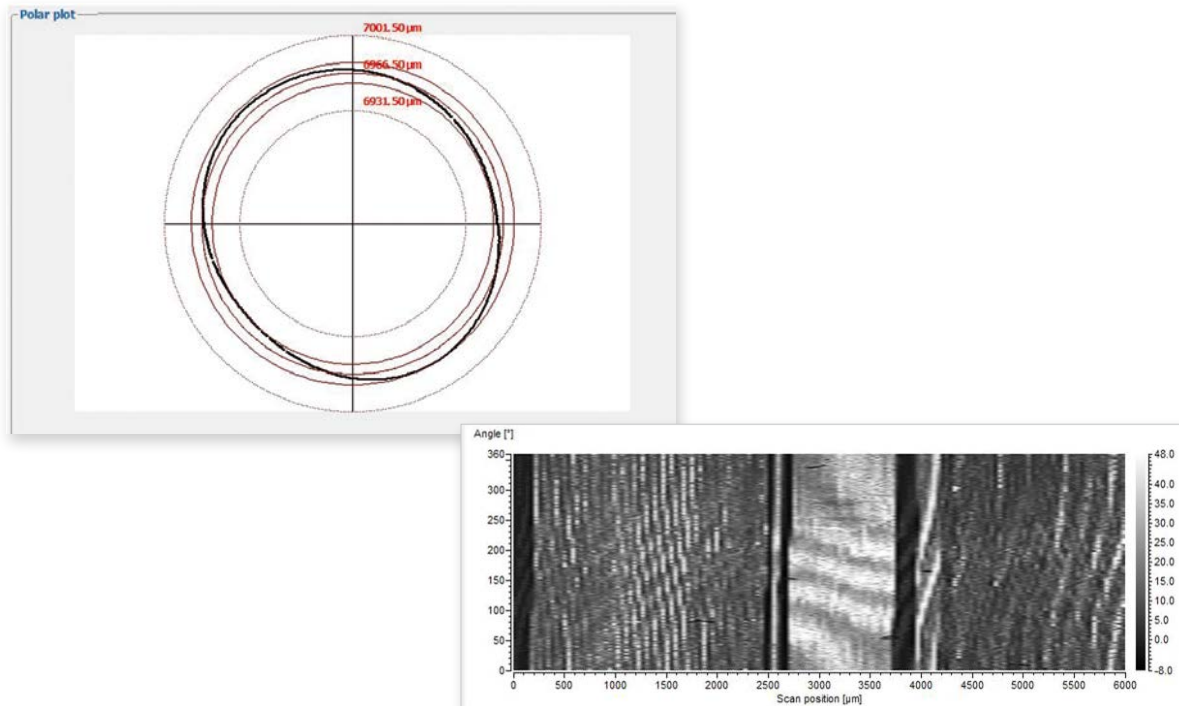

### Software

The included software provides following functions:

- Easy parameter setting for sensor & z-axis
- 2D plot of distance or intensity values for surface assessment
- Polar plot for visualization of diameter
- Table with measured values
- Export of log-file for further evaluation of measuring data
- Fast loading and saving of sensor settings

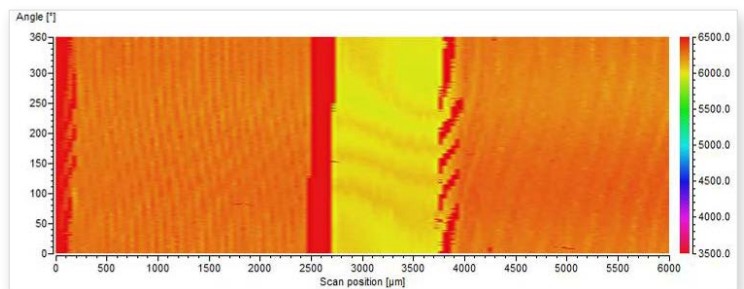

### Example:

Sampling rate: 10kHz, rotation frequency 10Hz → 1,000 points per rotation

Sensor scans the surface while rotating:

A displacement of 10mm and 500 rotations generates 500,000 measuring points.

Scan duration: 50 seconds

Time needed for target positioning and centring < 1 min

## Technical data

### Sensors

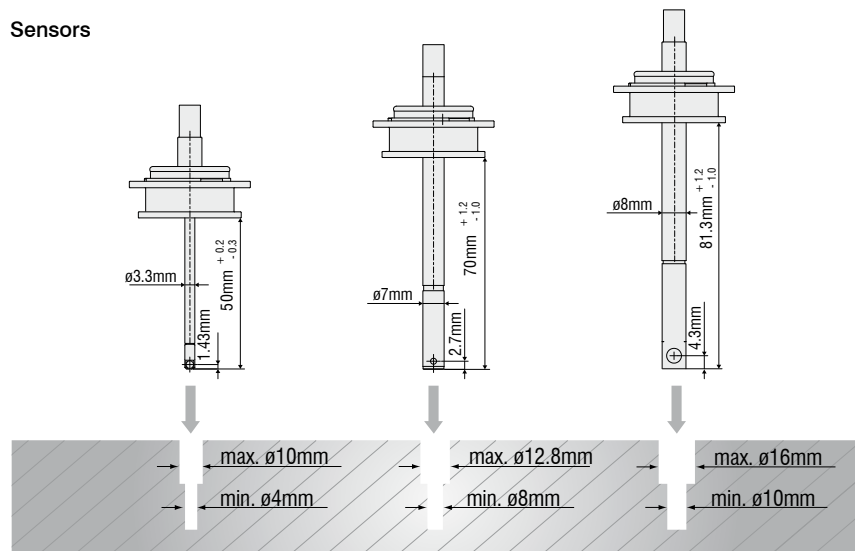

	<b>boreCONTROL LAB</b>
Dimensions (W x D x H)	700 x 600 x 1000mm
Weight	approx. 95kg
Supply voltage	100 ... 240V / 50...60Hz
Accuracy of linear drive for z-axis	$\pm 0.2\mu\text{m}$
Accuracy of rotation unit	$0.04^\circ$
Temperature range	$10^\circ\text{C} \dots 40^\circ\text{C}$
Rotation frequency	0.1Hz ... 10Hz
Included	Test device including industrial TabletPC & pre-installed Software

Sensor lance	BCS2412-4/10	BCS2412-8/12,8	BCS2413-10/16
Measuring range $\phi$	4 - 10mm	8 - 12.8mm	10 - 16mm
Sampling rate	max. 25kHz	max. 25kHz	max. 25kHz
Diameter measurement spot <sup>1)</sup>	approx. $40\mu\text{m}$	approx. $30\mu\text{m}$	approx. $30\mu\text{m}$
Dynamic repeatability <sup>2)</sup>	$\pm 1\mu\text{m}$	$\pm 1\mu\text{m}$	$\pm 1\mu\text{m}$
Linearity of $\phi$ <sup>2)</sup>	$\pm 5\mu\text{m}$	$\pm 5\mu\text{m}$	$\pm 5\mu\text{m}$

<sup>1)</sup> In the midrange

<sup>2)</sup> Specified accuracy to the following general conditions: min. sampling rate 1kHz; 60 rotations (repetitions) within 1 min; temperature drift:  $< 1\text{K/h}$ ; calibration ring (DIN 2250C), accuracy of center position  $\pm 50\mu\text{m}$ ; As the accuracy varies with different surfaces and their properties, we recommend you contact us directly. We will be pleased to check the technical feasibility of your measurement task.

## System Components

For customer specific applications the system components can be purchased individually. boreCONTROL consists of a rotation mechanics with a changeable sensor probe, a motor controller and a sensor controller. The rotary drive is operated by the motor controller.

The sensor controller serves for set-up and signal processing. Via the Ethernet-interface, boreCONTROL provides a data packet with distance, angle and intensity figures. For software development a SDK is included.

IFC2461(002) sensor controller	BCC2410 motor controller	BCM2410 rotating unit	BCS241x sensor lance
			
<p>Parameter set up and signal processing</p> <p>Data output via Ethernet</p>	<p>Controls the rotating unit</p> <p>Provides the sensor controller with angle information</p>	<p>Rotates the sensor lance in the interior wall</p>	<p>Detects the geometry of an interior wall</p> <p>Available for different diameters</p>

### Software:

boreCONTROL SDK

Software Development Kit for customer software integration (included in scope of supply)

### Accessories:

#### Model

C2400/PT-x

PC2410-x

SC2410-0,5

One-Click-Cleaner

#### Description

Optical-fibre cable (3m,5m,10m, customer-specific length up to 25m; optionally suitable for use with robots)

Power supply and signal cable (3m, 5m,10m, customer-specific length up to 25m, optionally suitable for use with robots)

Synchronisation cable (0.5m)

Cleans the optical connections

### Optional accessories:

#### Model

BCS2412-4/10 Dummy sensor

BCS2412-8/12,8 Dummy sensor

BCS2413-10/16 Dummy sensor

MA2400-45

Y adapter cable for encoder

PS2020

#### Description

For customer simulation of z movement during machine or robot setup

For customer simulation of z movement during machine or robot setup

For customer simulation of z movement during machine or robot setup

Mounting adapter for rotating unit

Cable for encoder signal input of customer-specific linear axis (z movement of sensor) into the IFC2461 controller

Power supply unit 24V / 2.5A

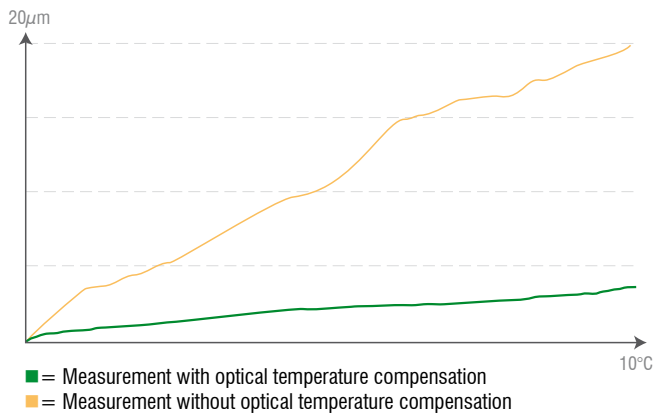

### Optical temperature compensation

Temperature fluctuations, which occur in everyday industrial operation can affect measurement results.

For highest precision and repeatability, Micro-Epsilon has developed a patented method to compensate temperature changes over the whole optical path in real-time with high dynamic.

## High performance sensors made by Micro-Epsilon



Sensors and systems for displacement and position



Sensors and measurement devices for non-contact temperature measurement



2D/3D profile sensors (laser scanner)



Optical micrometers, fibre optic sensors and fibre optics



Colour recognition sensors, LED analyzers and colour online spectrometer



Measurement and inspection systems



MICRO-EPSILON Headquarters  
Koenigbacher Str. 15 · 94496 Ortenburg / Germany  
Tel. +49 (0) 8542 / 168-0 · Fax +49 (0) 8542 / 168-90  
info@micro-epsilon.com · [www.micro-epsilon.com](http://www.micro-epsilon.com)

MICRO-EPSILON UK Ltd.  
No.1 Shorelines Building · Shore Road · Birkenhead · CH41 1AU  
Phone +44 (0) 151 355 6070 · Fax +44 (0) 151 355 6075  
info@micro-epsilon.co.uk · [www.micro-epsilon.co.uk](http://www.micro-epsilon.co.uk)