



More Precision

thermoMETER // Non-contact IR temperature sensors





thermoMETER CX

OEM temperature sensor with integrated controller

- Measuring range from -30°C to 900°C
- High resolution model available (CX-SF15-C8 with 0.025°C)
- Easy two-wire installation
- Optional USB interface and software for programming
- Large power supply range: 5-30VDC
- Optical resolution from 15:1, 22:1
- Simultaneous two-wire output and digital communication
- Alarm output (0-30V / 500mA)
- Connection dimension 1.5" for easy replacement of present sensors

Optical specifications thermoMETER CX

□ = smallest spot size (mm)

Standard Focus										
SF15	15:1	7	8	13	20	27	33	40	47	53
SF22	22:1	7	7	9	14	18	23	27	32	36
	distance (mm)	0	100	200	300	400	500	600	700	800
Close Focus										
CF15	15:1	7	5	0.8	5	11	16	21	27	32
CF22	22:1	7	4	0.6	4	8	12	16	20	24
	distance (mm)	0	5	10	15	20	25	30	35	40

Model	CX-SF15-C8	CX-SF22-C8
Optical resolution	15:1	22:1
Temperature range ¹	-20°C to 150°C	-30°C to 900°C
Spectral range	8 to 14μm	
System accuracy ²	±1% or ±1°C	±1% or ±1.4°C
Repeatability ²	±0.3% or ±0.3°C	±0.5% or ±0.7°C
Temperature resolution	0.025°C ³	0.1°C
Response time	150ms (95%)	
Emissivity/gain ¹	0.100 to 1.100	
Transmissivity ¹	0.100 to 1.100	
Signal processing ¹	peak hold, valley hold, average; extended hold function with threshold and hysteresis	
Certificate of calibration	optional	
Outputs/analog	4 to 20mA	
Output/alarms	0 to 30V / 500mA (open collector)	
Outputs/digital (optional)	USB	
Output/impedance	max. 1000Ω (depends on power supply)	
Cable length	8m	
Power supply	5 to 30VDC	
Protection class	IP65 (NEMA-4)	
Ambient temperature	-20°C to 75°C	
Storage temperature	-40°C to 85°C	
Relative humidity	10 to 95%, non condensing	
Vibration	IEC 68-2-6: 3 G, 11 to 200Hz, any axis	
Shock	IEC 68-2-27: 50 G, 11ms, any axis	
Weight	350g	

¹ adjustable via software

² at ambient temperature 23 ±5°C; whichever is greater; with object temperature ≥ 0°C;

³ with object temperature <100°C; time constant from >0.2s

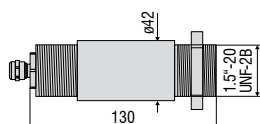

Product identification

CX -	SF15-	C8
		Cable length [8m]
		Focus [SF / CF]
thermoMETER CX		

Accessories page 54-55

- Ancillary CF lens
- Protective window
- Air purge collar
- USB kit

CSLaser

sensor

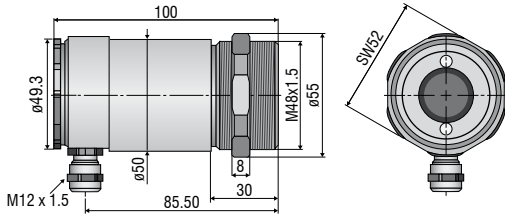

CS

sensor with integrated controller

ancillary CF lens (optional)

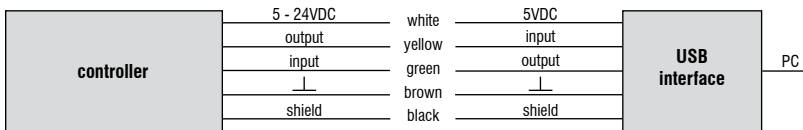
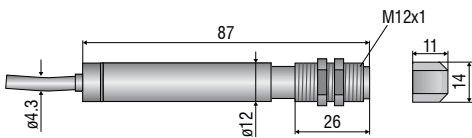

CSmicro / CSmicro 2W

ancillary CF lens (optional)

sensor

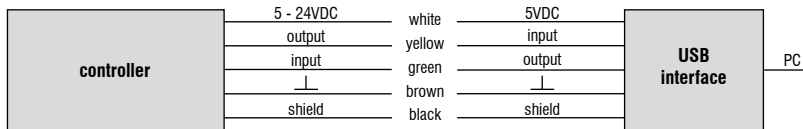
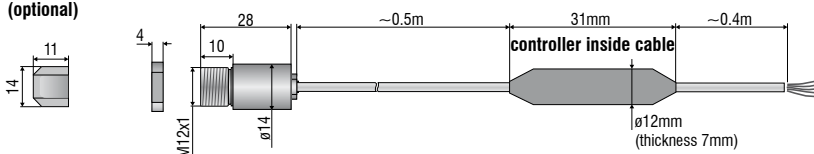

CX

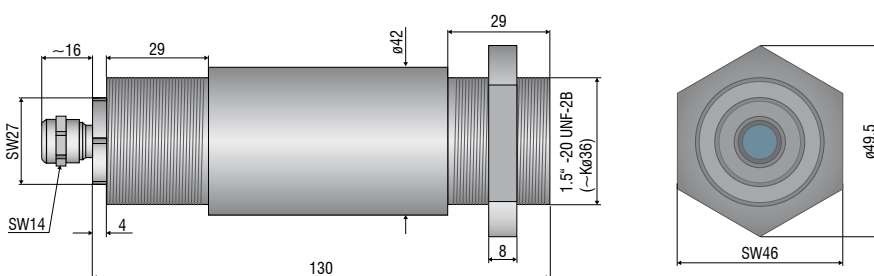

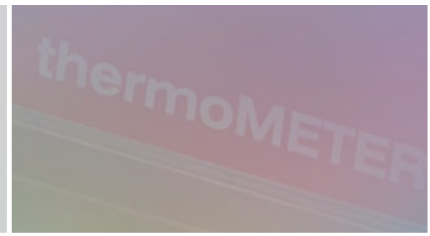

Mechanical accessories CS / CSmicro / CSmicro 2W

Art. No.	Model	Description
2970279	TM-FB-CS	Mounting bracket, fixed
2970280	TM-AB-CS	Mounting bracket, adjustable
2970281	TM-MB-CS	Mounting bolts with M12x1 thread
2970282	TM-MG-CS	Mounting fork, adjustable in 2 axes, with M12x1 fastening
2970283	TM-AP-CS	Air purge collar for 10:1 sensors
2970284	TM-APL-CS	Air purge collar, laminar
2970285	TM-APLCF-CS	Air purge collar, laminar, with integrated ancillary CF lens
2970286	TM-RAM-CS	Right angle mirror for measurements 90° to the sensor axis
2970287	TM-USBK-CS	USB kit: USB programming adapter, software CompactConnect

Optical accessories CS / CSmicro / CSmicro 2W

2970277	TM-CF-CS	Ancillary CF lens for CS models
2970278	TM-PW-CS	Protective window for CS models

Calibration CS / CSmicro / CSmicro 2W

2970288	TM-CERT-CS	Certificate of calibration
---------	------------	----------------------------

Mechanical accessories CX

Art. No.	Model	Description
2970307	TM-AP-CX	Air purge collar, aluminum (anodized)
2970321	TM-FB-CX	Mounting bracket, adjustable in one axis, stainless steel
2970322	TM-AB-CX	Mounting bracket, adjustable, in 2 axes, stainless steel
2970311	TM-USBK-CX	USB kit: USB programming adapter, software CompactConnect

Optical accessories CX

2970302	TM-CF-CX	Ancillary CF lens for CX models
2970303	TM-PW-CX	Protective window for CX models

Calibration CX

2970323	TM-CERT-CX	Certificate of calibration
---------	------------	----------------------------

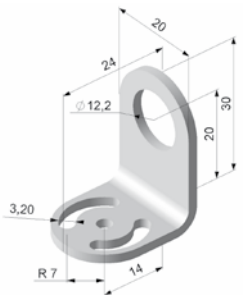

TM-FB-CS Mounting bracket, fixed

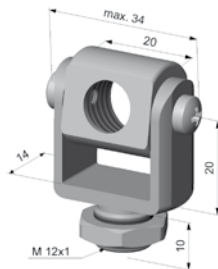

TM-MG-CS Mounting fork with M12x1 thread, adjustable in two axes

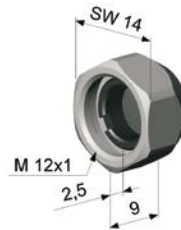

TM-CF-CS Ancillary CF lens (only for LT models)

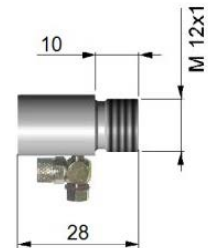

TM-AP-CS Air purge collar for 10:1 sensors

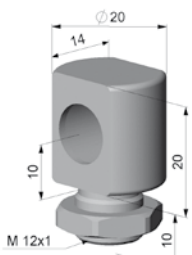

TM-MB-CS Mounting bolts with M12x1 thread adjustable in one axis

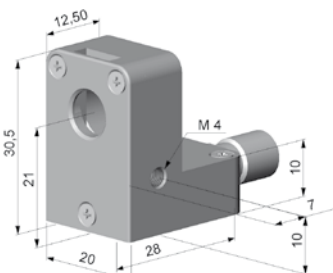

TM-APL-CS Air purge collar, laminar

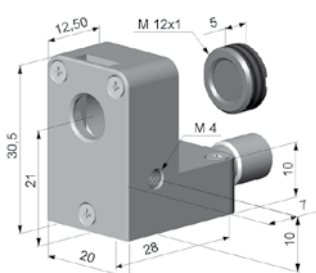

TM-APLCF-CS Air purge collar, laminar with integrated ancillary CF lens



TM-APL-CS Air purge collar, laminar
TM-MG-CS mounting fork

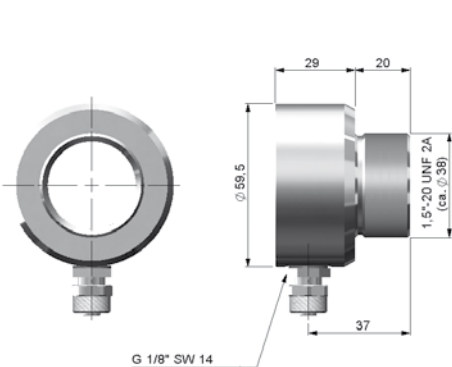

TM-AP-CX Air purge collar for CX sensors

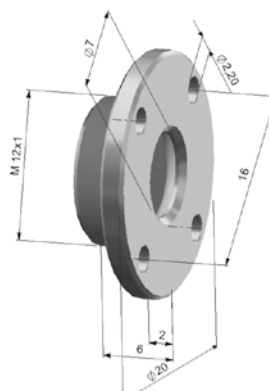

TM-CF-CX Ancillary CF lens, TM-PW-CX protective window



TM-RAM-CS Right angle mirror

Further IR temperature measurement devices from Micro-Epsilon



thermoIMAGER TIM
Compact USB thermal imaging cameras
for precise thermography



thermoMETER CTVideo/CSVideo
IR temperature sensors with crosshair laser
sighting and video output



thermoMETER Handheld
Innovative handheld pyrometer with laser
sighting for inspection and maintenance