



More Precision

thermoMETER // Non-contact infrared temperature sensors





thermoMETER CTLaserGLASS

Non-contact infrared temperature sensor for the glass industry

- Measuring range from 100°C to 1650°C
- Accurate glass temperature measurements on flat glass lines and container glass machines, e.g. with bulb manufacturing, car glass finishing and the production of solar panels and glass bottles
- Double laser marks the exact spot size from 1mm
- Optical systems 70:1 and 45:1 with selectable focus
- Compact sensor design
- Up to 85°C ambient temperature without cooling, laser switch-off at 50°C
- Cooling and protection accessories for harsh environmental conditions
- Selectable and scalable analog output, optional digital interfaces

Optical specifications thermoMETER CTLaserGLASS

□ = smallest spot size / focal point (mm)

Standard Focus

SF45L	45:1	20	20.9	21.8	22.6	23.5	24.4	25.3	26.1	27	32.9	38.8	50.5	62.3	74		
SF70H	70:1	20	19.6	19.3	18.9	18.5	18.1	17.8	17.4	17	21.6	26.3	35.5	44.8	54		
	distance in mm	0	150	300	450	600	750	900	1050	1200	1350	1500	1800	2100	2400		

Close Focus

CF1L	45:1	20	9.5	6.9	1.6	10.9	26.3	41.7	57.1	72.6	88	103.4	118.9	134.3	165.1	196	226.9
CF1H	70:1	20	9.1	6.4	1	10	25	40	55	70	85	100	115	130	160	190	220
CF2L	45:1	20	15.6	14.5	12.3	8.9	3.4	11.2	19	26.8	34.6	42.4	50.2	58	73.6	89.2	104.8
CF2H	70:1	20	15.3	14.1	11.7	8.1	2.2	9.6	17	24.4	31.8	39.2	46.6	54	68.8	83.6	98.4
CF3L	45:1	20	16.9	16.1	14.6	12.3	8.4	4.5	10.6	16.8	22.9	29	35.1	41.3	53.5	65.8	78
CF3H	70:1	20	16.6	15.7	14	11.5	7.2	2.9	8.6	14.3	20.1	25.8	31.5	37.3	48.7	60.1	71.6
CF4L	45:1	20	19.1	18.9	18.4	17.8	16.7	15.6	14.4	13.3	12.2	11.1	10	13.3	20	26.7	33.3
CF4H	70:1	20	18.8	18.5	17.9	17	15.5	14	12.5	11	9.5	8	6.5	9.4	15.3	21.2	27.1
	distance in mm	0	40	50	70	100	150	200	250	300	350	400	450	500	600	700	800

Model	CTLG-SF45L-C3	CTLGF-SF45H-C3	CTLG-SF70H-C3
Optical resolution	45:1		70:1
Temperature range ¹	100 to 1200°C	200 to 1650°C	250 to 1650°C
Spectral range	5.0µm		
System accuracy ²	±1% or ±1.5°C		
Repeatability ²	±0.5% or ±0.5°C		
Temperature resolution	0.1°C		
Response time (90% signal)	120ms	10ms	80ms
Emissivity/gain ¹	0.100 to 1.100		
Transmissivity/gain ¹	0.100 to 1.000		
Signal processing ¹	peak hold, valley hold, average; extended hold function with threshold and hysteresis		
Certificate of calibration	optional		
Outputs/analog	channel 1	0/4 to 20mA, 0 to 5/10V, thermocouple J, K	
	channel 2	sensor temperature (-20 to 180°C as 0 to 5V or 0 to 10V), alarm output	
Outputs/analog	optional	relays: 2 x 60VDC/42 VAC _{eff} ; 0.4A; electrically isolated	
Alarm output		open collector (24V / 50A)	
Outputs/digital	optional	USB, RS232, RS485, CAN, Profibus DP, Ethernet	
Output impedances	current output	mA max. 500Ω (with 5 to 36VDC)	
	voltage output	min. 100kΩ load impedance, thermocouple 20Ω	
Inputs		programmable functional inputs for external emissivity adjustment, ambient temperature compensation, trigger	
Cable length		3m (standard), 8m, 15m	
Power supply		8 to 36VDC; max. 160mA	
Laser		class II (635nm), 1mW, ON/OFF via controller or software	
Protection class		IP65 (NEMA-4)	
Ambient temperature		sensor: -20°C to 85°C (50°C if Laser ON); controller: 0°C to 85°C	
Storage temperature		sensor: -40°C to 85°C controller: -40°C to 85°C	
Relative humidity		10 to 95%, non-condensing	
Vibration	sensor	IEC 68-2-6: 3 G, 11 to 200Hz, any axis	
Shock	sensor	IEC 68-2-27: 50 G, 11ms, any axis	
Weight		sensor: 600g; controller: 420g	

¹ adjustable via programming keys or software

² ambient temperature: 23±5°C; whichever is greater

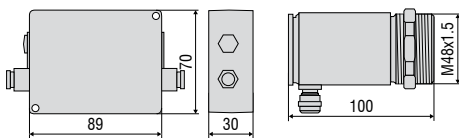

Product identification

CTLG -	SF45L-	C3
Cable length [3m (standard) / 8m / 15m]		
Focus [SF45L/ SF70H / CF1L/H / CF2L/H / CF3L/H / CF4L/H]		
thermoMETER CTLaserGLASS		

Accessories page 20 - 21

- Mounting bracket
- Air purge collar
- Rail mount adapter for controller
- Water cooled housing
- Interface kit
- Certificate of calibration



LASER LIGHT
DO NOT STARE INTO BEAM
CLASS 2 LASER
DIN EN 60825-1:2007
1mW / 630-650nm

CTLaser / CTLaserFAST / CTLaserGLASS / CTLaserM1/M2/M3/M5 / CTLaserCOMBUSTION

Controller

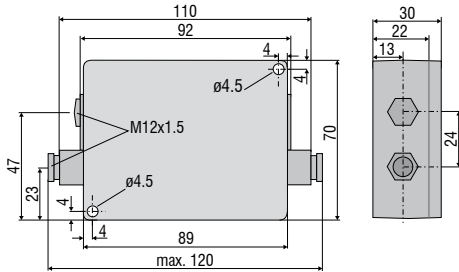

Sensor

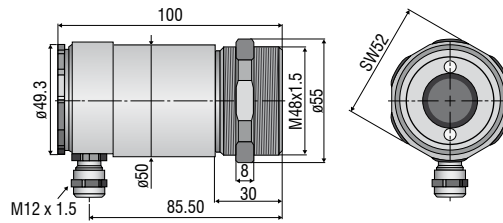

CTratioM1

Controller

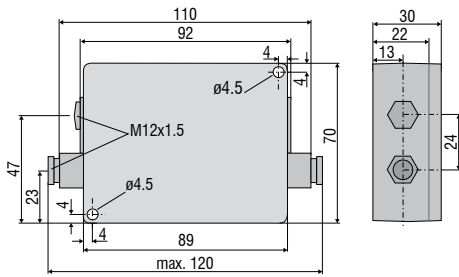

Sensor

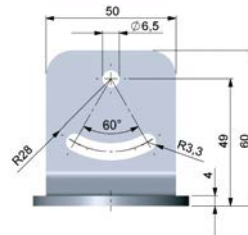
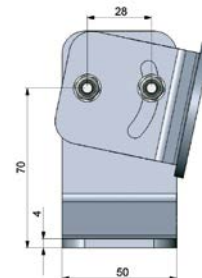
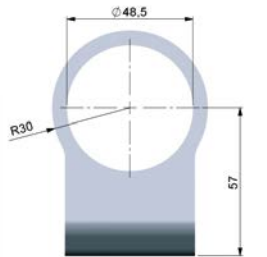
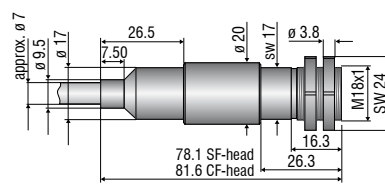

TM-FB-CTL Mounting bracket (fixed); included in CTL scope of supply

TM-AB-CTL Mounting bracket (adjustable)



TM-W-CTL Water cooled housing

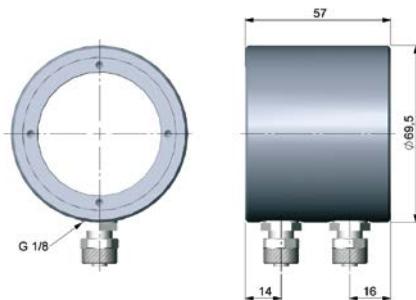

TM-AP-CTL Air purge collar

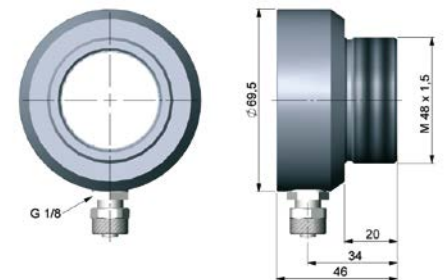

TM-W-CTL Water cooled housing and air purge collar TM-AP-CTL, mounted on adjustable mounting bracket TM-AB-CTL

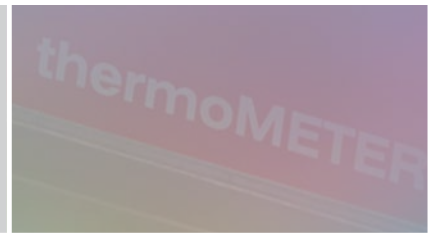

Mechanical accessories		
Art. No.	Model	
2970238	TM-AB-CTL	Mounting bracket, adjustable, stainless steel
2970239	TM-AP-CTL	Air purge collar, stainless steel
2970240	TM-W-CTL	Water cooled housing, stainless steel, for ambient temperatures up to 175°C
2970241	TM-RAIL-CTL	Rail mount adapter for CTLaser controller
2970242	TM-COV-CTL	Closed cover for controller
2970243	TM-MN-CTL	Mounting nut, stainless steel (spare)
2970244	TM-FB-CTL	Mounting bracket, fixed, stainless steel (spare)
2970298	TM-A20UN-CTL	Screw adapter M48x1.5 on 20UN-2A screw including mounting nut

High temperature accessories		
2970366	TM-J-CTL	Cooling jacket (length 228mm, ø89mm) (conversion kit TM-CONK-CTL is required)
2970374	TM-CONK-CTL	Conversion kit for CTL on axial cable exit, for integration in cooling jacket
2970368	TM-JAB-CTL	Adjustable mounting bracket for cooling jacket
2970369	TM-MF-CTL	Mounting flange M48x1.5 for TM-PF-CTL
2970370	TM-AST300-CTL	Reflection protection tube M48x1.5, 300mm length
2970371	TM-PA-CTL	Pipe adapter M48x1.5
2970372	TM-RM-CTL	Furnace wall mount accessory for CTL (TM-MF-CTL, TM-AST300-CTL and TM-PA-CTL)
2970412	TM-PF-CTL	Pipe flange M48x1.5 for directly mounting a CTL sensor
2970487	TM-CJA-CTL	Cooling Jacket Advanced - universal cooling jacket for CSLaser, CTLaser and CTVideo / CSVideo up to 315°C

Calibration		
2970253	TM-CERT-CTL	Certificate of calibration
2970324	TM-HTCERT-CTL	Certificate of calibration for CTLaser M1-/M2-/M3-/M5-/G-sensors

Interfaces		
2970245	TM-USBK-CTL	USB interface, computer cable, CompactConnect software second cable gland for controller
2970246	TM-RS232K-CTL	RS232 interface, computer cable, CompactConnect software, second cable gland for controller
2970338	TM-RS485USBK-CTL	RS485-USB-adapter, incl. PC cable, CompactConnect software and CTmulti, second cable gland for use with interface board TM-RS485B-CTL
2970248	TM-RS485B-CTL	RS485 interface board incl. second cable gland
2970249	TM-CANK-CTL	CAN-Bus interface; protocol: CANopen Presets: module address20 (14H), 250kbaud, 0-60°C
2970250	TM-PFBDPK-CTL	Profibus-DPV1 interface with plug-in connection
2970251	TM-ETHNK-CTL	Ethernet-Kit: interface board, external Ethernet adapter, CompactConnect software, second cable gland
2970252	TM-RI-CTL	Relay interface: two electrically isolated relays, 60VDC/ 42VAC _{eff} 0.4A

Sensor cables and high temperature cables for CTLaser		
2970374	TM-CONK-CTL	Connector-Kit for cables with connector
4800254.003	TM-CB3C-CTL	Sensor cable with connector (3m)
4800254.003H	TM-CB3HC-CTL	High-temperature sensor cable (up to 180°C) with connector (3m)
4800254.008	TM-CB8C-CTL	Sensor cable with connector (8m)
4800254.008H	TM-CB8HC-CTL	High-temperature sensor cable (up to 180°C) with connector (8m)
4800254.015	TM-CB15C-CTL	Sensor cable with connector (15m)
4800254.015H	TM-CB15HC-CTL	High-temperature sensor cable (up to 180°C) with connector (15m)



TM-J-CTL Cooling jacket (length 228mm, ø 89mm) with adjustable mounting bracket TM-JAB-CTL; suitable for ambient temperatures up to 180°C

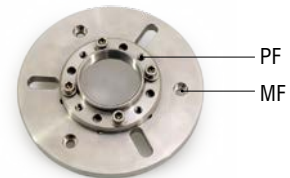

TM-PF-CTL and TM-MF-CTL mounting flange M48x1.5 for directly mounting a CTL sensor

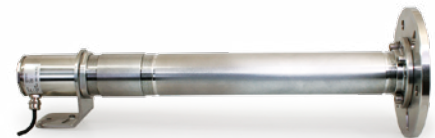

TM-RM-CTL Furnace wall mount accessory for CTLaser / CTratio: TM-MF-CTL, TM-PF-CTL, TM-AST300-CTL and TM-PA-CTL

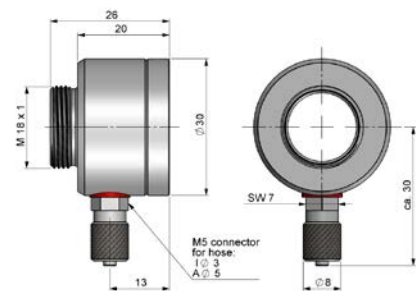

TM-AP-CTR Air purge collar

CTratio		
Art. No.	Model	
2970348	TM-FB-CTR	Mounting bracket, stainless steel, adjustable in one axis
2970395	TM-AP-CTR	Air purge collar, stainless steel
2970373	TM-RM-CTR	Furnace wall mount
2970351	TM-CERT-CTR	Certificate of calibration

Further IR temperature measurement devices from Micro-Epsilon



thermoIMAGER TIM
Compact USB thermal imaging cameras
for precise thermography



thermoMETER CTVideo/CSVideo
Infrared temperature sensors with crosshair
laser sighting and video output



thermoMETER Handheld
Innovative handheld pyrometer with laser
sighting for inspection and maintenance