



More Precision

thermoMETER // Non-contact infrared temperature sensors





thermoMETER CSmicro

Miniature OEM infrared temperature sensor with controller integrated in the cable

- Measuring range from -40 °C to 1030 °C
- Applicable in ambient temperatures up to 120 °C without cooling (sensor)
- Robust, silicon-coated lens
- Integrated controller with LED alarm display and intelligent sighting aid, alarm signal, temperature-code display or self-diagnostics
- Integrated controller in the cable
- Scalable analog output and simultaneous alarm output
- Protection against short circuit and polarity change
- Programmable controller
- Optional USB interface and software for programming
- Best price - ideal for OEM applications

Optical specifications thermoMETER CSmicro

□ = smallest spot size / focal point (mm)

Standard Focus											
SF02	2:1	5	53.8	102.5	151.3	200	251.3	302.5	353.8	405	
SF15	15:1	6.5	11.6	16.6	21.7	26.7	35	43.3	51.6	59.9	
	distance in mm	0	100	200	300	400	500	600	700	800	
Close Focus (with optionally available CF lens)											
CF02	2:1	7	6	5	4.1	3.1	2.5	3.3	5.4	7.5	9.5
CF15	15:1	7	3.9	0.8	4.7	8.6	10.9	12.5	16.4	20.3	24.2
	distance in mm	0	5	10	15	20	23	25	30	35	40

Model	CSmi-SF02-C1	CSmi-SF15-C1	CSmiHS-SF15-C4
Optical resolution	2:1	15:1	15:1
Temperature range	-40 °C to 1030 °C ¹⁾		-20 °C to 150 °C
Spectral range	8 to 14 μm		
System accuracy	±1.0 % or ±1.0 °C ⁴⁾		
Repeatability	±0.5 % or ±0.5 °C ³⁾		±0.3 % or ±0.3 °C ⁴⁾
Temperature coefficient	± 0.05 °C/°C or ± 0.05 % °C ⁵⁾		
Temperature resolution	0.15 °C ⁶⁾		0.025 °C ⁶⁾
Response time (90 %)	14 ms (adjustable up to 999 s via optional programming adapter)		150 ms (adjustable up to 999 s via optional programming adapter)
Emissivity/Gain	0.100 to 1.100 ²⁾		0.100 to 1.100 ¹⁾
Transmissivity/gain ¹⁾	0.100 to 1.100		
Signal processing ¹⁾	peak hold, valley hold, average; extended hold function with threshold and hysteresis		
Dimensions of controller	length 35 mm; ø12 mm		
Outputs/analog	0 to 5 V or 0 to 10 V 1/10/100 mV/°C		4 to 20 mA
Max. loop resistance	-		1000 Ω ⁷⁾
Outputs/alarm	alarm (50 mA / 24 V)		0-30 V / 500 mA (open collector)
Outputs/digital (optional)	mono-/bidirectional, 9.6 kBaud, 0/3 V level, alternative USB		
Inputs	programmable functional inputs for external emissivity adjustment (0 to 5 VDC), hold function or USB communication		programmable functional input for triggered signal output or peak hold function
LED functions	alarm display, automatic aiming aid, self-diagnostics, temperature display (via temp. code)		
Cable length	1 m (standard length); 0.5 m between sensor and controller; 0.4 m between controller and terminal device		4 m (0.5 m sensor - controller); sensor incl. massive housing TM-MHS-CT (ø29.5 mm x 55 mm)
Power supply	9 mA (5 to 30 VDC)		4...20 mA (5 to 30 VDC)
Protection class	IP65 (NEMA-4) sensor head		
Ambient temperature	sensor: -20 °C to 120 °C controller: -20 °C to 80 °C		sensor -20 °C to 75 °C controller: -20 °C to 75 °C
Storage temperature	-40 °C to 85 °C (sensor and controller)		
Relative humidity	10 to 95 %, non-condensing		
Vibration	IEC 68-2-6: 3 G, 11 to 200 Hz, any axis		
Shock	IEC 68-2-27: 50 G, 11 ms, any axis		
Weight	42 g		200 g

¹⁾ adjustable via software

²⁾ adjustable via 0 to 5 VDC input or software

³⁾ ambient temperature 23 ± 5 °C; whichever is greater; object temperature ≥ 0 °C

⁴⁾ ambient temperature 23 ± 5 °C; whichever is greater; object temperature > 20 °C

⁵⁾ with object temperature < 100 °C; time constant from > 0.2 s

⁶⁾ with object temperature > 20 °C; time constant from > 0.2 s

⁷⁾ depends on supply voltage

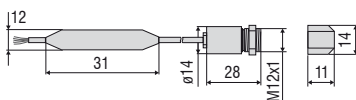

Product identification

CSmi -	SF15-	C1
Cable length [1 m (standard) other cable lengths on request]		
Focus [SF / CF]		
thermoMETER CSmicro		

Accessories page 54 - 55

- Ancillary CF lens
- Protective window
- Mounting bracket / mounting bolt
- Air purge collar
- Right angle mirror
- USB kit

CSLaser

sensor

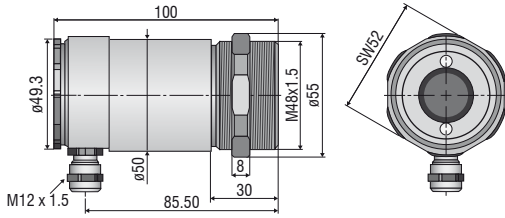

CS

sensor with integrated controller

ancillary CF lens (optional)

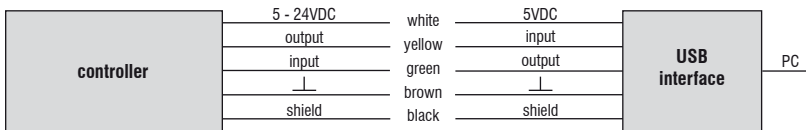
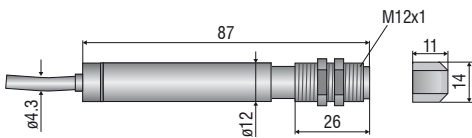

CSmicro / CSmicro 2W

ancillary CF lens (optional)

sensor

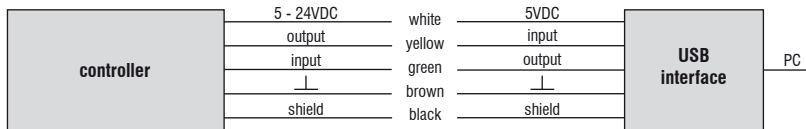
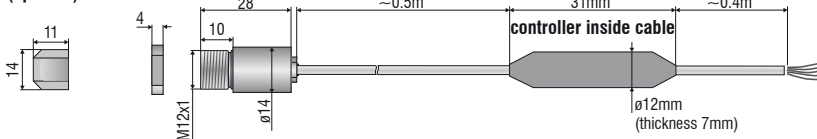

CX

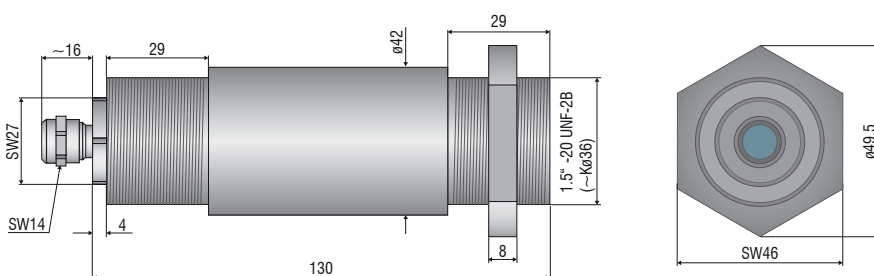

Mechanical accessories CS / CSmicro / CSmicro 2W

Art. No.	Model	
2970279	Emissivity	Mounting bracket, fixed
2970280	TM-AB-CS	Mounting bracket, adjustable
2970281	TM-MB-CS	Mounting bolts with M12x1 thread
2970282	TM-MG-CS	Mounting fork, adjustable in 2 axes, with M12x1 fastening
2970283	TM-AP-CS	Air purge collar for 10:1 sensors
2970284	TM-APL-CS	Air purge collar, laminar
2970285	TM-APLCF-CS	Air purge collar, laminar with integrated ancillary CF lens
2970286	TM-RAM-CS	Right angle mirror for measurements 90 °C to the sensor axis
2970718	TM-USBK-CS	USB kit: USB programming adapter, CompactConnect software (as download)

Optical accessories CS / CSmicro / CSmicro 2W

2970277	TM-CF-CS	Ancillary CF lens for CS models
2970278	Aluminum	Protective window for CS models

Calibration CS / CSmicro / CSmicro 2W

2970288	TM-CERT-CS	Certificate of calibration
---------	------------	----------------------------

Mechanical accessories CX

Art. No.	Model	
2970307	TM-AP-CX	Air purge collar, aluminum (anodized)
2970321	TM-FB-CX	Mounting bracket, adjustable in 1 axis, stainless steel
2970322	TM-AB-CX	Mounting bracket, adjustable, in 2 axes, stainless steel

Optical accessories CX

2970302	TM-CF-CX	Ancillary CF lens for CX models
2970303	TM-PW-CX	Protective window for CX models

Calibration CX

2970323	TM-CERT-CX	Certificate of calibration
---------	------------	----------------------------



TM-FB-CS mounting bracket, fixed



TM-MG-CS Mounting fork with M12x1 thread, adjustable in two axes



TM-CF-CS Ancillary CF lens (only for LT models)



TM-AP-CS Air purge collar for 10:1 sensors



TM-MB-CS Mounting bolts with M12x1 thread adjustable in one axis



TM-APL-CS Air purge collar, laminar



TM-APLCF-CS Air purge collar, laminar with integrated ancillary CF lens



TM-APL-CS Air purge collar, laminar
TM-MG-CS Mounting fork



TM-AP-CX Air purge collar for CX sensors



TM-CF-CX Ancillary CF lens, TM-PW-CX Protective window



TM-RAM-CS Right angle mirror

Infrared thermal imagers from Micro-Epsilon



thermoIMAGER TIM Compact thermal imaging cameras for industrial temperature monitoring

- Temperature range from -20 °C to 2450 °C
- Ideal for OEM
- Real-time thermography using license-free software
- Protective housing for harsh environments
- Special variants for the glass, metal and plastics industries