

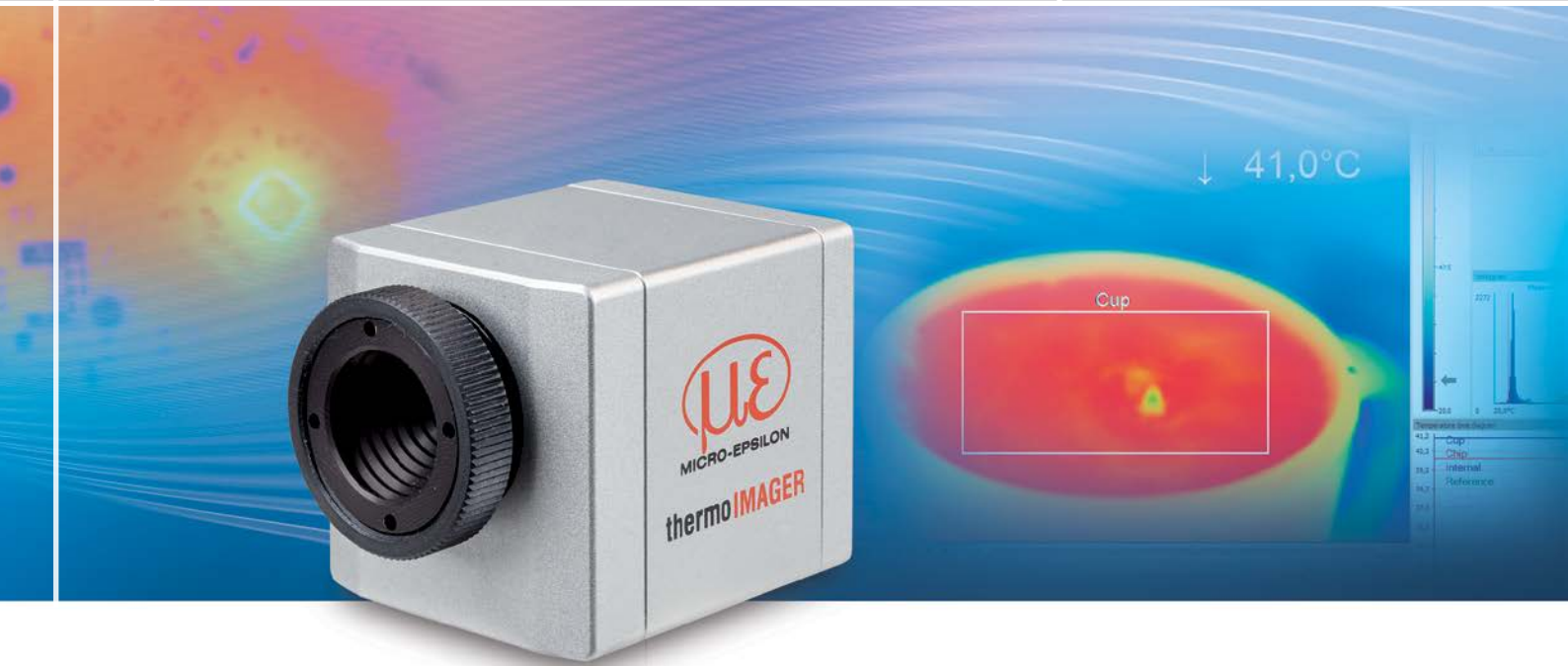

# More Precision

thermo**IMAGER** TIM // Compact thermal imaging cameras





### thermoIMAGER TIM 160S

Miniature industrial thermal imaging camera

- Measuring range from -20 °C to 900 °C (special model up to 1500 °C)
- Excellent thermal sensitivity (NEDT) of 0.08 K
- Exchangeable lenses 12° FOV, 30° FOV, 55° FOV or 80° FOV
- Real-time thermography with 120 Hz frame rate via USB 2.0 interface
- Power supply and data transfer via USB interface
- Extremely lightweight (195 g) and robust (IP67)
- Extremely compact dimensions (45 mm x 45 mm x 62 - 77 mm)
- Analog input and output, trigger interface
- TIMConnect software delivered with Software Developer Kit

### Software

- Display of the thermal image in real time (120 Hz) with recording function (video, snapshot)
- Complete set up of parameters and remote control of the camera
- Detailed analysis of fast, thermodynamic processes
- Output of analog temperature or alarm values via the process interface
- Digital communication via RS232 or DLL for software integration

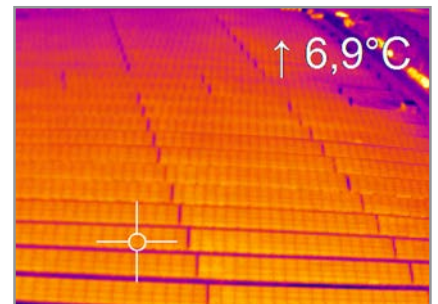

Surface measurements in industrial applications

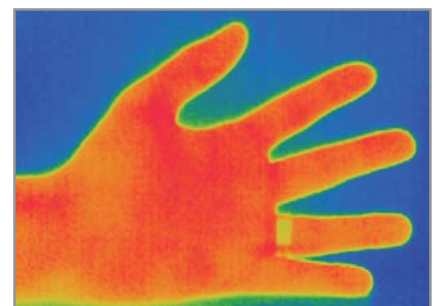

Suitable lenses for every measurement distance

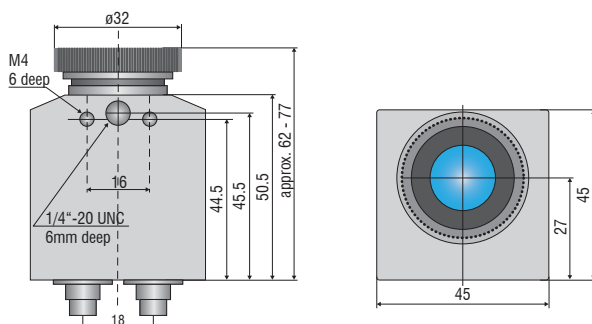

Model	TIM 160S
Optical resolution	160 x 120 pixels
Temperature ranges	-20 ... 100 °C, 0 ... 250 °C, (20) 150 ... 900 °C <sup>1)</sup> additional temperature range: 200 ... 1500 °C (optional)
Spectral range	8 to 14 μm
Frame rate	120 Hz
System accuracy	±2 °C or ±2 %, whichever is greater
Lenses	12° x 9° FOV / f = 13 mm or 30° x 23° FOV / f = 5 mm or 55° x 40° FOV / f = 3 mm or 80° x 54° FOV / f = 2 mm
Thermal sensitivity (NETD) <sup>2)</sup>	80 mK with 30° FOV 100 mK with 55° and 80° FOV 300 mK with 12° FOV
Detector	FPA, uncooled (17 μm x 17 μm)
Outputs/digital	USB 2.0 / optional interface USB to GigE (PoE)
Standard process interface (PIF)	0 - 10 V input, digital input (max. 24 V), 0 - 10 V output
Industry process interface (PIF)	2x 0 - 10 V inputs, digital input (max. 24 V), 3x 0/4 - 20 mA outputs, 3x relays (0 - 30 V/ 400 mA), fail-safe relay
Cable length	1 m (standard), 5 m, 10 m, 20 m 5 m and 10 m also available as high temperature USB cable (180 °C or 250 °C)
Power supply	USB powered
Tripod mount	1/4-20 UNC
Protection class	IP67
Ambient temperature	0 ... 50 °C
Storage temperature	-40 ... 70 °C
Relative humidity	20 to 80 %, non-condensing
Vibration	IEC 60068-2-6 (sinus-shaped) / IEC 60068-2-64 (broadband noise)
Shock	IEC 60068-2-27 (25 g and 50 g)
Housing (size)	45 mm x 45 mm x 62 - 77 mm (depending on lens and focus position)
Weight	195 g, incl. lens

<sup>1)</sup> For the range (20)150 up to 900 °C, the accuracy specification applies from 150 °C

<sup>2)</sup> Values apply with 40 Hz and 25 °C room temperature

## Scope of supply

### TIM 160S

- TIM process camera  
incl. a selectable lens
- Operating instructions
- USB cable 1 m
- Software for real-time processing  
and analyzing thermal images
- Tripod mount
- PIF cable 1 m
- Transport case
- Test certificate

## TIMConnect SOFTWARE FEATURES

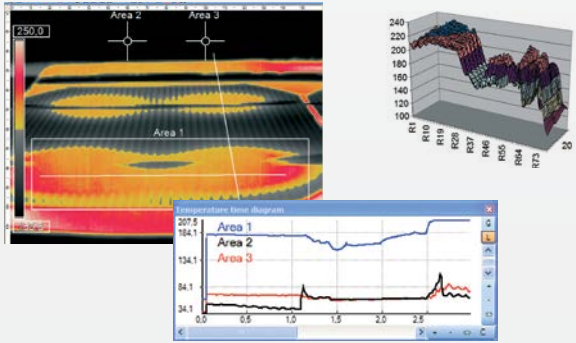

### Comprehensive IR camera software

- License-free analysis software and complete SDK included
- Intuitive user interface
- Camera remote control via software
- Displays several camera images in different windows
- Compatible with Windows 7, 8 and 10
- Data output via PIF hardware interface using up to 3 analog channels

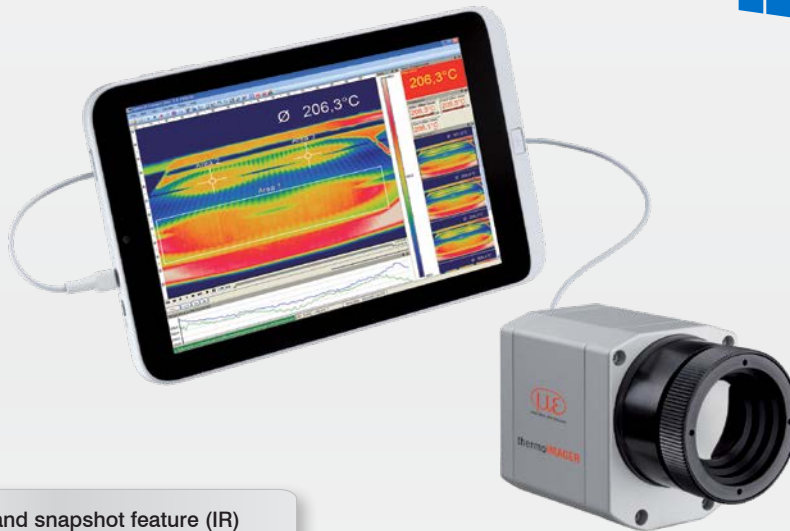

### Video recording and snapshot feature (IR)

- Recording of video sequences and individual images for later analysis or documentation
- Adjustable frame rate to reduce data volume
- Display of snapshot process for direct analysis

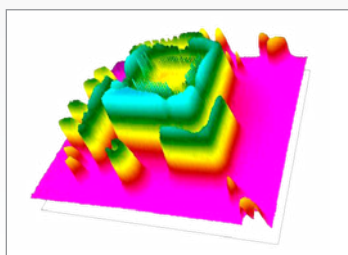
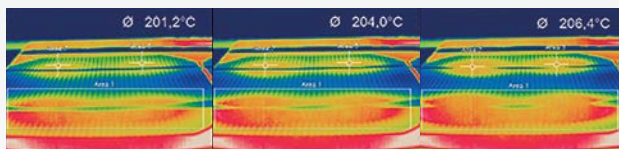

### Online and offline data analysis

- Real-time temperature information (°C or °F) in main window, as digital display or graphic display
- Detailed analysis using measuring fields, automatic hotspot/coldspot search
- Logical linking of temperature information
- Slow-motion replay without connected camera
- Various layout functions and color palettes to highlight thermal contrasts

### Temperature data analysis and documentation

- Triggered data collection
- Radiometric video sequences (\*.ravi) and snapshots (\*.tiff)
- Thermal images as \*.tiff or \*.csv, \*.dat text files incl. complete temperature information
- Data transfer in real time to other software programs via DLL or COM port interfaces

## Lenses thermoIMAGER TIM 160S

TIM 160S	Focal length [mm]	Angle	Minimum measurement distance*	Distance to measurement object [m]													
					0.05	0.1	0.2	0.3	0.5	1	2	4	6	10	30	100	
160 x 120 px																	
30° Standard lens	5	30°	0.2 m	HFOV [m]	0.032	0.057	0.109	0.160	0.263	0.542	1.08	2.15	3.22	5.4	16.1	53.6	
		23°		VFOV [m]	0.024	0.044	0.083	0.122	0.201	0.397	0.79	1.57	2.36	3.9	11.8	39.2	
		38°		DFOV [m]	0.040	0.072	0.137	0.201	0.330	0.672	1.34	2.66	3.99	6.6	19.9	66.4	
		3.33 mrad		IFOV [mm]	0.17	0.33	0.67	1.0	1.7	3.3	6.7	13.3	20.0	33.3	100.0	333.3	
12° Telephoto lens	13	12°	0.3 m	HFOV [m]	0.021		0.042	0.063	0.105	0.211	0.421	0.841	1.26	2.1	6.3	21.0	
		9°		VFOV [m]	0.016		0.032	0.048	0.079	0.158	0.315	0.630	0.94	1.6	4.7	15.7	
		15°		DFOV [m]	0.027		0.053	0.079	0.132	0.263	0.526	1.051	1.58	2.6	7.9	26.3	
		1.33 mrad		IFOV [mm]	0.13		0.27	0.40	0.66	1.3	2.7	5.3	8.0	13.3	39.8	132.8	
55° Wide angle lens	3	55°	0.2 m	HFOV [m]	0.058	0.110	0.214	0.318	0.527	1.05	2.09	4.17	6.25	10.4	31.2	104.1	
		40°		VFOV [m]	0.040	0.077	0.149	0.221	0.366	0.73	1.45	2.90	4.35	7.2	21.7	72.4	
		68°		DFOV [m]	0.071	0.134	0.261	0.388	0.641	1.275	2.54	5.08	7.62	12.69	38.0	126.8	
		5.57 mrad		IFOV [mm]	0.28	0.56	1.1	1.7	2.8	5.6	11.1	22.3	33.4	55.7	167.2	557.4	
80° Super wide angle lens	2	80°	0.2 m	HFOV [m]	0.088	0.169	0.331	0.492	0.816	1.63	3.25	6.48	9.72	16.2	48.6	162.0	
		54°		VFOV [m]	0.056	0.107	0.210	0.313	0.518	1.03	2.06	4.12	6.17	10.3	30.8	102.8	
		96°		DFOV [m]	0.104	0.200	0.391	0.583	0.967	1.93	3.84	7.68	11.52	19.2	57.6	191.8	
		7.73 mrad		IFOV [mm]	0.39	0.77	1.5	2.3	3.9	7.7	15.5	30.9	46.4	77.3	231.8	772.7	

FOV: Horizontal expansion of the total measuring field at the object level; VFOV: Vertical expansion of the total measuring field at the object level;  
DFOV = Diagonal expansion of the total measuring field at the object level; IFOV: Size of the individual pixels at the object level

\* Please note: The measurement accuracy of the camera may lie outside of the specifications for distances below the defined minimum measurement distance.

## Sensors and Systems from Micro-Epsilon



Sensors and systems for displacement, distance and position



Sensors and measurement devices for non-contact temperature measurement



Measuring and inspection systems for metal strips, plastics and rubber



Optical micrometers and fiber optics, measuring and test amplifiers



Color recognition sensors, LED analyzers and inline color spectrometers

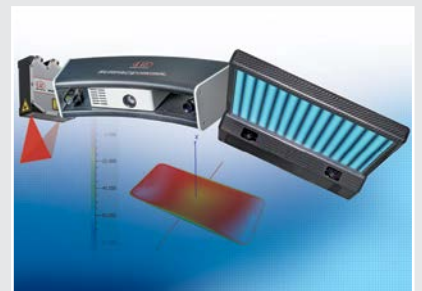

3D measurement technology for dimensional testing and surface inspection