











More Precision

optoNCDT // Laser displacement sensors (triangulation)





-  **Laser Line averages across shiny metallic or structured surfaces**
-  **Four models with measuring ranges from 2 mm to 50 mm**
-  **Real Time Surface Compensation**
-  **Adjustable measuring rate up to 7.5 kHz**
-  **Analog (U/I) and digital output**
-  **Adjustable filter functions (firmware)**
-  **High flex cables for dragchain or robot use**
-  **Calibration certificate included**

The compact optoNCDT 1750LL is perfectly suitable for measurements against shiny and structured surfaces. The point-shaped laser beam is widened using a lens to form an oval point. Therefore, physically induced interferences can be easily filtered enabling measurements on shiny surfaces. Due to its compact size, the sensor can easily be integrated into restricted installation space.

optoNCDT 1750LL (2/10/20/50 mm)

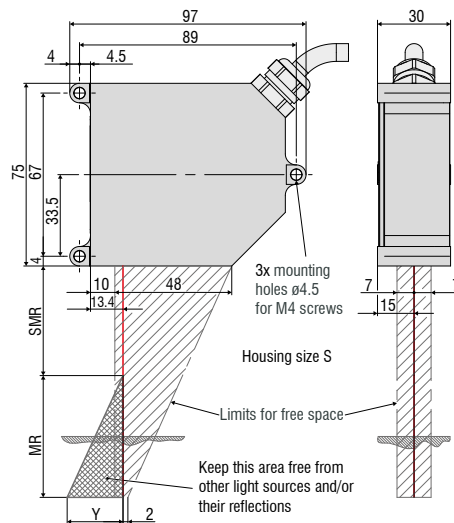

Connector (sensor side)

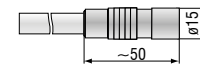

Connector (sensor cable)

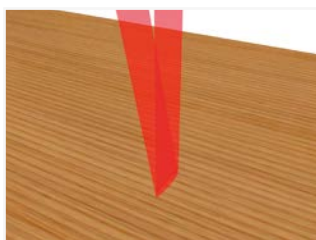
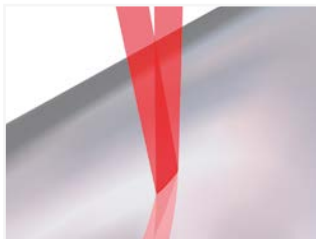
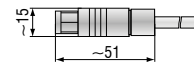

MR	SMR	Y
2	24	2
10	30	7
20	40	12
50	45	25

Model	ILD1750-2LL	ILD1750-10LL	ILD1750-20LL	ILD1750-50LL
Measuring range	2 mm	10 mm	20 mm	50 mm
Start of measuring range	24 mm	30 mm	40 mm	45 mm
Midrange	25 mm	35 mm	50 mm	70 mm
End of measuring range	26 mm	40 mm	60 mm	95 mm
Linearity	$\leq 1.6 \mu\text{m}$	$\leq 6 \mu\text{m}$	$\leq 12 \mu\text{m}$	$\leq 30 \mu\text{m}$
	$\leq \pm 0.08 \%$ FSO	$\leq 0.06 \%$ FSO		
Repeatability ²⁾	0.1 μm	0.4 μm	0.8 μm	2 μm
Measuring rate	continuously adjustable 0.3 ... 7.5 kHz			
	6 adjustable stages: 7.5 kHz / 5 kHz / 2.5 kHz / 1.25 kHz / 625 Hz / 300 Hz			
Light source	semiconductor laser <1 mW, 670 nm (red)			
Permissible ambient light with 2.5 kHz	10,000 lx			
Laser safety class	Class 2 in accordance with DIN EN 60825-1 : 2015-07			
Spot diameter	SMR	85 x 240 μm	120 x 405 μm	185 x 485 μm
	MMR	24 x 280 μm	35 x 585 μm	55 x 700 μm
	EMR	64 x 400 μm	125 x 835 μm	195 x 1200 μm
Temperature stability ¹⁾	0.025 % FSO/°C		0.01 % FSO/°C	
Operating temperature	0 ... +50 °C			
Storage temperature	-20 ... +70 °C			
Control inputs/outputs	1x HTL/TTL Laser on/off; 1x HTL/TTL multifunction input Trigger in / slave in / zero setting / mastering / teach 2x error outputs (error & limit value): npn, pnp, push pull 1x RS422 synchronization input (trigger in, sync in, master/slave, master/slave alternating)			
Measurement value output	analog	4 ... 20 mA; 0 ... 5 V / 0 ... 10 V; 16 bit; freely scalable within the measuring range		
	digital	RS422 / 18bit		
Operation	button	select & function buttons for interface selections, mastering (zero), teach, presets, quality slider, frequency selection, factory settings		
	web interface	application-specific presets; peak selection, video signal; freely selectable averaging possibilities; data reduction; setup management ²⁾		
Supply voltage	11 ... 30 VDC			
Power consumption	< 3 W (24 V)			
Sensor cable	standard	0.25 m pigtail with 14-pole ODU connector		
	option	extension: 3 / 10 m		
Synchronization	possible for simultaneous or alternating measurements			
Protection class	IP65			
Vibration	2 g / 20 ... 500 Hz			
Shock	15g / 6 ms			
Weight (with 25 cm cable)	approx. 550 g			

FSO = Full Scale Output; The specified data apply to a white, diffuse reflecting surface (reference: ceramics)

¹⁾ based on digital output

²⁾ Connection to PC via IF2001/USB (optionally available)

SMR = start of measuring range; MMR = midrange; EMR = end of measuring range

High performance sensors made by Micro-Epsilon



Sensors and systems for displacement and position



Sensors and measurement devices for non-contact temperature measurement



2D/3D profile sensors (laser scanner)



Optical micrometers, fiber optic sensors and fiber optics



Color recognition sensors, LED analyzers and color inline spectrometer



Measurement and inspection systems