



More Precision

optoNCDT ILR // Laser distance sensors





- Measuring range up to 80m on diffuse reflecting surfaces, up to 150m with reflector
- Option with integral heating
- Easy adjustment with laser sighting
- Precise measurement on various surfaces
- Practical mounting grooves for easy installation
- Accessories for harsh environments

Sensors in the optoNCDT ILR 1181/1182/1183 series are optoelectronic sensors for non-contact distance and displacement measurement for industrial applications. Both sensors operate according to the phase comparison principle, whereby higher precision can be achieved. They can be aligned and positioned in use with a visible laser beam with little effort.

The optoNCDT ILR 1182 series operates with a 50Hz measuring rate and is therefore suitable for fast processes. The mounting grooves on the housing offer flexible mounting options for many situations.

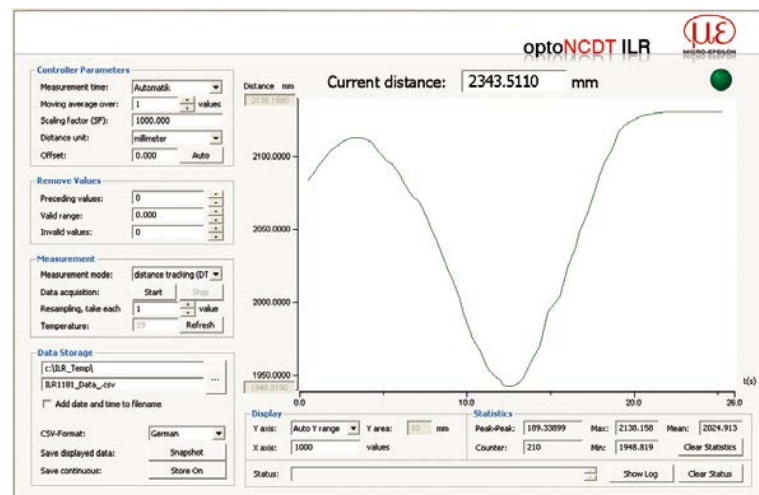
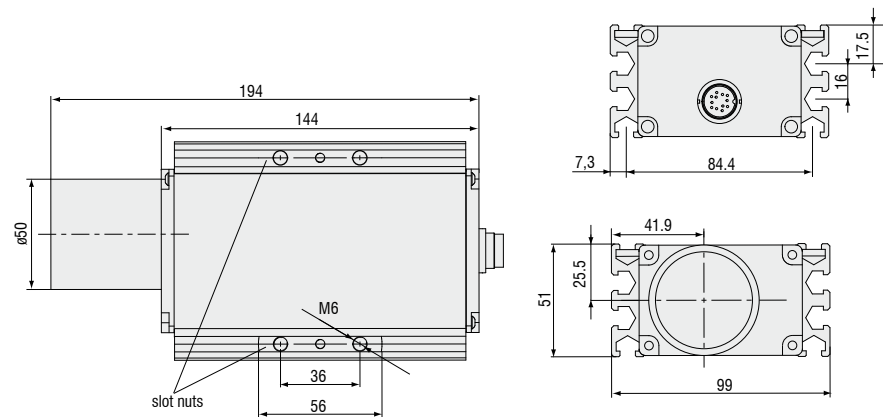

Configuration and measurement software for ILR1181 and ILR1182

Model	ILR1181-30	ILR1182-30	ILR1183-30
Measuring range ¹⁾	black 6%	0.4 ... 17m	
	grey 10%	0.1 ... 30m	
	white 90%	0.1 ... 50m	
	reflector	50 ... 150m (reflector film ILR-RF118x)	
Linearity ²⁾	±2mm (+15°C ... +30°C), ±5mm (-40°C ... +47°C)		
Resolution	0.1mm		
Repeatability	≤0.5mm		
Response time ¹⁾	100ms ... 6s	20ms ... 6s	20ms ... 6s
Laser class (IEC 825-1/EN 60825-1)	red 650nm, laser class 2		
Operation temperature	-10°C ... +47°C (optional -40°C ... +47°C, with integrated heating)		
Storage temperature	-40°C ... +70°C		
Limit outputs	QA (max. 500mA)	QA/QB (max. 500mA)	
Switching points	free adjustable		
Switching hysteresis	free adjustable		
Trigger input (not compatible with integral heating)	trigger edge and delay selectable, trigger pulse of max 24V		
Serial interface	RS232 or RS422 3) adjustable, max 38.4 kBaud	SSI interface (RS422), 24Bit, Gray-encoded, 50kHz ... 1MHz	
Profibus ³⁾	-	Profibus (RS485) 9.6kBaud ... 12MBaud ³⁾	
Operation mode	external triggering, single/continuous measurement, distance tracking		
Analog output	4 ... 20mA (16 Bit DA)	-	
Temperature stability	≤50ppm/°C		
Supply	10 ... 30 VDC		
Max. consumption	<1.5W at 24 V (<24W with heating)		3.2W at 24V (<26W with heating)
Connection	12-pin M16	1 x 12-pin M16 2 x 5-pin M12 B-encoded	
Protection class	IP 65		
Material (housing)	aluminium strangeness profile, powder-coated		
Vibration/Shock	500g, 0.5ms, 1 shock/axis (DIN ISO 9022-30-08-1)		
	10g, 6ms, 1000 shocks/axis (DIN ISO 9022-3-31-01-1)		
Weight	980g		
EMV	EN 61000-6-2, EN 55011		
Accessoires	page 14 - 15		

¹⁾ depending on target reflectance, ambient light influences and atmospheric conditions

²⁾ with statistical spread of 95%

³⁾ sensor configuration via profibus interface

Product identification

ILR 118x - 30 (x x)

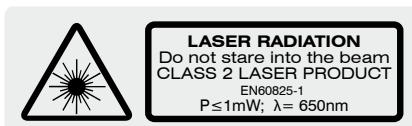
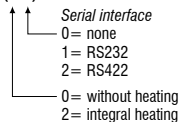

optoNCDT ILR 1181/1182/1183 operate with a wavelength of 650nm (visible, red). The maximum optical output is ≤ 1 mW. The sensors are classified in Laser Class 2. Class 2 lasers are not notifiable and a laser protection officer is not required either.

Spot diameter ILR1181/1182/1183



High performance sensors made by Micro-Epsilon



Sensors and systems for displacement and position



Sensors and measurement devices for non-contact temperature measurement



2D/3D profile sensors (laser scanner)



Optical micrometers, fibre optic sensors and fibre optics



Color recognition sensors, LED analyzers and color online spectrometer

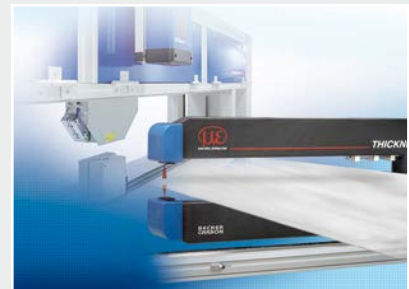

Measurement and inspection systems