



# More Precision

interfero**METER** // White light interferometer





- Absolute measurement with nanometer accuracy, suitable for the measurement of e.g. step profiles

- Compact and robust sensors with large offset distance

- Measuring rate up to 6 kHz for high speed measurements

- Ethernet / EtherCAT / RS422 / PROFINET / EtherNet/IP

- Robust controller with passive cooling

- Easy configuration via web interface

#### Absolute distance measurement with nanometer resolution

The IMS5400-DS white light interferometer opens up new perspectives in industrial distance measurement. The controller has an intelligent evaluation feature and enables absolute measurements with nanometer accuracy at a relatively large offset distance. Compared to other absolute measuring optical systems, the IMS5400-DS offers an unsurpassed combination of accuracy, measuring range and offset distance.

#### Small light spot for the smallest of details and structures

The sensors generate a constantly small light spot over the entire measuring range. The light spot diameter is only 10  $\mu\text{m}$  and allows the detection of small details such as structures on semiconductors and miniaturized electronic components.

#### Absolute measurement of step profiles

Unlike interferometers based on relative measurements, the IMS5400-DS also enables the measurement of step profiles. Thanks to the absolute measurement, the scanning is performed with high signal stability and precision. When measuring on moving objects, the differences in height of heels, steps and depressions can thus be reliably detected.

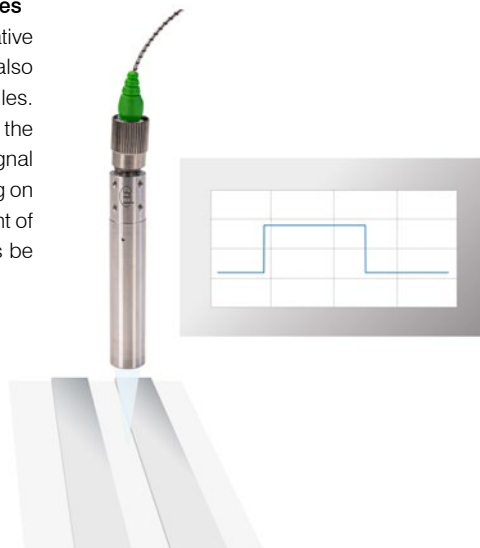

Due to their extremely compact size, these sensors can also be integrated into restricted spaces.

Model		IMS5400-DS
Measuring range		2.1 mm
Start of measuring range		approx. 19 mm
Resolution <sup>1)</sup>		< 1 nm
Measuring rate		continuously adjustable from 100 Hz to 6 kHz
Linearity <sup>2)</sup>		< ±50 nm
Temperature stability	Sensor	Linearity typ. 0.1 nm / K (without offset displacement)
	Controller	temperature compensated, stability < 10 ppm between +15 ... +35 °C
Light source		NIR-SLED, wavelength 840 nm
Laser safety class		Class 1 according to DIN EN 60825-1: 2015-07
Light spot diameter <sup>3)</sup>		10 μm
Max. tilt angle <sup>4)</sup>		±2°
Target material		Glass, reflecting or diffuse surfaces <sup>5)</sup>
Supply voltage		24 VDC ± 15 %
Power consumption		approx. 10 W (24 V)
Signal input		sync in, trigger in, 2x encoders (A+, A-, B+, B-, index)
Digital interface		Ethernet / EtherCAT / RS422 / PROFINET <sup>6)</sup> / EtherNet/IP <sup>6)</sup>
Analog output		4 ... 20 mA / 0 ... 10 V (16 bit D/A converter)
Switching output		Error1-Out, Error2-Out
Digital output		sync out
Connection	optical	pluggable optical fiber via E2000 socket (controller) and FC socket (sensor); standard length 3 m, 5 m and 10 m; other cable lengths on request; bending radius: static 30 mm, dynamic 40 mm
	electrical	3-pin supply terminal strip; encoder connection (15-pin, HD-sub socket, max. cable length 3 m, 30 m with external encoder supply); RS422 connection socket (9-pin, Sub-D, max. cable length 30 m); 3-pin output terminal strip (max. cable length 30 m); 11-pin I/O terminal strip (max. cable length 30 m); RJ45 socket for Ethernet (out) / EtherCAT (in/out) (max. cable length 100 m)
Assembly	Sensor	Clamping, mounting adapter (see accessories)
	Controller	free-standing, DIN rail mounting
Temperature range	Storage	-20 ... +70 °C
	Operation	Sensor: +5 ... +70 °C; Controller: +15 ... +35 °C
Shock (DIN EN 60068-2-27)		15 g / 6 ms in XY axis, 1000 shocks each
Vibration (DIN EN 60068-2-6)		2 g / 20 ... 500 Hz in XY axis, 10 cycles each
Protection class (DIN EN 60529)		IP40 (controller and sensor)
Material	Sensor	Stainless steel
	Controller	Aluminum housing, passive cooling
Control and display elements		Multifunction button: two adjustable functions and reset to factory setting after 10 s; web interface for setup: selectable presets, freely selectable averaging possibilities, data reduction, setup management; 6 x color LEDs for intensity, range, SLED, pilot laser, status and power; pilot laser: switchable for sensor alignment (laser LED 635 nm, laser class 1, performance < 0.2 mW)

All data at constant ambient temperature (24 ± 2 °C)

<sup>1)</sup> Measuring rate 0.5 kHz, moving averaging over 64 values, measured at the front of a glass plate in the mid of the measuring range (2 sigma)

<sup>2)</sup> Maximum deviation from reference system over the entire measuring range, measured on front surface of ND filter

<sup>3)</sup> In the mid of the measuring range

<sup>4)</sup> Maximum sensor tilt angle that produces a usable signal on polished glass (n = 1.5) in the mid of the measuring range. The accuracy decreases when approaching the limit values.

<sup>5)</sup> Non-transparent materials require optically dense surface at a wavelength of 840 nm

<sup>6)</sup> Optional connection via interface module (see accessories)

IMS5400-DS sensor

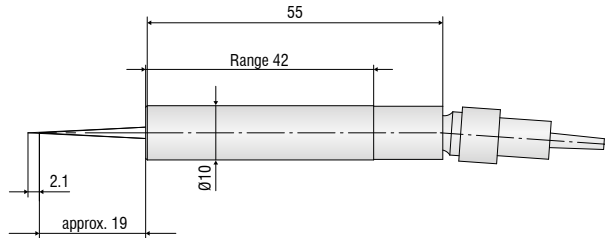

IMS5400-TH45 sensor

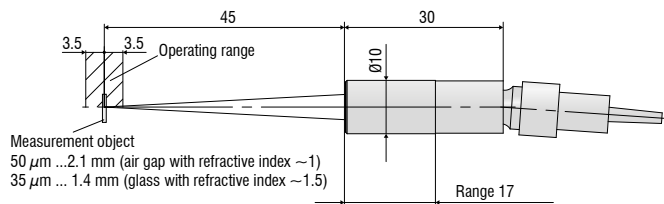

IMS5400-TH70 sensor

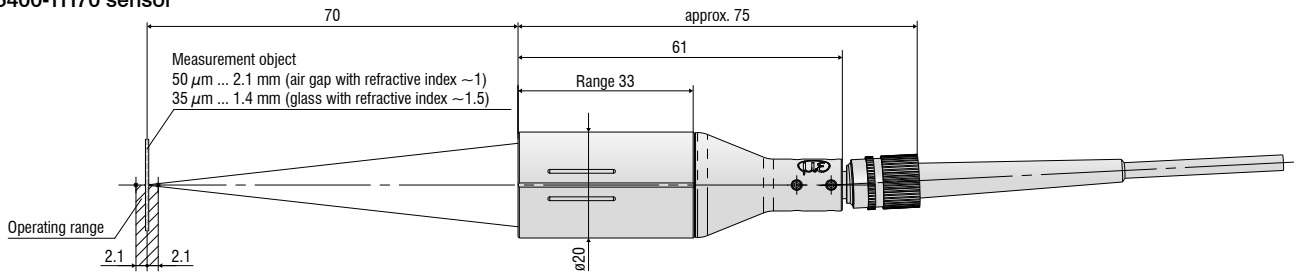

IMS5400-DS / IMS5400-TH / IMS5600-DS controllers

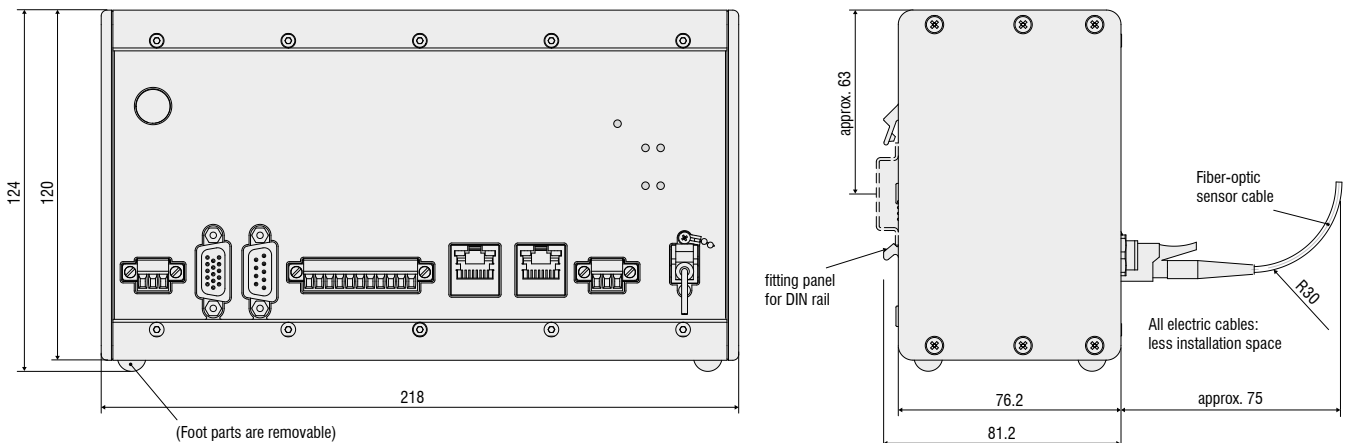

**Cable**

Standard E2000/APC (controller) and FC/APC connector (sensor)

- C5401-2            Optical fiber, length 2 m
- C5401-3            Optical fiber, length 3 m
- C5401-5            Optical fiber, length 5 m
- C5401-10          Optical fiber, length 10 m
- Other lengths up to 20 m on request

Drag chain E2000/APC (controller) and FC/APC connector (sensor)

- C5401-3(010)      Optical fiber, length 3 m
- C5401-5(010)      Optical fiber, length 5 m
- C5401-10(010)    Optical fiber, length 10 m
- Other lengths up to 20 m on request

Vacuum cable FC/APC connector

- C5400-1/VAC      Optical fiber, length 1 m
- C5400-2/VAC      Optical fiber, length 2 m
- C5400-5/VAC      Optical fiber, length 5 m

**Flange for vacuum feed through**

- C5405/VAC/1/CF16    CF flange
- C5405/VAC/1/KF16    KF flange

**Mounting adapter**

- MA5400- 10          Mounting adapter for IMP-DS19/ -TH45
- MA5400- 20          Mounting adapter for IMP-TH70

**Other accessories**

- SC2471-x/IF2008    IMC5400/5600 connector cable+ IF2008/PCIE, length 3 m / 10 m
- SC2471-x/RS422/OE    IMC5400/5600 interface cable + IF2001/USB, length 3 m / 10 m
- IF2001/USB          RS422/USB converter
- IF2008/PCIE        Interface card
- IF2030/PNET        Interface module for PROFINET integration
- PS2020              Power supply 24 V / 2.5 A
- EC2471-3/OE        Encoder cable, 3 m

**E2000/APC standard connector**

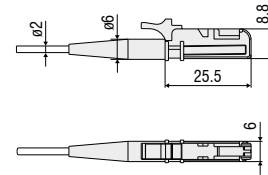

**FC/APC standard connector**

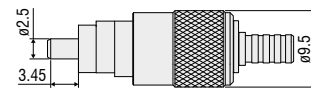

C5405/VAC/1/CF16  
C5405/VAC/1/KF16

**Accessories: Sensor mounting adapter**

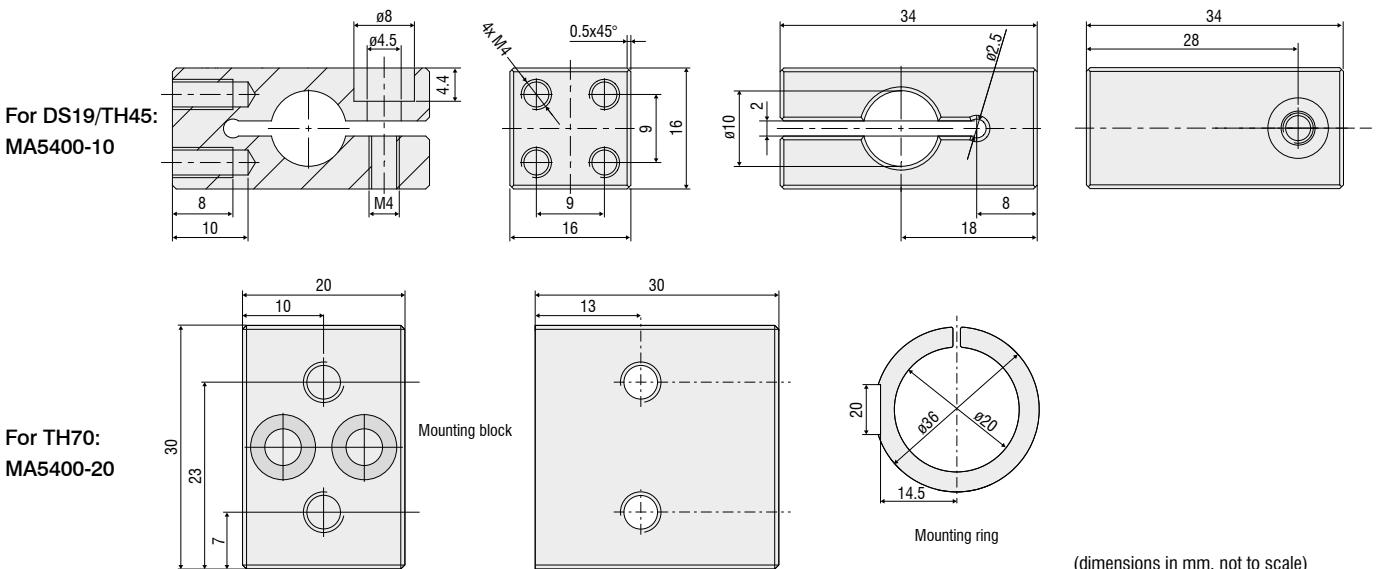

(dimensions in mm, not to scale)

## Sensors and Systems from Micro-Epsilon



Sensors and systems for displacement, position and dimension



Sensors and measurement devices for non-contact temperature measurement



Measuring and inspection systems for quality assurance

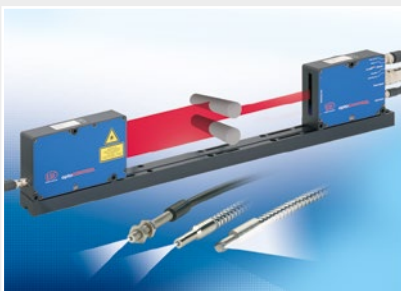

Optical micrometers, fiber optics, measuring and test amplifiers



Color recognition sensors, LED Analyzers and inline color spectrometers



3D measurement technology for dimensional testing and surface inspection