







More Precision.

indu**SENSOR** // Linear inductive displacement sensors





-  **Proven LVDT technology**
-  **Measuring ranges $\pm 1 \dots \pm 25$ mm**
-  **Extremely accurate also under difficult ambient conditions**
-  **Long-term stability**
-  **Robust design IP67**

LVDT displacement sensors have a plunger which moves freely in the sensor housing. The plunger is joined to the object by a thread to transfer the movement of the measuring object. The measurement process in the sensor takes place without contact and is therefore wear-free.

The displacement sensors are primarily used to measure and monitor movements, displacements, positions, strokes, deflections, dislocations, etc. in vehicles, machines and systems.

The high sensor resolution is only limited by the noise of the sensor controller. Another advantage of the symmetric LVDT sensors is their zero point stability. The sensors are supplied with an excitation frequency of 1 to 5 kHz depending on the measuring range and an excitation voltage of $0.4V_{eff}$. Adapted sensor controllers are available for this purpose.

With appropriate setting possibilities for the excitation frequency and excitation voltage, the sensors can also be operated with alternative controllers.

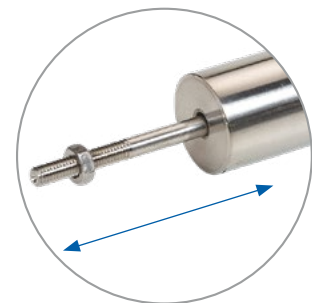

Freely moving plunger

Article designation

DT	A-	10-	D-	3-	CA-	W
Options (on request): W Welded sensor housing (water proof up to 5 bar) P Pressure-resistant sensor housing with tightness test (up to 100 bar) F Pressure-resistant mounting flange O-ring seal H High-temperature sensor models up to 200 °C with integral Teflon cable (only for sensor models with -CA/-CR connections)						
Axial connections			Radial connections			
CA integral cable (3m)			CR integral cable (3 m)			
SA plug-in connection			SR plug-in connection			
Linearity: 5 (± 0.5 %)		3 (± 0.3 %)		1.5 (± 0.15 %)		
Function: displacement sensor						
Measuring range in mm						
Excitation AC						
Principle: Differential Transformer (LVDT)						



Model		DTA-1D	DTA-3D	DTA-5D	DTA-10D	DTA-15D	DTA-25D
Series		CA, SA	CA, SA	CA, SA	CA, SA	CA, SA, CR, SR	CA, SA, CR, SR
Measuring range		±1 mm	±3 mm	±5 mm	±10 mm	±15 mm	±25 mm
Linearity	≤ ±0.5 % FSO	-	-	-	-	-	≤ ±300 μm
	≤ ±0.3 % FSO	≤ ±6 μm	≤ ±18 μm	≤ ±30 μm	≤ ±60 μm	≤ ±90 μm	on request
	≤ ±0.15 % FSO	≤ ±3 μm	≤ ±9 μm	≤ ±15 μm	on request		-
Temperature stability ¹⁾	Zero	≤ 70 ppm FSO/K					
	Max. temp. error	≤ 150 ppm FSO/K					
Sensitivity		133 mV / mm/V	85 mV / mm/V	53 mV / mm/V	44 mV / mm/V	45 mV / mm/V	33 mV / mm/V
Excitation frequency		5 kHz			2 kHz	1 kHz	
Excitation voltage		550 mV					
Connection	CA/CR	integrated cable (3 m) with open ends; radial or axial cable outlet depending on series; cable diameter 4.6 mm; min. bending radius 20 mm (fixed installation)					
	SA/SR	5-pin connector; radial or axial output depending on series (see accessories for connection cable)					
Temperature range	Storage	-40 ... +80 °C					
	Operation	-20 ... +80 °C (optional up to 200 °C on request)					
Pressure resistance		atmospheric pressure (optional 5 bar or 100 bar on front side on request)					
Shock (DIN EN 60068-2-27)		40 g / 6 ms in 3 axes, 1000 shocks each 100 g / 6 ms in 3 axes, 3 shocks each					
Vibration (DIN EN 60068-2-6)		±1.5 mm / 10 ... 58 Hz in 2 axes, 10 cycles each; ±20 g / 58 ... 500 Hz in 2 axes, 10 cycles each					
Protection class (DIN EN 60529)		IP67 (plugged)					
Material		Stainless steel (housing)					
Weight	Sensor CA/CR	approx. 90 g	approx. 100 g	approx. 100 g	approx. 105 g	approx. 195 g	approx. 230 g
	Sensor SA/SR	approx. 15 g	approx. 20 g	approx. 25 g	approx. 30 g	approx. 106 g	approx. 145 g
	Plunger	approx. 2 g	approx. 3 g	approx. 4 g	approx. 5 g	approx. 12 g	approx. 17 g
Compatibility		MSC7401, MSC7802, MSC7602					

FSO = Full Scale Output

¹⁾ Determined according to box method (-40 ... +80 °C)

Sensor types with measuring range up to ±10 mm (inner diameter 2.7 mm; plunger diameter 2 mm)

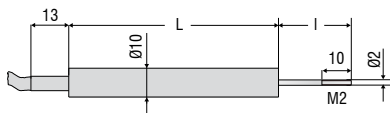

Type - CA
with integral cable

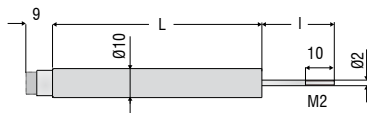

Type - SA
with axial plug connection

Sensor types with measuring range ±15 mm and ±25 mm (inner diameter 4.8 mm; plunger diameter 4 mm)

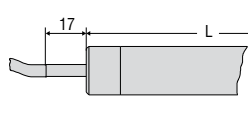

Type - CA
with integral cable

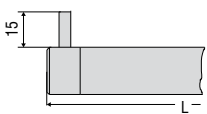

Type - CR
with integral cable (radial)

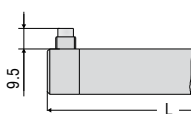

Type - SR
with radial plug connection

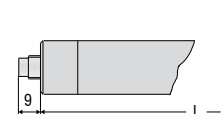

Type - SA
with axial plug connection

Basic model	DTA-1D-		DTA-3D-		DTA-5D-		DTA-10D-		DTA-15D-				DTA-25D-			
	CA	SA	CA	SA	CA	SA	CA	SA	CA	CR	SA	SR	CA	CR	SA	SR
Connection	CA	SA	CA	SA	CA	SA	CA	SA	CA	CR	SA	SR	CA	CR	SA	SR
Housing length L	40 mm	40 mm	57 mm	57 mm	73 mm	73 mm	87 mm	87 mm	106.5 mm				143.5 mm			
Plunger length l ¹⁾	19 mm		29 mm		30 mm		35 mm		51 mm				62 mm			
Housing diameter	10 mm								20 mm							

¹⁾ Plunger in zero position (±10% of measuring range ±1 mm)

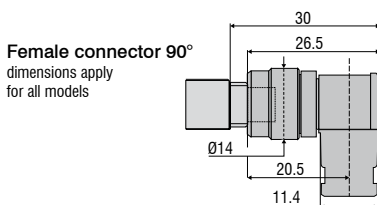

Female connector 90°
dimensions apply for all models

Female connector
dimensions apply for all models

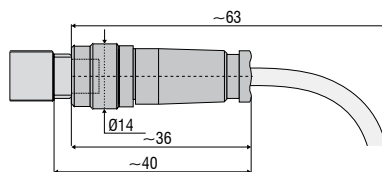

Dimensions in mm, not to scale

Sensors and Systems from Micro-Epsilon



Sensors and systems for displacement, distance and position



Sensors and measurement devices for non-contact temperature measurement



Measuring and inspection systems for metal strips, plastics and rubber



Optical micrometers and fiber optics, measuring and test amplifiers



Color recognition sensors, LED analyzers and inline color spectrometers



3D measurement technology for dimensional testing and surface inspection