



# More Precision

capa**N**CDT // Capacitive displacement sensors and systems





- Compact and robust construction
- High temperature stability
- Nanometer repeatability
- Suitable for all conductive materials
- 24V (9 – 36V) standard power supply for industrial applications
- Ideal for OEM applications
- Suitable for practically all sensors

#### System design

The capaNCDT 6110 single channel capacitive electronics is compatible with all Micro-Epsilon capacitive sensor ranges. The analog measuring system stands out due to its compact design together with high performance. Due to the miniaturized design and its ease of use, the capaNCDT 6120 is ideally suited to integration in machines and facilities. The flexible 9-36V power supply, enables the capaNCDT 6110 series to also be used in mobile applications. The capaNCDT 6110 stands out due to its excellent price/performance ratio, which makes it particularly suitable for high volume applications.

#### A measuring system consists of:

- Capacitive displacement sensor
- Sensor cable
- Controller
- Supply and signal output cable

#### Accessories:

- Power supply

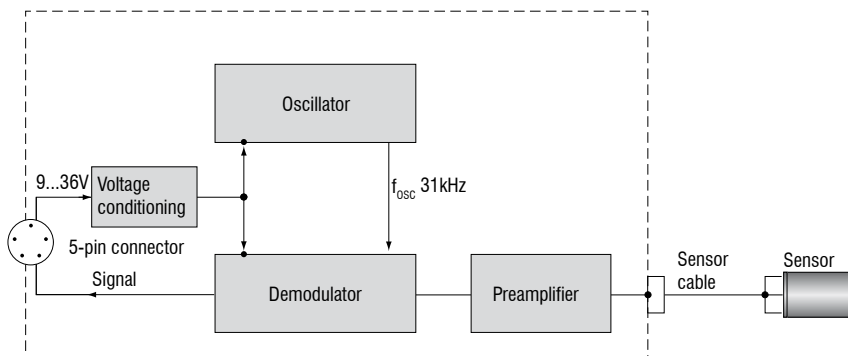

Controller type	DT6110	DT6110/ECL2	DT6112
Resolution static	0.01% FSO	0.01% FSO	0.01% FSO
Resolution dynamic	0.015% FSO (1kHz)	0.015% FSO (1kHz)	0.03% FSO (20kHz)
Bandwidth	1kHz (-3dB)	1kHz (-3dB)	20kHz (-3dB)
Linearity (typ.)	≤ 0.05% FSO	≤ 0.05% FSO	≤ 0.1 % FSO
Sensitivity deviation	≤ 0.1% FSO	≤ 0.1% FSO	≤ 0.1 % FSO
Long-term stability	< 0.05% FSO/month	< 0.05% FSO/month	< 0.05% FSO/month
Synchronous operation	no	no	no
Insulator measurement	no	no	no
Temperature stability	200ppm	200ppm	200ppm
Temperature range (during operation)	Sensor	-50 ... +200°C	-50 ... +200°C
	Controller	+10 ... +60°C	+10 ... +60°C
Temperature range (storage)	-10 ... +75°C	-10 ... +75°C	-10 ... +75°C
Supply	24VDC/55mA (9 - 36V)	24VDC/55mA (9 - 36V)	24VDC/55mA (9 - 36V)
Output	0 ... 10V (short-circuit-proof), optional: ± 5V, 10 ... 0V	0 ... 10V (short-circuit-proof), optional: ± 5V, 10 ... 0V	0 ... 10V (short-circuit-proof), optional: ± 5V, 10 ... 0V
Sensors	suitable for all sensors	suitable for all sensors	suitable for all sensors
Sensor cable	CC cable ≤ 1m CCm cable = 1.4m CCg cable = 2m	CC cable ≤ 2m CCm cable = 2.8m CCg cable = 4m	CC cable ≤ 1m CCm cable = 1.4m CCg cable = 2m

FSO = Full Scale Output

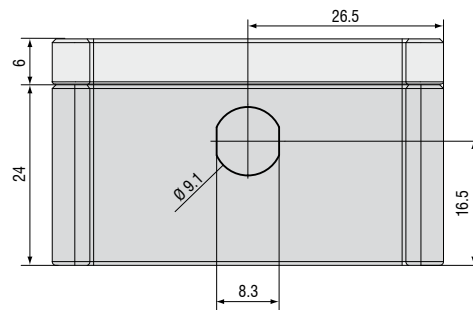
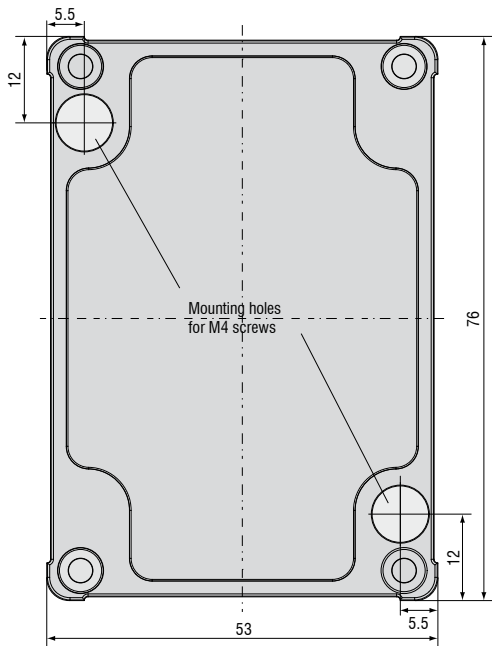

Sensor cable	Cable CCx,x / CCx,x/90	Cable CCmx,x / CCmx,x/90	Cable CCgx,x / CCgx,x/90
Description	Low-outgassing cable up to 4m length, for applications in clean rooms	Low-outgassing cable up to 4.2m length, for applications in clean rooms, UHV and EUV	Robust cable up to 8m length, for industrial applications
Temperature stability	-100°C to +200°C	-100°C to +200°C	-20°C to +80°C (permanent) -20°C to +100°C (10,000 h)
Outer diameter	3.1mm ±0.1mm	2.1mm ±0.1mm	3.1mm ±0.1mm
Bending radius	3x cable diameter during installation; 7x cable diameter for movement; 12x cable diameter recommend at continuous movement		

Design	Cable with connector type C for sensors CS005 / CS02 / CS05 / CSE05 / CS08 / CSE1						Cable with connector type B for sensors CS1 / CS1HP / CS2 / CSE2 / CS3 / CS5 / CS10					
	2 x straight connector			1 x straight / 1 x 90° connector			2 x straight connector			1 x straight / 1 x 90° connector		
Model	CCx,xC	CCmx,xC	CCgx,xC	CCx,xC/90	CCmx,xC/90	CCgx,xC/90	CCx,xB	CCmx,xB	CCgx,xB	CCx,xB/90	CCmx,xB/90	CCgx,xB/90
Standard 1m	•		•	•		•	•		•	•		•
1.4 m		•			•			•			•	
2 m	•		•	•		•	•		•	•		•
2.8 m		•			•			•			•	
3 m	•			•			•			•		
4 m			•			•			•			•
4.2 m		•			•			•			•	
6 m			•			•			•			•
8 m			•			•			•			•

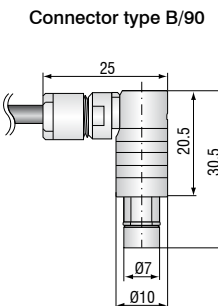
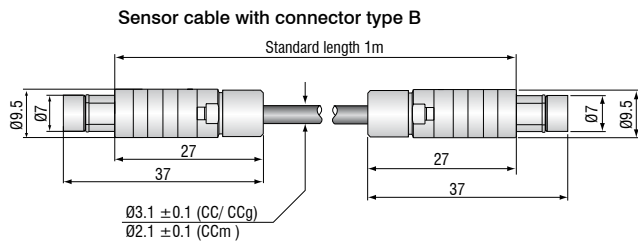
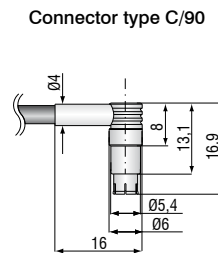
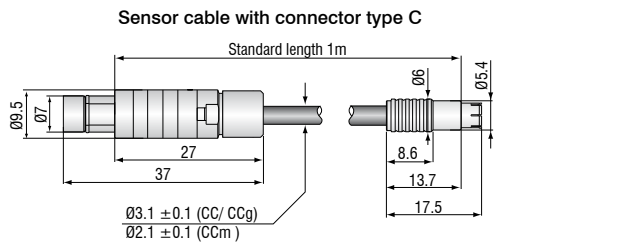

Accessories	capaNCDT	6110	6200	6500
<b>MC2.5</b> Micrometer for sensor calibration, range 0 - 2.5mm, Resolution 0.1µm. Suitable for sensors CS005 to CS2		•	•	•
<b>MC25D</b> Digital micrometer for sensor calibration, range 0 - 25mm, adjustable offset (zero). Suitable for all sensors.		•	•	•
<b>HV/B</b> Vacuum feed through triaxial		•	•	•
<b>UHV/B</b> Vacuum feed through triaxial for ultra-high vacuum		•	•	•
<b>PC6200-3/4</b> Power-/trigger cable, 4 pin, 3m			•	
<b>SCAC3/4</b> Signal output cable, (necessary for multi-channel applications), 4 pin, 3m			•	
<b>SCAC3/5</b> Signal output cable, analog, 5 pin, 3m		•		
<b>SC6000-1,0</b> Synchronization cable, 5 pin, 1m			•	•
<b>CA5</b> Preamplifier cable 5 pin, 5m				•
<b>PS2020</b> Power supply for DIN rail mounting; Input 230VAC (115VAC); Output 24VDC / 2.5 A; L/W/H 120x120x40mm		•	•	

**HV/B Vacuum feed through** (Art.-no. 0323050)

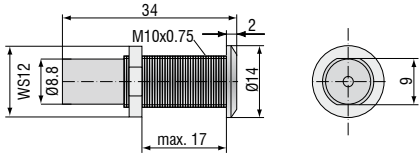

Max. leak rate  $1 \times 10^{-7}$  mbar · l s<sup>-1</sup>, compatible with connector type B

**UHV/B Vacuum feed triax weldable** (Art.-no. 0323346)

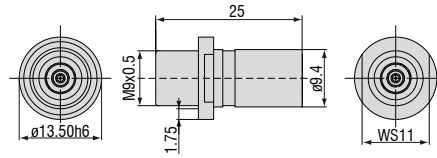

Max. leak rate  $1 \times 10^{-9}$  mbar · l s<sup>-1</sup>, compatible with connector type B

**UHV/B Vacuum feed triax with flange CF16** (Art.-no. 0323349)

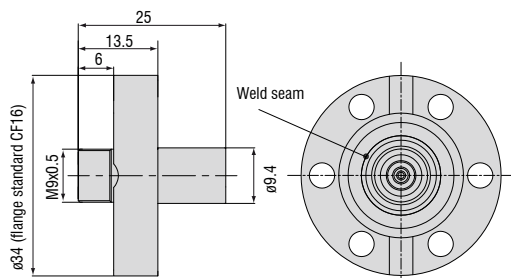

Max. leak rate  $1 \times 10^{-9}$  mbar · l s<sup>-1</sup>, compatible with connector type B

**UHV/B Vacuum feed triax screwable** (Art.-no. 0323370)

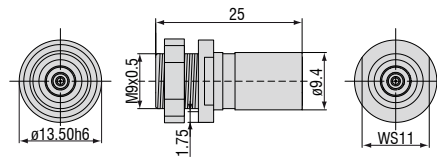

Max. leak rate  $1 \times 10^{-9}$  mbar · l s<sup>-1</sup>, compatible with connector type B

**SCA3/4 Signal output cable** (Art.-no. 2902104)

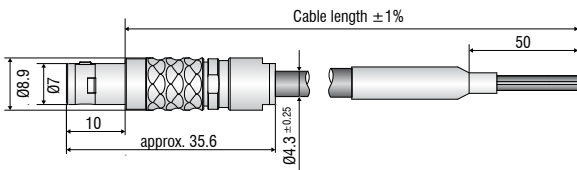

**SCA3/5 Signal output cable** (Art.-no. 2902112)

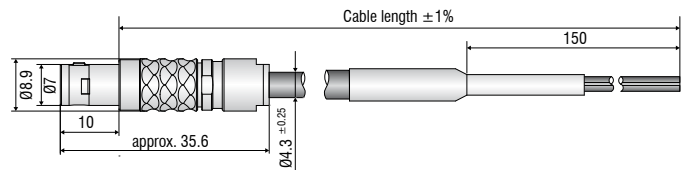

**PC6200-3/4 Power-/trigger cable** (Art.-no. 2901881)

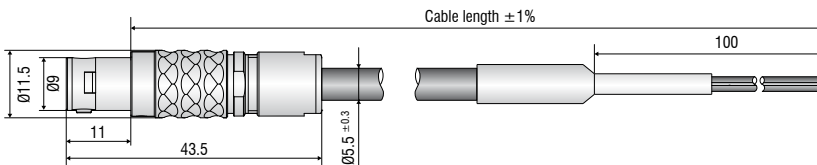

**SC6000-1,0 Synchronization cable** (Art.-no. 2903473)

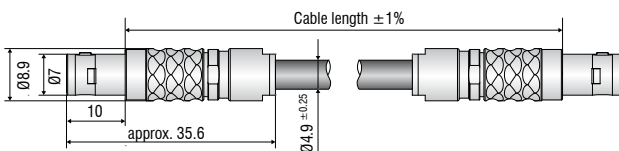

**CA5 Preamplifier cable** (Art.-no. 2903180)

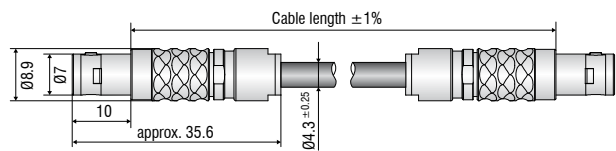

## High performance sensors made by Micro-Epsilon



Sensors and systems for displacement and position



Sensors and measurement devices for non-contact temperature measurement



2D/3D profile sensors (laser scanner)



Optical micrometers, fibre optic sensors and fibre optics



Color recognition sensors, LED analyzers and color inline spectrometer



Measurement and inspection systems