



More Precision

thermo**IMAGER** TIM // Compact thermal imaging cameras





thermoIMAGER TIM M05

Compact infrared camera for the short-wave range for non-contact temperature measurement of molten metal and metallic surfaces from 900°C to 2000°C

- Highly dynamic CMOS detector with resolution up to 764 x 480 pixels
- Special wavelength range from 500nm to 540nm minimizes errors due to unknown emissivity
- Wide measuring range from 900°C to 2000°C (without sub-ranges)
- Frame rates up to 1kHz for fast processes
- Real-time analog output with 1ms response time
- Comprehensive software package and SDK
- Ideally suitable for laser processing applications as radiation above 540 nm is blocked excellently

Software

- Display of the thermal image in real time with recording function (video, snapshot)
- Complete set up of parameters and remote control of the camera
- Detailed analysis of fast, thermodynamic processes
- Output of analog temperature or alarm values via the process interface
- Digital communication via RS232 or DLL for software integration

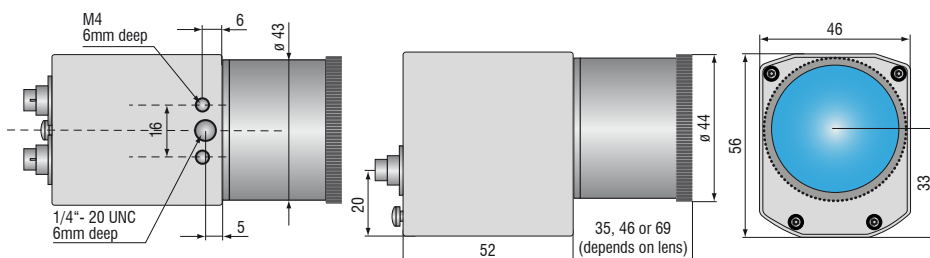
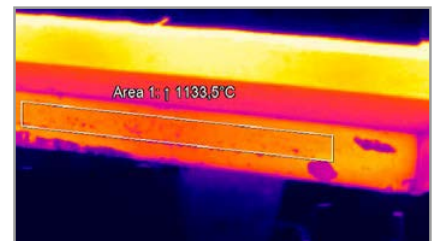
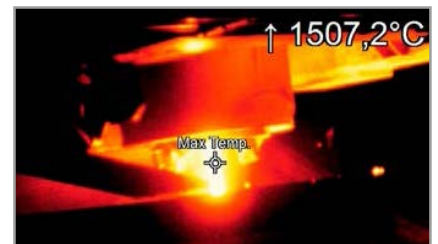
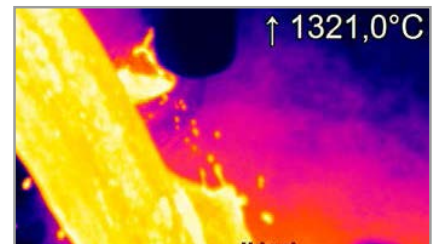

Model	TIM M05	
Optical resolution	764 x 480 pixels @ 32Hz 382 x 288 pixels @ 80Hz (switchable to 27Hz) 72 x 56 pixels @ 1kHz ¹⁾ 764 x 8 pixels @ 1 kHz (fast line-scan mode) ¹⁾	
Temperature ranges	900°C to 2000°C (27Hz mode) 950°C up to 2000°C (80Hz and 32Hz mode) 1100°C up to 2000°C (1kHz mode)	
Spectral range	500 to 540nm	
Frame rate	Up to 1kHz / 1ms real-time analog output (0 - 10V) from 8 x 8 pixels (freely selectable)	
System accuracy	±1.5% of reading	
Lenses	FOV @ 764 x 480 px: 26° x 16° (f = 25mm) ³⁾	FOV @ 382 x 288 px: 13° x 10° (f = 25mm) ³⁾
Thermal sensitivity (NETD)	< 2K (1400°C) for 27Hz, 32Hz and 80Hz < 2.5K (1400°C) for 1kHz	
Detector	CMOS (15µm x 15µm)	
Outputs/digital	USB 2.0 / optional GigE	
High-speed analog output (@ 1kHz mode)	1ms real-time analog output (0 – 10V) of 8 x 8 pixels (freely selectable positions)	
Standard process interface (PIF)	0-10V input, digital input (max. 24V), 0-10V output	
Industry process interface (PIF)	2x 0-10V inputs, digital input (max. 24V), 3x 0-10V outputs, 3x relays (0-30V/ 400mA), fail-safe relay	
Cable length (USB)	1m (standard), 5m, 10m 5m and 10m also as high temperature USB cable (180°C)	
Power supply	USB powered	
Tripod mount	¼-20 UNC	
Protection class	IP67 ²⁾	
Ambient temperature range	5°C to 50°C	
Storage temperature	-40°C to 70°C	
Relative humidity	20 to 80%, non-condensing	
Vibration	IEC 60068-2-6 (sinus-shaped) / IEC 60068-2-64 (broadband noise)	
Shock	IEC 60068-2-27 (25g and 50g)	
Housing (size)	46mm x 56mm x 90mm	
Weight	320g, incl. lens	

PC requirements: minimum 1.5GHz, 1GB RAM, Windows XP SP 2 or Windows 7

¹⁾ Can be placed anywhere within the FOV

²⁾ Only applies when lens protection tube is used

³⁾ Please note: measurement accuracy can be out of specification with distances below 500mm

Scope of supply

TIM M05

- TIM process camera
incl. a selectable lens
- Lens cap incl. protective window
- Instruction Manual
- USB cable 1m
- Software for real-time processing and
analyzing thermal images
- Tripod mount
- PIF cable incl. terminal block (1m)
- Aluminum case
- Optional:
Cooling Jacket, high temperature cable

thermoIMAGER TIM USB Server Gigabit**Simple cable extension for the thermoIMAGER TIM series and pyrometers**

- Fully compatible with USB 2.0, data transfer rate 1.5/ 12/ 480Mbps,
USB transfer modes: Control, Bulk, Interrupt, Isochronous
- For all models in the thermoIMAGER TIM series 1x TIM640, 1x TIM4xx, 2x TIM160, 1x TIM200
- Full TCP/IP support incl. routing and DNS
- Two independent USB ports
- Galvanic isolation 500V_{RMS} (network connection)
- Remote configuration via web-based management

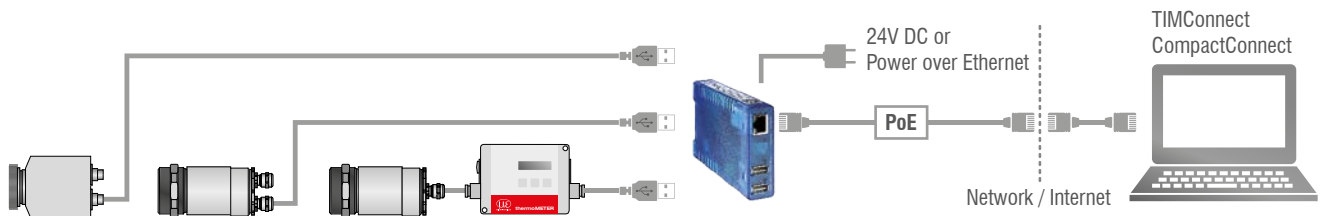

Model	TIM USB Server Gigabit
USB ports	Two independent USB ports
USB speed	480Mbit/s
Network	10/100/1000 BaseT (max. 1000Mbit/s)
Power supply	Power over Ethernet (PoE) class 3 (6.49 - 12.95W) or via screw terminal DC 24V ... 48V ($\pm 10\%$)
Power consumption	External power supply (24V DC) without USB devices: typ. 120mA External power supply (24V DC) with 2 USB devices each 2.5W: typ. 420mA
Ambient temperature range	Storage: -40 ... 85°C In operation, individually assembled: 0 ... 50°C
Permissible relative humidity	0 - 95% (non-condensing)
Housing	Compact plastic housing for DIN rail mount, 105 x 75 x 22mm
Weight	200g
Scope of supply	1 x USB Server Gigabit 24V DC power supply unit Quick guide ¹⁾
USB protocols	USB 1.0 / 1.1 / 2.0 Control / Bulk / Interrupt / Isochronous
Protocols for direct network connection	TCP/IP: Socket Auxiliary protocols: ARP, DHCP, HTTP, PING Inventory keeping, group management

¹⁾ TIMConnect CD or Compact Connect CD: USB redirector | WuTility Management Tool | Operating instructions (DE/EN)

Industrial process interface

Camera and process control for use in industrial environments

- Industrial process interface with 3 analog / alarm outputs, 2 analog inputs, 1 digital input, 3 alarm relays
- 500V AC_{RMS} galvanic isolation between TIM camera und process
- Separate fail-safe relay output
- TIM hardware with all cable connections and the TIMConnect software are permanently monitored during operation

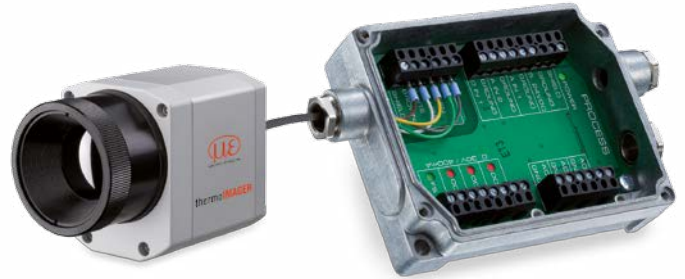

Exemplary fail-safe monitoring of the TIM camera with connected PLC

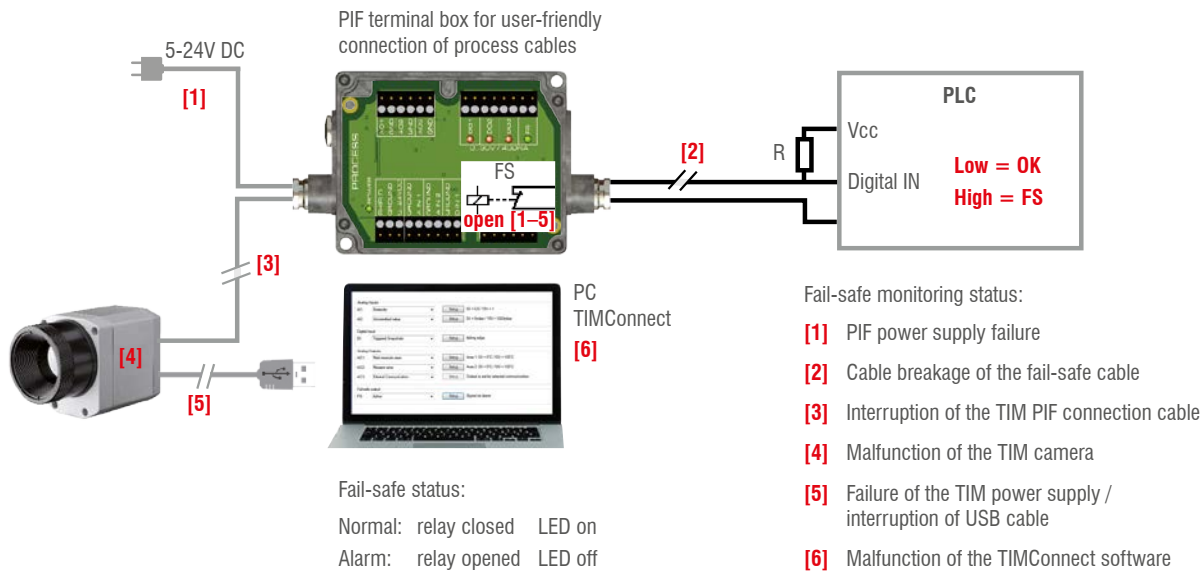

Model	Industrial process interface
Protection class	IP65 (NEMA-4)
Ambient temperature range	-30°C to 85°C
Storage temperature	-30°C to 85°C
Relative humidity	10 to 95%, non-condensing
Vibration resistance	IEC 60068-2-6 (non-condensing)/ IEC 60068-2-64 (broadband noise)
Shock	IEC 60068-2-27 (25g and 50g)
Weight	610g (with 5m cable)
Cable length	5m, optional 10m and 20m or HT cable (180°C or 250°C)
Power supply	5 to 24VDC
LED indicators	2 green LEDs for voltage and fail safe / 3 red LEDs for alarm relay status
Insulation	500V AC _{RMS} between TIM camera und process
Outputs	3 analog / alarm outputs 3 alarm relays ¹⁾
Inputs	2 analog inputs 1 digital input
Ranges	0 – 10V (for AO 1 – 3) ²⁾ 0 – 30V / 400mA (for alarm relays DO1 – 3) 0 – 10V (for AI 1 – 2) 24V (for DI)
Analog inputs	Emissivity setting Ambient temperature compensation Reference temperature Uncommitted value Flag control Triggered snapshots, triggered recordings, triggered line scan camera
Digital input	Flag control Triggered snapshots, triggered recordings, triggered line scan camera
Analog outputs	Main measuring range Measuring range Internal temperature Flag status Alarm Frame synchronization Fail safe External communication

¹⁾ active when AO1, 2 or 3 is / are programmed as alarm output ²⁾ depends on supply voltage

thermoIMAGER TIM NetPC / NetPCQ PC solution for thermoIMAGER TIM applications

TIM NetPC is a professional, embedded industrial PC solution with passive cooling (fanless) for thermoIMAGER applications and is suitable for top hat rail mounting. The NetPC and the TIM camera can be operated in combination as stand-alone system. Remote maintenance via Ethernet is possible. Data provided by the TIM camera can be stored directly on the NetPC where customer-specific software can also be installed. A recovery-stick is included in the scope of delivery.

- Supports all thermoIMAGER TIM models
- Supports 120Hz (TIM 160), up to 80Hz (TIM 4x0), up to 32Hz (TIM 640) frame rates
- Including TIMConnect software
- Monitor via VGA (analog)
- Integrated watchdog feature
- Optional: up to 20m USB cable, high temperature USB cable, extendable up to 100m Ethernet cable (PoE)



thermoIMAGER TIM NetPC

Model	TIM NetPC	TIM NetPCQ
Ambient temperature range		0 to 50°C
Storage temperature		-20 to 60°C
Relative humidity		10 to 95%, non-condensing
Dimensions		165 x 65 x 130mm (W x H x D)
Material (housing)		Anodized aluminum
Weight		1000g
Vibration		IEC-2-6: 3G, 11 - 200Hz, each axis
Shock		IEC-2-27: 50G, 11ms, each axis
Operating system		Windows 7 embedded
Power supply		12 - 24V DC
Power consumption		approx. 9.5W without TIM [0.76 A with 12V]
Cooling		passive cooling (fanless)
Processor	Intel® Atom™ 2600 @ 2x1.6GHz Dual	Intel® Atom™ J1900 @ 4x2.4GHz
Hard drive		integrated 64GB SSD
RAM		2GB DDR3 RAM 800MHz
Ports	1Gbit/s (GigE), 2 x RS 232, 4 x USB 2.0, VGA	1 GigE, 2 x RS232 / 485, 3 x USB 2.0, 1 x USB 3.0, VGA
Additional functions		1x status LED

TIMConnect SOFTWARE FEATURES

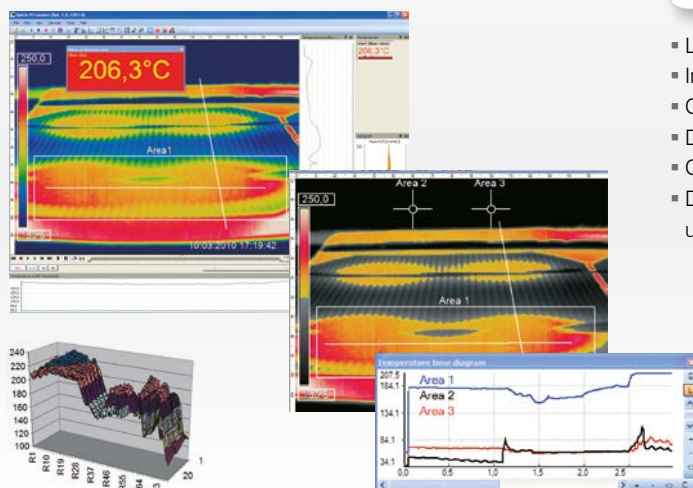

Comprehensive IR camera software

- License-free analysis software and complete SDK included
- Intuitive user interface
- Camera remote control via software
- Displays several camera images in different windows
- Compatible with Windows 7, 8 and 10 and Linux (Ubuntu)
- Data output via PIF hardware interface using up to 3 analog channels



thermoIMAGER TIM NetBox

Miniature PC for thermoIMAGER TIM series

- Can be integrated into CoolingJacket Advanced Extended
- Miniature PC for TIM 160/ 4x0 standalone mode for cable extension
- Supports 120Hz (TIM 160 up to 70Hz (TIM 4x0) frame rate, 32Hz (TIM 640)
- Integrated hardware and software watchdog
- Optional: up to 20m USB cable, high temperature USB cable, extendable up to 100m Ethernet cable (PoE)

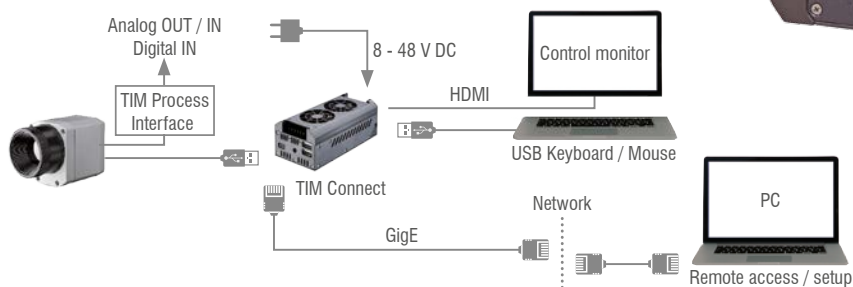

thermoIMAGER TIM NetBox

Model	TIM NetBox
Operating temperature	0°C up to 50°C
Storage temperature	-20°C to 75°C
Relative humidity	10 to 95%, non-condensing
Material (housing)	Anodized aluminum
Dimensions	113 x 57 x 47mm
Weight	385g
Vibration	IEC 60068-2-6 (sinus-shaped) / IEC 60068-2-64 (broadband noise)
Shock	IEC 60068-2-27 (25g and 50g)
Operating system	Windows 7 Professional
Power supply	8 ... 48VDC or Power over Ethernet (PoE/ 1000BASE-T)
Power consumption	7.5W (+ additional 2.5W for TIM camera)
Cooling	Active via two integrated fans
Board	COM Express® mini embedded board
Processor	Intel® E3845 Quad Core, 1.91GHz
Hard drive	16GB SSD
RAM	2GB (DDR2, 533MHz)
Ports	2x USB 2.0, 1x USB 3.0, 1x Mini-USB 2.0, Micro-HDMI, Ethernet (Gigabit Ethernet)
Extensions	micro SDHC / SDXC card
Additional functions	4x status LEDs

Online and offline data analysis

- Real-time temperature information (°C or °F) in main window, as digital display or graphic display
- Detailed analysis using measuring fields, automatic hotspot/coldspot search
- Logical linking of temperature information
- Slow-motion replay without connected camera
- Various color palettes to highlight thermal contrasts

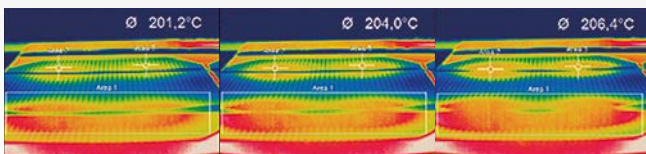

Video recording and snapshot feature (IR or BI-SPECTRAL)

- Recording of video sequences and individual images for later analysis or documentation
- Adjustable frame rate to reduce data volume
- Display of snapshot process for direct analysis

Temperature data analysis and documentation

- Triggered data collection
- Radiometric video sequences (*.ravi) and snapshots (*.tiff)
- Thermal images as *.avi / *.tiff or text files *.csv, *.dat incl. complete temperature information
- Data transfer in real time to other software programs via DLL or COM port interfaces

TIM 160 / 200	Focal length [mm]	Angle	Minimum measurement distance*	Distance to measurement object [m]													
					0.02	0.1	0.2	0.3	0.5	1	2	4	6	10	30	100	
160 x 120 px																	
23° Standard lens	10	23° 17° 29° 2.48mrad	0.2m	HFOV [m] VFOV [m] DFOV [m] IFOV [mm]	0.012 0.009 0.015 0.1	0.043 0.032 0.054 0.3	0.08 0.06 0.10 0.5	0.12 0.09 0.16 0.8	0.21 0.15 0.26 1.3	0.41 0.30 0.51 2.5	0.81 0.60 1.01 5.0	1.62 1.21 2.02 9.9	2.44 1.81 3.03 14.9	4.1 3.0 5.1 24.8	12.2 9.0 15.2 74.4	40.6 30.1 50.5 248.0	
6° Telephoto lens	35.5	6° 5° 8° 0.70mrad	0.5m	HFOV [m] VFOV [m] DFOV [m] IFOV [mm]					0.06 0.04 0.07 0.4	0.11 0.09 0.14 0.7	0.23 0.17 0.28 1.4	0.45 0.34 0.57 2.8	0.68 0.51 0.85 4.2	1.1 0.8 1.4 7.0	3.4 2.5 4.2 21.1	11.3 8.5 14.2 70.4	
48° Wide angle lens	5.7	41° 31° 51° 4.39mrad	0.2m	HFOV [m] VFOV [m] DFOV [m] IFOV [mm]	0.022 0.016 0.027 0.1	0.082 0.059 0.101 0.4	0.16 0.11 0.19 0.9	0.23 0.17 0.29 1.3	0.38 0.28 0.47 2.2	0.76 0.55 0.94 4.4	1.51 1.10 1.86 8.8	3.00 2.19 3.72 17.5	4.50 3.28 5.57 26.3	7.5 5.5 9.3 43.9	22.5 16.4 27.8 131.6	74.9 54.5 92.7 438.6	
72° Wide angle lens	3.3	72° 52° 89° 7.51mrad	0.2m	HFOV [m] VFOV [m] DFOV [m] IFOV [mm]	0.039 0.027 0.048 0.2	0.152 0.106 0.186 0.8	0.29 0.20 0.36 1.5	0.43 0.30 0.53 2.3	0.72 0.50 0.87 3.8	1.42 0.99 1.74 7.5	2.84 1.98 3.46 15.0	5.66 3.95 6.91 30.0	8.49 5.92 10.35 45.0	14.1 9.9 17.2 75.1	42.4 29.6 51.7 225.2	141.4 98.6 172.3 750.8	

TIM 400 / 450 / G7	Focal length [mm]	Angle	Minimum measurement distance*	Distance to measurement object [m]													
					0.02	0.1	0.2	0.3	0.5	1	2	4	6	10	30	100	
382 x 288 px																	
29° Standard lens	18.7	29° 22° 37° 1.34mrad	0.2m	HFOV [m] VFOV [m] DFOV [m] IFOV [mm]		0.060 0.045 0.074 0.1	0.11 0.08 0.14 0.3	0.16 0.12 0.20 0.4	0.27 0.20 0.33 0.7	0.53 0.40 0.66 1.3	1.0 0.78 1.3 2.7	2.1 1.6 2.6 5.4	3.1 2.3 3.9 8.0	5.2 3.9 6.5 13.4	15.6 11.7 19.5 40.1	52.1 39.0 65.1 133.7	
13° Telephoto lens (except for G7)	41	13° 10° 17° 0.61mrad	0.5m	HFOV [m] VFOV [m] DFOV [m] IFOV [mm]					0.12 0.09 0.15 0.3	0.23 0.17 0.29 0.6	0.47 0.35 0.58 1.2	0.94 0.70 1.17 2.5	1.40 1.05 1.75 3.7	2.3 1.7 2.9 6.1	7.0 5.2 8.8 18.4	23.4 17.5 29.2 61.2	
53° Wide angle lens	10.5	53° 40° 66° 2.38mrad	0.2m	HFOV [m] VFOV [m] DFOV [m] IFOV [mm]		0.11 0.08 0.14 0.2	0.21 0.15 0.26 0.5	0.31 0.23 0.38 0.7	0.51 0.37 0.63 1.2	1.0 0.73 1.2 2.4	2.0 1.4 2.5 4.8	4.0 2.9 4.9 9.5	6.0 4.3 7.4 14.3	9.9 7.2 12.2 23.8	29.7 21.6 36.7 71.5	99.0 71.9 122.3 238.4	
80° Wide angle lens	7.7	80° 56° 97° 3.25mrad	0.2m	HFOV [m] VFOV [m] DFOV [m] IFOV [mm]		0.182 0.119 0.218 0.3	0.35 0.23 0.41 0.7	0.84 0.55 1.00 1.6	0.84 0.54 1.00 1.6	1.65 1.08 1.97 3.3	3.29 2.14 3.92 6.5	6.55 4.28 7.83 13.0	9.82 6.41 11.73 19.5	16.4 10.7 19.5 32.5	49.0 32.0 58.5 97.4	163.4 106.6 195.1 324.7	

TIM 640 640 x 480 px	Focal length [mm]	Angle	Minimum measurement distance*	Distance to measurement object [m]											
					0.1	0.2	0.3	0.5	1	2	4	6	10	30	100
33° Standard lens	18.7	33° 25° 41° 0.91mrad	0.2m	HFOV [m]	0.068	0.13	0.19	0.31	0.60	1.20	2.38	3.57	5.9	17.8	59.3
				VFOV [m]	0.051	0.09	0.14	0.23	0.45	0.89	1.77	2.65	4.4	13.2	44.2
				DFOV [m]	0.085	0.16	0.23	0.38	0.75	1.49	2.97	4.45	7.4	22.2	74.0
				IFOV [mm]	0.1	0.2	0.3	0.5	0.9	1.8	3.6	5.5	9.1	27.3	90.9
15° Telephoto lens	41.5	15° 11° 19° 0.41mrad	0.5m	HFOV [m]				0.13	0.26	0.52	1.05	1.57	2.6	7.8	26.1
				VFOV [m]				0.10	0.20	0.39	0.79	1.18	2.0	5.9	19.6
				DFOV [m]				0.17	0.33	0.66	1.31	1.96	3.3	9.8	32.7
				IFOV [mm]				0.2	0.4	0.8	1.6	2.5	4.1	12.3	41.0
60° Wide angle lens	10.5	60° 45° 75° 1.62mrad	0.2m	HFOV [m]	0.128	0.25	0.36	0.59	1.17	2.32	4.63	6.94	11.6	34.6	115.4
				VFOV [m]	0.091	0.18	0.26	0.42	0.83	1.66	3.31	4.96	8.3	24.7	82.4
				DFOV [m]	0.157	0.30	0.44	0.72	1.43	2.85	5.69	8.52	14.2	42.6	141.8
				IFOV [mm]	0.2	0.3	0.5	0.8	1.6	3.2	6.5	9.7	16.2	48.6	161.9
90° Super wide angle lens	7.7	90° 64° 111° 2.21mrad	0.2m	HFOV [m]	0.220	0.43	0.63	1.03	2.03	4.04	8.06	12.07	20.1	60.3	200.8
				VFOV [m]	0.138	0.27	0.39	0.64	1.27	2.53	5.05	7.57	12.6	37.8	125.9
				DFOV [m]	0.260	0.50	0.73	1.21	2.39	4.76	9.50	14.24	23.7	71.1	237.0
				IFOV [mm]	0.2	0.4	0.7	1.1	2.2	4.4	8.8	13.2	22.1	66.2	220.8

FOV = Field of view; HFOV = Horizontal field of view; VFOV = Vertical field of view; DFOV = Diagonal dimension of the total measuring field at the object level; IFOV = Indicated field of view
Table with examples showing which measuring field sizes and pixel sizes are reached at which distance. Various lenses are available for optimal configuration of the camera.
Wide angle lenses have radial distortion due to the angle of their aperture. The TIMConnect software has an algorithm which corrects this distortion.

* Please note: The measurement accuracy of the camera may lie outside of the specifications for distances below the defined minimum measurement distance.



- Standard-, telephoto- and wide angle lenses for adaptation to different applications
- High quality germanium lenses and special anti-reflective coating for excellent optics
- Factory-calibrated lenses for easy exchange of optical system without recalibration

Measuring field sizes can be calculated online at www.micro-epsilon.com/optikkalkulator.

TIM M1 / TIM M05 ¹⁾	Focal length [mm]	Angle	Minimum measurement distance*	Distance to measurement object [m]											
					0.1	0.2	0.3	0.5	1	2	4	6	10	30	100
382 x 288 px	16	20° 15° 25° 0.94mrad	0.2m	HFOV [m]		0.07	0.11	0.18	0.36	0.72	1.43	2.15	3.6	10.7	35.8
				VFOV [m]		0.05	0.08	0.14	0.27	0.54	1.08	1.62	2.7	8.1	27.0
				DFOV [m]		0.09	0.13	0.22	0.45	0.90	1.79	2.69	4.5	13.5	44.9
				IFOV [mm]		0.2	0.3	0.5	0.9	1.9	3.8	5.6	9.4	28.1	93.8
f=25mm standard lens	25	13° 10° 16° 0.60mrad	0.5m	HFOV [m]	0.023	0.05	0.07	0.11	0.23	0.46	0.92	1.38	2.3	6.9	22.9
				VFOV [m]	0.017	0.03	0.05	0.09	0.17	0.35	0.69	1.04	1.7	5.2	17.3
				DFOV [m]	0.029	0.06	0.09	0.14	0.29	0.57	1.15	1.72	2.9	8.6	28.7
				IFOV [mm]	0.1	0.1	0.2	0.3	0.6	1.2	2.4	3.6	6.0	18.0	60.0
f=50mm telephoto lens	50	7° 5° 8° 0.30mrad	1.5m	HFOV [m]				0.06	0.11	0.23	0.46	0.69	1.1	3.4	11.5
				VFOV [m]				0.04	0.09	0.17	0.35	0.52	0.9	2.6	8.6
				DFOV [m]				0.07	0.14	0.29	0.57	0.86	1.4	4.3	14.4
				IFOV [mm]				0.2	0.3	0.6	1.2	1.8	3.0	9.0	30.0
f=75mm Super telephoto lens	75	4° 3° 5° 0.20mrad	2.0m	HFOV [m]					0.08	0.15	0.31	0.46	0.8	2.3	7.6
				VFOV [m]					0.06	0.12	0.23	0.35	0.6	1.7	5.8
				DFOV [m]					0.10	0.19	0.38	0.57	1.0	2.9	9.6
				IFOV [mm]					0.2	0.4	0.8	1.2	2.0	6.0	20.0

¹⁾ TIM M05 only available with OF25 lens | Please note: the camera provides 382 x 288 px in the 80Hz mode

TIM M1 / M05 with VGA ¹⁾ Resolution	Focal length [mm]	Angle	Minimum measurement distance*	Distance to measurement object [m]											
					0.1	0.2	0.3	0.5	1	2	4	6	10	30	100
764 x 480 px	16	39° 25° 46° 0.94mrad	0.2m	HFOV [m]		0.14	0.21	0.36	0.72	1.43	2.87	4.30	7.2	21.5	71.6
				VFOV [m]		0.09	0.14	0.23	0.45	0.90	1.80	2.70	4.5	13.5	45.0
				DFOV [m]		0.17	0.25	0.42	0.85	1.69	3.38	5.08	8.5	25.4	84.6
				IFOV [mm]		0.2	0.3	0.5	0.9	1.9	3.8	5.6	9.4	28.1	93.8
f=25mm standard lens	25	26° 16° 30° 0.60mrad	0.5m	HFOV [m]	0.046	0.09	0.14	0.23	0.46	0.92	1.83	2.75	4.6	13.8	45.8
				VFOV [m]	0.029	0.06	0.09	0.14	0.29	0.58	1.15	1.73	2.9	8.6	28.8
				DFOV [m]	0.054	0.11	0.16	0.27	0.54	1.08	2.17	3.25	5.4	16.2	54.1
				IFOV [mm]	0.1	0.1	0.2	0.3	0.6	1.2	2.4	3.6	6.0	18.0	60.0
f=50 mm telephoto lens	50	13° 8° 15° 0.30mrad	1.5m	HFOV [m]				0.11	0.23	0.46	0.92	1.38	2.3	6.9	22.9
				VFOV [m]				0.07	0.14	0.29	0.58	0.86	1.4	4.3	14.4
				DFOV [m]				0.14	0.27	0.54	1.08	1.62	2.7	8.1	27.1
				IFOV [mm]				0.2	0.3	0.6	1.2	1.8	3.0	9.0	30.0
f=75 mm Super telephoto lens	75	9° 5° 10° 0.20mrad	2.0m	HFOV [m]					0.15	0.31	0.61	0.92	1.5	4.6	15.3
				VFOV [m]					0.10	0.19	0.38	0.58	1.0	2.9	9.6
				DFOV [m]					0.18	0.36	0.72	1.08	1.8	5.4	18.0
				IFOV [mm]					0.2	0.4	0.8	1.2	2.0	6.0	20.0

¹⁾ TIM M05 is only available with OF25 lens | Please note: the camera provides 764 x 480 px in the 32Hz mode