

5. Laser Class

The gapCONTROL 2711 sensors operate with a semiconductor laser having a wavelength of 658 nm (visible/red). The laser operation is indicated visually by the LED on the sensor.

Laser Class 2M

The gapCONTROL 2711 sensors with a maximum laser power up to 10 mW are classified in Laser Class 2M (IIM). The following information labels are fitted to the sensor housing (front and rear side).

If both information labels are hidden in the installed state, the user must ensure that additional labels are fitted at the point of installation.

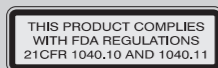
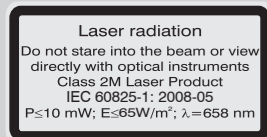

CAUTION

Hazard to the eye via laser radiation! Consciously close your eyes or turn away if the laser radiation impinges on the eye.

Lasers of Class 2M are not subject to notification and a laser protection officer is not required. Mark the laser area recognizable and everlasting.

Laser Class 3B

The gapCONTROL 2711 sensors with a maximum laser power up to 20 mW are classified in Laser Class 3B (IIIB).

CAUTION

Injury to the eye or the skin via laser radiation! Consciously close your eyes or turn away if the laser radiation impinges on the eye or the skin.

Class 3B (IIIB) laser sensors are notifiable and a laser protection officer is required either. During operation the laser area has to be restricted and marked. The following information label should be fitted to the sensor housing (front and rear side):

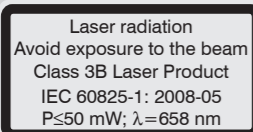

Sensors of Laser Class 3B (IIIB) need an external key switch to switch off the laser, see Chap. "Laser switching".

Beam attenuator

The beam attenuator prevents access to all laser and collateral radiation. The figures show the sensor with closed and open beam attenuator. The beam attenuator must be open during measurement.

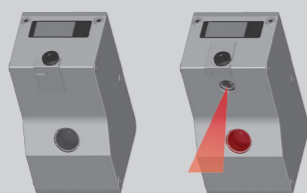

6. Connections, LED Displays

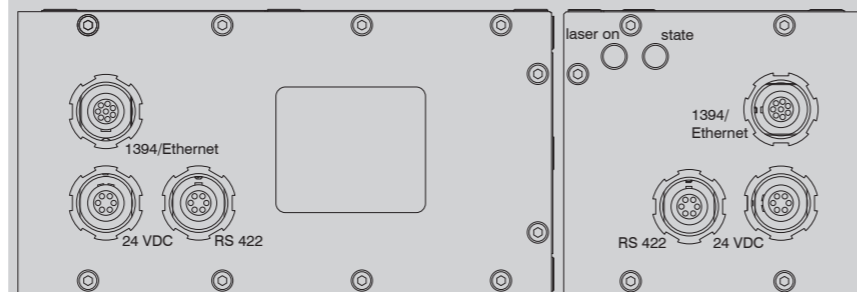

gapCONTROL 2711-x, top side

gapCONTROL 2711-x(001), rear side

The sensors are available in two versions: Sockets on the top side or on the rear side.

LED displays

LED "laser on"	Green: Laser on	Note: The "status" LED flashes green; long during active data transmission and short for controller accesses.
LED "state": Two-color LED (red / green)	Green: Measurement Green flashing: Data transmission Red flashing: Error code	

The state LED indicates different error conditions by flashing. If no flashing occurs for several seconds, no error has occurred.

Power supply (Power)

Pin no.	Assignment connector "24 VDC"						Range: 11 V – 30 V (Rated value 24 V) DC; maximum current 500 mA
	Standard Color PC2700; old version in ()			Options 002, 003, 004, 005 Color PC2700(002)			
1	24 V+	white	(red)	24 V+	pink	<p>View on solder pin side, male cable connector, counting direction anticlockwise</p>	
2	Laser help	n.c.	n.c.	LH+	gray		
3	Laser on/off	n.c.	n.c.	Laser off+	yellow		
4	Laser on/off	n.c.	n.c.	Laser off-	green		
5	Laser help	n.c.	n.c.	LH-	brown		
6	24 V GND	brown	(black or blue)	24 V GND	white		

The power supply is also possible using the FireWire connection cable, if the power supply needed is present in the PC with sufficient current intensity. When both voltages (1394 and power) are present, the higher voltage always takes over the supply of the sensor.

External laser switching

Series gapCONTROL 2711-x(002), gapCONTROL 2711-x(003), gapCONTROL 2711-x(004) and gapCONTROL 2711-x(005) offer this function.

Sensors of Laser Class 3B (IIIB) need an external key switch to switch off the laser.

Use a serial key switch inside the control circuit to switch off the laser. You will find details for the wiring in the instruction manual, Chap. 5.2.4.

RS422, Synchronization

Pin no.	Assignment connector "RS422"			View on solder pin side, male cable connector	The Pin numbers refer to the gapCONTROL 2711 unit. Micro-Epsilon recommends the use of the interface cable SC2700-4.5 RS422 from the optional accessories.
	RS422	General	9-pin Sub-D ¹		
1	RX1	CH1	2		
2	/RX1	/CH1	3		
5	GND1		5		
3	TX2	CH2	9		
4	/TX2	/CH2	1		
6	GND2		5		

The RS422 port can be used with either of the following configurations:

- RS422: Loading of programs and transmitting of measurement results (ASCII format).
- Synchronization/Triggering: Synchronization resp. triggering using switching signals.

¹⁾ Optional RS422 interface cable (SC2700-4,5RS422) from Micro-Epsilon, compatible to the RS422 to USB converter. All outputs or inputs are designed symmetrically. Internal terminating resistors 120 Ohm.

FireWire connection (1394), standard link to the PC

8-pin connector, ODU		6-pin connector,		Connector "1394"
Pin no.	Assignment	Pin no.	Assignment	
1	GND_FireWire	2	GND_FireWire	The Pin numbers refer to the gapCONTROL 2711 unit. Micro-Epsilon recommends using the FireWire connection cable SC2700-4.5 FireWire from the recommended accessories.
2	TPA+	4	TPB+	
3	TPA-	3	TPB-	
4	Screen	2	GND_FireWire	
5	TPB-	5	TPA-	
6	TPB+	6	TPA+	
7	Screen	2	GND_FireWire	
8	+24 V_FireWire	1	+24 V_FireWire	

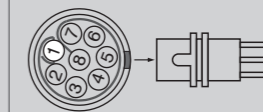

View on solder pin side ODU

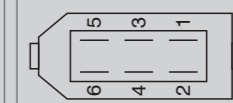

View on solder pin side FireWire



The gapCONTROL 2711 sensor can also be supplied with operating voltage from the PC on the 1394 connection socket. If its capacity is not sufficient, an appropriate voltage must be connected to the 24 VDC socket.

Use the recommended FireWire connection cable.

A power supply via free cores in the FireWire connection cable is possible if these wires are connected in the PC (Pin 1 to +8 ... 30 VDC, typically 12 VDC; Pin 2 to ground on the FireWire connector).

7. gapCONTROL 2711 with gapCONTROL Output Unit for Connection to an SPS

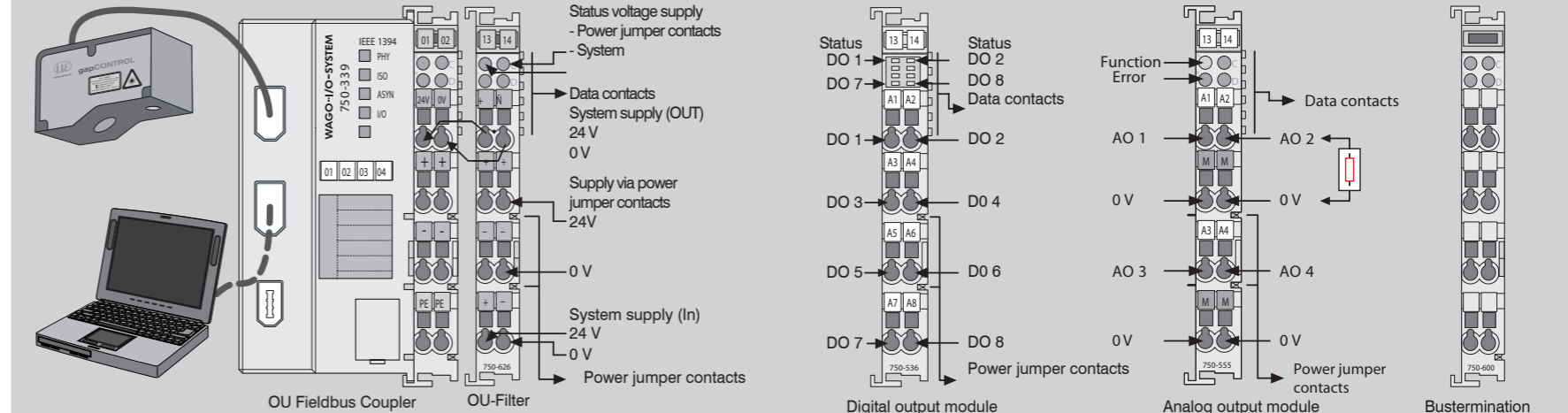



Assembly Instructions gapCONTROL 2711 FireWire

1. Warnings

Connect the power supply and the display-/output device in accordance with the safety regulations for electrical equipment. The power supply may not exceed the specified limits.

> Danger of injury, damage or destruction of the sensor

Avoid shock and vibration to the sensor. Avoid continuous exposure to dust and spray on the sensor. Avoid exposure to aggressive materials (e. g. washing agent, penetrating liquids or similar) on the sensor.

> Damage to or destruction of the sensor

Read the detailed instruction manual before operation of the sensor. You will find this online or on the provided CD.

2. Notes on CE Identification

The following applies to the gapCONTROL 2711: EU directive 2004/108/EC and EU directive 2011/65/EC, "RoHS" category 9 Products which carry the CE mark satisfy the requirements of the quoted EU directives and the European standards (EN) listed therein. The EC declaration of conformity is kept available according to EC regulation, article 10 by the authorities responsible at MICRO-EPSILON MESSTECHNIK GmbH & Co. KG Königbacher Straße 15 94496 Ortenburg /Germany

The measuring system is designed for use in industry and satisfies the requirements.

3. Proper Environment

- Protection class: IP 65
- Operating temperature: 0 to +50 °C (+32 to +122 °F), by free circulation of air
- Storage temperature: -20 to +70 °C (-4 to +158 °F)
- Humidity: 5 - 95 % (non-condensing)

4. Standard Equipment gapCONTROL 2711

- 1 Sensor gapCONTROL 2711 with integrated controller
- 1 Power supply cable PC2700-4.5, length 4.5 m; ODU round connector and free cable ends
- 1 CD with drivers, programs and documentation
- 1 Sensor inspection log / assembly instructions
- 1 Bag of accessories with one ODU male connector 6-pin (RS422), S31BQC-P06M-FG0-6000, and two protective caps for ODU female connector (6- or 8-pin)

- Select "No, not this time" and click "Next".
- Select „Install the software automatically (recommended)“ and click "Next".

The driver is now installed, followed by the dialog "Hardware Installation".



- Confirm this dialog with "Continue Installation".
- Click „Finish“, to complete the driver installation.

If you want to install the driver later, or if the driver installation is completed successfully, you can install the driver for gapCONTROL manually.

12. First Profile

- Now start the gapCONTROL Setup Software. Click on „Display Profiles“ in the main window.

If the software shows the error message "No gapCONTROL found" in the status line, please check the installed driver in the device manager (Start > Control Panel > System > Hardware > Device Manager).

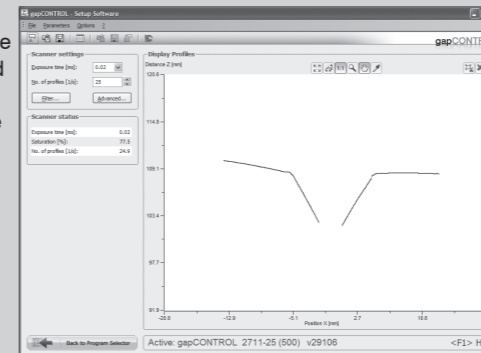

On the left side you can adjust the settings for your measurement task, the right side shows the profile data and information about the measurement.

13. Further Information

Please refer to the enclosed online manual. You will find details to the separate programs in the respective instruction manuals or in the instruction manual of this sensor, Chap. 6.2. You will find the instruction manuals online or on the provided CD.

www.micro-epsilon.com

MICRO-EPSILON Messtechnik GmbH & Co. KG

Königbacher Str. 15

94496 Ortenburg / Germany, Tel. +49 (0) 8542 / 168-0



X9771247.001-A051105GBR

Connect the supply voltage

Digital output modules need a field supply of 5 VDC or 24 VDC depending on the module type.

After mounting of the modules install the required wiring.

- Connect the "System supply (out)" terminals of the OU-Filter module to the "System supply (in)" terminals of the OU-Fieldbus Coupler (0 V and 24 V).
- Connect the system supply (in) of the OU-Filter module to the power supply (0 V and 24 V).
- Connect the field supply (in) of the OU-Filter module to the power supply (0 V and 24 V resp. 0 V and 5 V).

i The system supply and field supply should be separated to ensure the bus operation and electrical isolation in case of a short-circuit of an actor.

8. System Requirements gapCONTROL Setup Software

- Windows 7 (32 bit and 64 bit, Windows 8 or 8.1 (32 bit and 64 bit)
- 1 GHz or faster (32 bit and 64 bit) processor / 1 GB RAM
- Screen resolution: 1024 x 768

i Only connect the sensor to the peripheral equipment, if it is disconnected from the power supply, i.e. only when the operating voltage is switched off. The sensor needs a warm-up time of typically 20 minutes for high precision measurements.

- Install the drivers for the measuring system according to the instructions on the supplied CD-ROM ([CD]:\Documentation\english\Installation\index.html).

10. Transmitting Measurement Results

gapCONTROL 2711 Firewire offers the following options for transmitting measurement results:

- Firewire Interface
 - Analog output of measurement values (via optional Output Unit)
 - Digital output of switching signals (via optional Output Unit)
- RS422 Interface
 - Modbus RTU protocol
 - Measurement value transmission in ASCII format

11. Driver Installation for Windows XP

Connect the sensor to the PC with the IEEE 1394 FireWire cable. If the driver installation does not start automatically, look in the device manager for the measurement system (Start > Control Panel > System > Hardware > Device Manager). You will find gapCONTROL either under „Imaging Devices“ or under "Other devices". Click with the right mouse button on the device and select "Update Driver..."

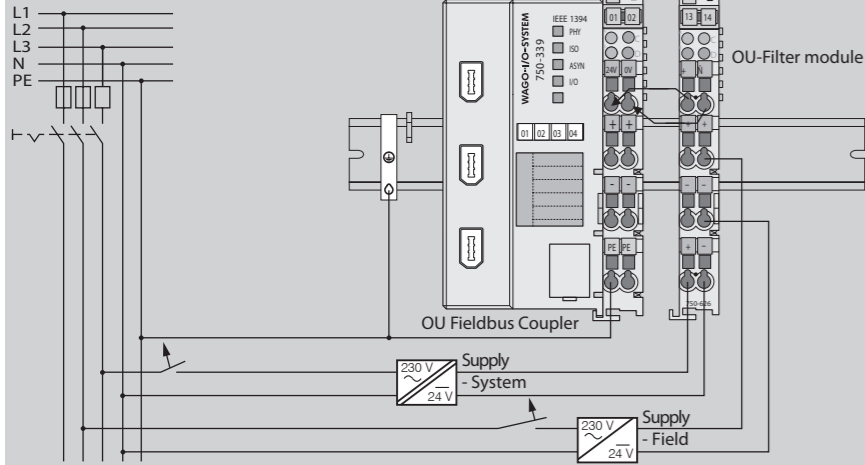

9. Quick Start: Commissioning, Software

- Install the software.

Please insert the gapCONTROL Setup Software CD in the CD-ROM device. Follow the dialog through the installation process.

A. Reading of installation help

B. Installation of software

C. Further informations in the online documentation

- Mount the sensor according to the installation instructions.

- Connect the sensor and the PC to the FireWire cable.

- Connect the sensor to display or monitoring units.

- Connect the sensor to the power supply.

The connectors for the operating voltage, switching signals and FireWire are fitted with push-pull locking. Pull apart at the grip to release the connection.

- Connect the shield of the power supply cable to the PE protective earth conductor of the main power supply. Close plug-in connections not needed with the supplied protective caps for ODU sockets. Switch on the power supply (24 VDC).