

Operating Instructions
optoNCDT 1320

ILD 1320-10

ILD 1320-500

ILD 1320-25

ILD 1320-50

ILD 1320-100

ILD 1320-200

Intelligent laser optical displacement measurement

MICRO-EPSILON
MESSTECHNIK
GmbH & Co. KG
Koenigbacher Str. 15

94496 Ortenburg / Germany

Tel. +49 (0) 8542 / 168-0
Fax +49 (0) 8542 / 168-90
e-mail info@micro-epsilon.com
www.micro-epsilon.com

Contents

1.	Safety	9
1.1	Symbols Used	9
1.2	Warnings	9
1.3	Notes on CE Marking	10
1.4	Notes on UKCA Marking	11
1.5	Intended Use	11
1.6	Proper Environment	11
2.	Laser Safety	12
3.	Functional Principle, Technical Data	14
3.1	Short Description	14
3.2	Auto Target Compensation (ATC)	15
3.3	Technical Data	16
4.	Delivery	18
4.1	Unpacking, Included in Delivery	18
4.2	Storage	18
4.3	Structure of the Serial Number	18
5.	Installation	19
5.1	Notes for Operation	19
5.1.1	Reflection Factor of the Target Surface	19
5.1.2	Error Influences	20
5.1.2.1	Light from other Sources	20
5.1.2.2	Color Differences	20
5.1.2.3	Temperature Influences	20
5.1.2.4	Mechanical Vibration	20
5.1.2.5	Movement Blurs	20
5.1.2.6	Surface Roughness	21
5.1.2.7	Angle Influences	22
5.1.3	Optimizing the Measuring Accuracy	23
5.2	Mounting, Dimensions	24
5.3	Indicator Elements at Sensor	26

5.4	Electrical Connections	27
5.4.1	Connection Possibilities	27
5.4.2	Pin Assignment.....	29
5.4.3	Supply Voltage	30
5.4.4	Laser on.....	30
5.4.5	RS422 Connection with USB Converter IF2001/USB	31
5.4.6	Analog Output	31
5.4.7	Multifunctional Input	32
5.4.8	Digital Output.....	33
5.4.9	Sensor Cable.....	34
6.	Operation	35
6.1	Getting Ready for Operation	35
6.2	Parameterizing via Web Interface	36
6.2.1	Preconditions.....	36
6.2.2	Access via Web Interface	37
6.2.3	Calibration Protocol.....	38
6.3	Presets, Setups, Measurement Configuration, Signal Quality.....	39
6.3.1	Measurement Presentation via Web Browser.....	41
6.3.2	Video Signal via Web Browser	43
6.4	Programming via ASCII Commands	45
6.5	Timing, Measurement Value Flux	45
7.	Set Sensor Parameter	46
7.1	Preliminary Remarks to the Adjustments	46
7.2	Overview Parameter.....	46
7.3	Inputs	47
7.4	Signal Processing.....	47
7.4.1	Preliminary Remark	47
7.4.2	Measurement Task	48
7.4.3	Measuring Rate	49
7.4.4	Triggering.....	50
7.4.4.1	General.....	50
7.4.4.2	Signal Processing - Value Output Trigger	52
7.4.5	Peak Selection.....	52
7.4.6	Error Handling	52
7.4.7	Zeroing and Mastering	53
7.4.7.1	Zeroing, Mastering with Select Key	54

	7.4.7.2	Zeroing, Mastering with Hardware Input	55
7.5	Outputs		56
	7.5.1	Overview	56
	7.5.2	Digital Output, RS422	57
	7.5.2.1	Values, Ranges	57
	7.5.2.2	Characteristics Digital Output	59
	7.5.3	Analog Output Scaling	61
	7.5.3.1	Output Scaling	61
	7.5.3.2	Output Scaling with Key Select	62
	7.5.3.3	Output Scaling via Hardware Input	63
	7.5.3.4	Calculation of Measuring Value using Analog Current	64
	7.5.3.5	Characteristics Distance Value and Analog Output	66
	7.5.3.6	Mastering and Teaching Analog Output	68
	7.5.4	Error Output	69
	7.5.5	Output Interface	70
7.6	System Settings		71
	7.6.1	General	71
	7.6.2	Unit, Language	71
	7.6.3	Keylock	71
	7.6.4	Load, Save	72
	7.6.5	Import, Export	74
	7.6.6	Access Authorization	75
	7.6.7	Sensor Reset	76
8.	Digital Interfaces RS422		77
8.1	Preliminary Remarks		77
8.2	Measurement Data Format		77
8.3	Conversion of the Binary Data Format		78
9.	Cleaning		79
10.	Software Support with MEDAQLib		79
11.	Disclaimer		80
12.	Service, Repair		80

13. Decommissioning, Disposal 81

Appendix

A 1	Optional Accessories.....	82
A 2	Factory Settings.....	84
A 3	ASCII Communication with Sensor.....	85
A 3.1	General.....	85
A 3.2	Overview Commands.....	87
A 3.3	General Commands.....	90
A 3.3.1	HELP.....	90
A 3.3.2	GETINFO, Sensor Information.....	90
A 3.3.3	LANGUAGE, Website.....	90
A 3.3.4	RESET, Boot Sensor.....	91
A 3.3.5	RESETCNT, Reset Counter.....	91
A 3.3.6	ECHO, Switching the Command Reply, ASCII Interface.....	91
A 3.3.7	PRINT, Sensor Settings.....	92
A 3.3.8	User Level.....	93
A 3.3.8.1	LOGIN, Change of the User Level.....	93
A 3.3.8.2	LOGOUT, Change into User Level.....	93
A 3.3.8.3	GETUSERLEVEL, User Level Request.....	93
A 3.3.8.4	STDUSER, Set Standard User.....	93
A 3.3.8.5	PASSWD, Change Password.....	93
A 3.3.9	Triggering.....	94
A 3.3.9.1	TRIGGER, Selection.....	94
A 3.3.9.2	MFILELEVEL, Input Pulse Multifunctional Input.....	94
A 3.3.9.3	TRIGGERCOUNT, Number of Displayed Measurement Values.....	94
A 3.3.9.4	TRIGGERSW, Software Trigger Pulse.....	94
A 3.3.10	Interfaces.....	95
A 3.3.10.1	BAUDRATE, RS422.....	95
A 3.3.10.2	UNIT, Web Interface.....	95
A 3.3.10.3	MFIFUNC, Function Selection Multifunctional Input.....	95
A 3.3.10.4	ERROROUT1, Activate Error Output.....	95
A 3.3.10.5	ERRORLEVELOUT1, Output Level Digital Output.....	96
A 3.3.10.6	ERRORLIMIT.....	96

	A 3.3.10.7 ERRORHYSTERESIS	96
	A 3.3.10.8 ERROROUTHOLD	96
A 3.3.11	Handling of Setups	97
	A 3.3.11.1 IMPORT	97
	A 3.3.11.2 EXPORT	97
	A 3.3.11.3 MEASSETTINGS, Load / Save Measurement Settings	97
	A 3.3.11.4 BASICSETTINGS, Load / Save Device Settings	98
	A 3.3.11.5 SETDEFAULT, Default Settings	98
A 3.3.12	ANALOGSCALE, Scaling the Analog Output	98
A 3.3.13	Key Function	99
	A 3.3.13.1 KEYFUNC, Choose Key Function	99
	A 3.3.13.2 KEYLOCK, Set Keylock	99
A 3.4	Measurement	99
	A 3.4.1 MEASPEAK, Choice of the Peak in the Video Signal	99
	A 3.4.2 MEASRATE, Measuring Rate	99
	A 3.4.3 LASERPOW, Laser Power	99
	A 3.4.4 Measurement Value Processing	100
	A 3.4.4.1 MASTERMV, Mastering / Zeroing	100
A 3.5	Data Output	100
	A 3.5.1 OUTPUT, Selection of Measurement Value Output	100
	A 3.5.2 OUTHOLD, Error Processing	100
	A 3.5.3 Selection of Measurement Values to be Output	101
	A 3.5.3.1 GETOUTINFO_RS422, Request Data Selection	101
	A 3.5.3.2 OUTADD_RS422, Selection of Data Additional Values	101
A 3.6	Example Command Sequence During Selection of Measurement Value	101
A 3.7	Error Messages	102
A 4	Control Menu	104
A 4.1	Tab Home	104
A 4.2	Tab Settings	104
	A 4.2.1 Inputs	104
	A 4.2.2 Signal Processing	105
	A 4.2.3 Outputs	107
	A 4.2.4 System Settings	109

1. Safety

Sensor operation assumes knowledge of the operating instructions.

1.1 Symbols Used

The following symbols are used in this operating instructions:



Indicates a hazardous situation which, if not avoided, may result in minor or moderate injury



Indicates a situation that may result in property damage if not avoided.



Indicates a user action.



Indicates a tip for users.

Measure

Indicates hardware or a software button/menu.

1.2 Warnings

Avoid unnecessary laser radiation to be exposed to the human body.

 Switch off the sensor for cleaning and maintenance.

 Switch off the sensor for system maintenance and repair if the sensor is integrated into a system.

Caution - use of controls or adjustments or performance of procedures other than those specified may cause harm.



Connect the power supply and the display/output device according to the safety regulations for electrical equipment.

> Risk of injury

> Damage to or destruction of the sensor

NOTICE

Avoid shocks and impacts to the sensor.
> Damage to or destruction of the sensor

Mount the sensor only to the existing holes on a flat surface. Clamps of any kind are not permitted.
> Damage to or destruction of the sensor

The supply voltage must not exceed the specified limits.
> Damage to or destruction of the sensor

Protect the sensor cable against damage. Attach the cable load-free, hold the cable after appr. 25 cm e.g. zip tie.
> Destruction of the sensor
> Failure of the measuring device

Avoid constant exposure of sensor to splashes of water.
> Damage to or destruction of the sensor

Avoid exposure of sensor to aggressive media (detergents, cooling emulsions).
> Damage to or destruction of the sensor

1.3 Notes on CE Marking

The following apply to the optoNCDT 1320:

- EU directive 2014/30/EU
- EU directive 2011/65/EU

Products which carry the CE mark satisfy the requirements of the EU directives cited and the relevant applicable harmonized European standards (EN). The sensor is designed for use in industrial environments.

The EU Declaration of Conformity and the technical documentation are available to the responsible authorities according to the EU Directives.

1.4 Notes on UKCA Marking

The following apply to the optoNCDT 1320:

- SI 2016 No. 1091:2016-11-16 The Electromagnetic Compatibility Regulations 2016
- SI 2012 No. 3032:2012-12-07 The Restriction of the Use of Certain Hazardous Substances in Electrical and Electronic Equipment Regulations 2012

Products which carry the UKCA mark satisfy the requirements of the directives cited and the relevant applicable standards. The sensor is designed for use in industrial environments.

The UKCA Declaration of Conformity and the technical documentation are available to the responsible authorities according to the UKCA Directives.

1.5 Intended Use

- The optoNCDT 1320 system is designed for use in industrial and laboratory applications.
- It is used
 - for measuring displacement, distance, position and thickness
 - for in-process quality control and dimensional testing
- The sensor must only be operated within the limits specified in the technical data, see [Chap.3.3](#).
- The sensor must be used in such a way that no persons are endangered or machines and other material goods are damaged in the event of malfunction or total failure of the controller.
- Take additional precautions for safety and damage prevention in case of safety-related applications.

1.6 Proper Environment

- Protection class: IP67 (applies only when the sensor cable is plugged in)

Lenses are excluded from protection class. Contamination of the lenses leads to impairment or failure of the function.

- Temperature range:
 - Operation: 0 °C ... +50 °C (+32 ... +104 °F)
 - Storage: -20 °C ... +70 °C (-4 ... +158 °F)
- Humidity: 5 ... 95 % RH (non-condensing)
- Ambient pressure: Atmospheric pressure

The protection class is limited to water (no penetrating liquids, detergents or similar aggressive media).

2. Laser Safety

The ILD1320 sensors operate with a semiconductor laser with a wavelength of 670 nm (visible/red).

The sensors fall within Laser Class 2. The laser is operated on a pulsed mode, the maximum optical power is ≤ 1 mW. The pulse frequency depends on the adjusted measuring rate (0.25 ... 4 kHz). The pulse duration of the peaks is regulated depending on the measuring rate and reflectivity of the target and can be 0.3 ... 3999.6 μ s.



Laser radiation. Irritation or injury of the eyes possible. Close your eyes or immediately turn away if the laser beam hits the eye.



Observe the national laser protection regulations.

Although the laser output is low, directly looking into the laser beam must be avoided.

Close your eyes or immediately turn away if the laser beam hits the eye. The housing of the optical sensors may only be opened by the manufacturer, see [Chap.11](#). For repair and service purposes the sensors must always be sent to the manufacturer.

Lasers of Class 2 are not subject to notification and a laser protection officer is not required.

The following warning labels are attached to the sensor cable.



Fig. 1 Laser labels on the sensor cable



Fig. 2 Laser warning sign on the sensor housing

During operation of the sensor, the pertinent regulations according to IEC 60825-1 on „Safety of laser products“ must be fully observed at all times. The sensor complies with all applicable laws for the manufacturer of laser devices.

Laser operation is indicated by LED, see Chap. 5.3.

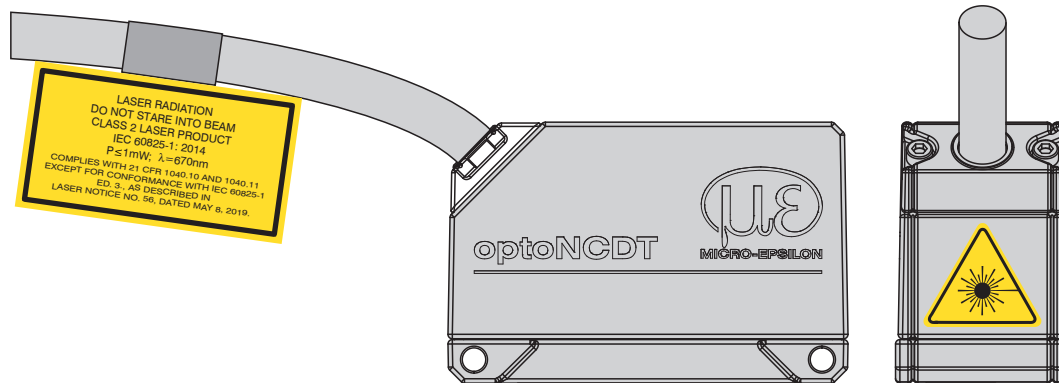

Fig. 3 Sensor cable and sensor with laser sign, ILD1320

i If both warning labels are covered over when the unit is installed, the user must ensure that supplementary labels are applied.

Please observe national regulations, e. g., Laser Notice No. 50 for the USA.

3. Functional Principle, Technical Data

3.1 Short Description

The optoNCDT 1320 uses the principle of optical triangulation, that is, a visible, modulated point of light is projected onto the target surface.

The diffuse part of the reflection of this point of light is displayed depending on distance on a position-resolving element (CMOS) by an receiver optic which is arranged to the optical axis of the laser beam in a defined angle.

A signal processor in the sensor calculates the distance of the point of light on the measuring object to the sensor by means of the output signal of the CMOS elements. The distance value is linearized and output by means of the analog or RS422 interface.

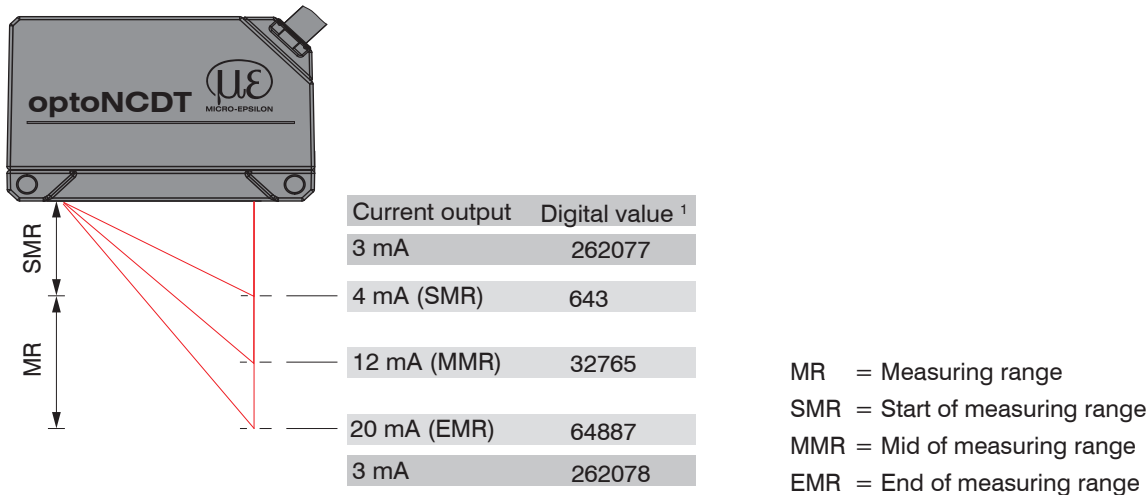

Fig. 4 Definition of terms

1) For distance values without zero setting or mastering only

3.2 Auto Target Compensation (ATC)

The Auto Target Compensation (ATC) enables stable compensation independent of color and brightness of the measuring object. Also small objects can be detected reliably thanks to the small measuring spot.

3.3 Technical Data

Model	ILD1320-10	ILD1320-25	ILD1320-50	ILD1320-100	ILD1320-200	ILD1320-500
Measuring range	10 mm	25 mm	50 mm	100 mm	200 mm	500 mm
Start of measuring range	20 mm	25 mm	35 mm	50 mm	60 mm	100 mm
Mid of measuring range	25 mm	37.5 mm	60 mm	100 mm	160 mm	350 mm
End of measuring range	30 mm	50 mm	85 mm	150 mm	260 mm	600 mm
Measuring rate ¹	5 adjustable stages: 4 kHz / 2 kHz / 1 kHz / 0.5 kHz / 0.25 kHz					
Linearity ²	< ±10 μm	< ±25 μm	< ±50 μm	< ±100 μm	< ±200 μm	< ±600 μm ... ±1200 μm
	< ±0.10 % FSO					< ±0,12 % ... ±0,24 % d.M
Repeatability ³	1 μm	2.5 μm	5 μm	10 μm	20 μm	50 μm
Temperature stability ⁴	±0.015 % FSO / K			±0.01 % FSO / K		
Light spot diameter ⁵ (±10 %)	SMR	90 x 120 μm	100 x 140 μm	90 x 120 μm	750 x 1100 μm	
	MMR	45 x 40 μm	120 x 130 μm	230 x 240 μm		
	EMR	140 x 160 μm	390 x 500 μm	630 x 820 μm		
	smallest ø	45 x 40 μm with 24 mm	55 x 50 μm with 31 mm	70 x 65 μm with 42 mm	-	
Light source	Semiconductor laser < 1 mW, 670 nm (red)					
Laser safety class	Class 2 in accordance with IEC 60825-1: 2014					
Permissible ambient light ⁶	30,000 lx			20,000 lx	7,500 lx	
Supply voltage	11 ... 30 VDC					
Power consumption	< 2 W (24 V)					
Signal input	1 x HTL laser on/off; 1 x HTL multifunction input: trigger in, zero setting, mastering, teach					
Digital interface ⁷	RS422 (16 bit) / EtherCAT / PROFINET / EtherNet/IP					
Analog output	4 ... 20 mA (16 bit; freely scalable within the measuring range)					

Switching output	1 x error output: npn, pnp, push pull	
Connection	integrated cable 3 m, open ends, minimum bending radius 30 mm (fixed installation)	
Mounting	Screw connection via two mounting holes	
Temperature range	Operation	0 ... +50 °C (non-condensing)
	Storage	-20 ... +70 °C (non-condensing)
Shock (DIN-EN 60068-2-29)	15 g / 6 ms in 3 axes, 1000 shocks each	
Vibration (DIN-EN 60068-2-6)	20 g / 20 ... 500 Hz in 3 axes, 2 directions and 10 cycles each	
Protection class (DIN-EN 60529)	IP67	
Material	Aluminium housing	
Weight	approx. 30 g (without cable), approx. 145 g (incl. cable)	
Control and display elements ⁸	Select button: zero, teach, factory setting; Web interface for setup with defined presets; 2 x color LEDs for power / status	

FSO = Full Scale Output

SMR = Start of measuring range, MMR = Mid of measuring range, EMR = End of measuring range

[1] Factory setting 1 kHz, modifying the factory setting requires the IF2001/USB converter (see accessories)

[2] FSO = Full Scale Output; the specified data apply to white, diffuse reflecting surfaces (Micro-Epsilon reference ceramic for ILD sensors)

[3] Measuring rate 1 kHz, median 9

[4] The specified value is only achieved by mounting on a metallic sensor holder. Good heat dissipation from the sensor to the holder must be ensured.

[5] $\pm 10\%$; SMR = Start of measuring range; MMR = Mid of measuring range; EMR = End of measuring range

[6] Illuminant: light bulb

[7] For EtherCAT, PROFINET and EtherNet/IP, connection via interface module is required (see accessories)

[8] Access to web interface requires connection to PC via IF2001/USB (see accessories)

4. Delivery

4.1 Unpacking, Included in Delivery

- 1 Sensor ILD 1320
- 1 Assembly instruction
- 1 Calibration protocol accessible via the web interface
- Accessories (2 pieces screw M2 and 2 pieces washer)

- ▶ Carefully remove the components of the measuring system from the packaging and ensure that the goods are forwarded in such a way that no damage can occur.
- ▶ Check the delivery for completeness and shipping damage immediately after unpacking.
- ▶ If there is damage or parts are missing, immediately contact the manufacturer or supplier.

Optional accessories are available in the appendix, see [Chap.A 1](#).

4.2 Storage

Temperature range storage: -20 ... +70 °C (-4 ... +158 °F)

Humidity: 5 ... 95 % RH (non-condensing)

4.3 Structure of the Serial Number

Sensors in a new design have an extended measuring rate, a higher resolution D/A converter and an improved protection class, see [Chap.3.3](#). They can be recognized by the serial number with the following structure:

- 10xxxxxx = ILD1320-10, ILD1320-25, ILD1320-50
- 40xxxxxx = ILD1320-100, ILD1320-200, ILD1320-500

Serial numbers for sensors with the old design can be recognized by the following structure:
JJMMxxxx (J = year, M = month)

5. Installation

5.1 Notes for Operation

5.1.1 Reflection Factor of the Target Surface

In principle the sensor evaluates the diffuse part of the reflected laser light.

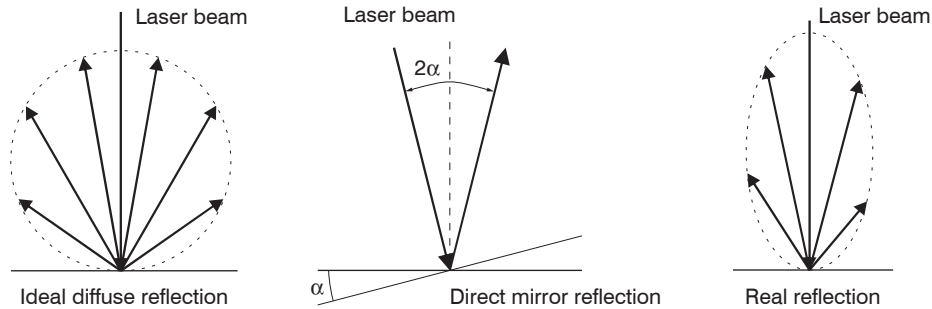

Fig. 5 Reflection factor of the target surface

A statement concerning a minimum reflectance is difficult to make because even a small diffuse fraction can be evaluated from highly reflecting surfaces. This is done by determining the intensity of the diffuse reflection from the CMOS signal in real time and subsequent compensation, see [Chap.3.2](#). Dark or shiny objects being measured, e.g. black rubber, may require longer exposure times. The exposure time is dependent on the measuring rate and can only be increased by reducing the sensor's measuring rate.

5.1.2 Error Influences

5.1.2.1 Light from other Sources

Thanks to their integrated optical interference filters the optoNCDT 1320 sensors offer outstanding performance in suppressing light from other sources. However, this does not preclude the possibility of interference from other light sources if the objects being measured are shiny and if lower measuring rates are selected. Should this be the case it is recommended to use suitable shields to screen the other light sources. This applies in particular to measurement work performed in close proximity to welding equipment.

5.1.2.2 Color Differences

Because of intensity compensation, color difference of targets affect the measuring result only slightly. However, such color differences are often combined with different penetration depths of the laser light into the material. Different penetration depths then result in apparent changes of the measuring spot size. Therefore color differences in combination with changes of penetration depth may lead to measuring errors.

5.1.2.3 Temperature Influences

When the sensor is commissioned a warm-up time of at least 20 minutes is required to achieve uniform temperature distribution in the sensor. If measurement is performed in the micron accuracy range, the effect of temperature fluctuations on the sensor holder must be considered. Due to the damping effect of the heat capacity of the sensor, sudden temperature changes are only measured with delay.

5.1.2.4 Mechanical Vibration

If the sensor is to be used for resolutions in the μm to sub- μm range, special care must be taken to ensure stable and vibration-free mounting of sensor and target.

5.1.2.5 Movement Blurs

If the objects being measured are fast moving and the measuring rate is low, it is possible that movement blurs may result. Always select a high measuring rate for high-speed operations, therefore, in order to prevent errors.

5.1.2.6 Surface Roughness

Laser-optical sensors detect the surface using an extremely small laser spot. They also track slight surface unevenness. In contrast, a tactile, mechanical measurement, e.g. using a caliper, detects a much larger area of the measurement object. In case of traversing measurements, surface roughnesses of $5\ \mu\text{m}$ and more lead to an apparent distance change.

Suitable parameters for the averaging number may improve the comparability of optical and mechanical measurements.

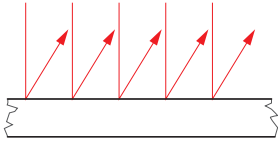

Ceramic reference surface

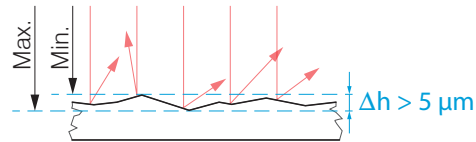

Structured surface

Recommendation for parameter choice:

The averaging number should be selected in such a way that a surface area the size of which is comparable to those with mechanical measurements is averaged.

5.1.2.7 Angle Influences

Tilt angles of the target in diffuse reflection both around the X and the Y axis of less than 5° only have a disturbing effect with surfaces which are highly reflecting.

These influences have to be explicitly considered when scanning profiled surfaces. Basically the angle behavior of triangulation is liable to the reflectivity of the measuring object surface.

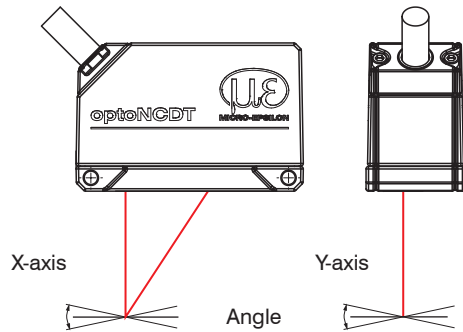
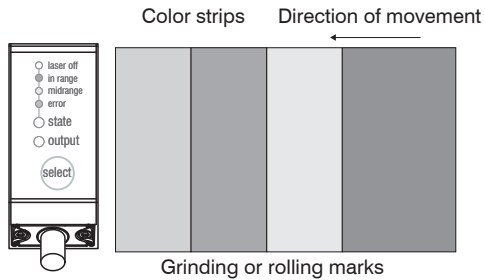

Fig. 6 Measurement errors through tilting with diffuse reflection

5.1.3 Optimizing the Measuring Accuracy



In case of rolled or polished metals that are moved past the sensor the sensor plane must be arranged in the direction of the rolling or grinding marks. The same arrangement must be used for color strips.

Fig. 7 Sensor arrangement in case of ground or striped surfaces

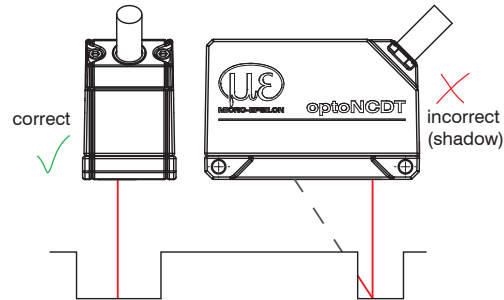

In case of bore holes, blind holes and edges in the surface of moving targets the sensor must be arranged in such a way that the edges do not obscure the laser spot.

Fig. 8 Sensor arrangement for holes and ridges

5.2 Mounting, Dimensions

The optoNCDT 1320 sensor is an optical system for measurements with micrometer accuracy. The laser beam must be directed perpendicularly onto the surface of the target. In case of misalignment it is possible that the measurement results will not always be accurate.

i Make sure it is handled carefully when installing and operating.

► Mount the sensor by means of 2 screws type M3 or by means of through bores for M2 with the screws from the accessories.

Bolt connection					Direct fastening			
								
Through length	Screw depth		Screw	Washer	Screw depth		Screw	Torque
	Minimum		ISO 4762-A2	ISO 7089-A2	$\mu = 0.12$			
mm	mm	2 pieces			Nm			
20	5.0	M2 x 25	A2.2	0.5				
	Minimum		ISO 4762-A2		Minimum	Maximum	ISO 4762-A2	$\mu = 0.12$
	mm	mm	2 pieces	Nm	mm	mm	M3	
					4.8	20		1.0

Fig. 9 Mounting conditions

The bearing surfaces surrounding the through-holes (mounting-holes) are slightly raised.

i Mount the sensor only to the existing holes on a flat surface. Clamps of any kind are not permitted. Do not exceed torques.

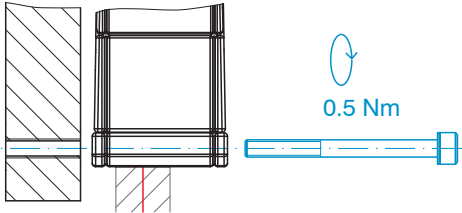
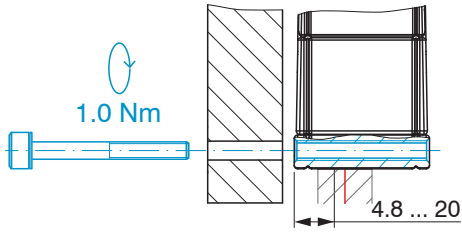
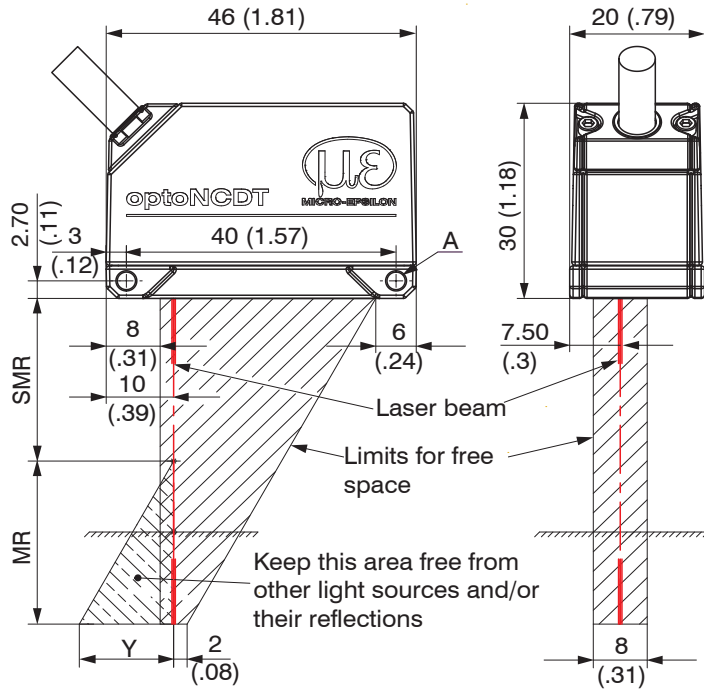

ILD 1320-		10	25	50	100	200	500
MR	mm	10	25	50	100	200	500
SMR	mm	20	25	35	50	60	100
EMR	mm	30	50	85	150	260	600
Y	mm	10	21	28	46	70	190

The indicated free space in the reception area has to be kept clear from foreign objects and extraneous light of other laser sensors at least until the end of measuring range.

- MR = Measuring range
- SMR = Start of measuring range
- MMR = Mid of measuring range
- EMR = End of measuring range
- FSO = Full scale output

Fig. 10 Dimensional drawing and free space for optics and optical free space

A: 2x M3 for direct fastening or
2x M2 for bolt connection

5.3 Indicator Elements at Sensor

LED State	Meaning
green	Measuring object within sensor range
yellow	Mid range
red	Error - e.g. Poor target or out of range
off	Laser off

LED Output	Meaning
green	RS422 measurement value output
yellow	The current output is switched off (output interface Web interface).
red	Current 4 ... 20 mA measurement value output
off	Sensor off, no supply

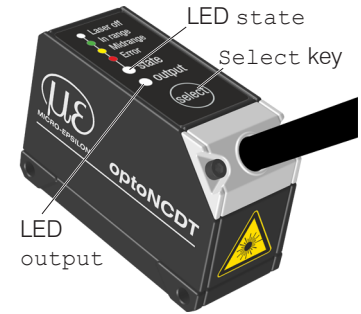

The programmable touch key `select` calls up the functions `Masters` and `Teaching`. By factory default this key is only active for the first 5 minutes after power up. After that it will be automatically locked. The keylock can be programmed via internal websites or ASCII commands.

5.4 Electrical Connections

5.4.1 Connection Possibilities

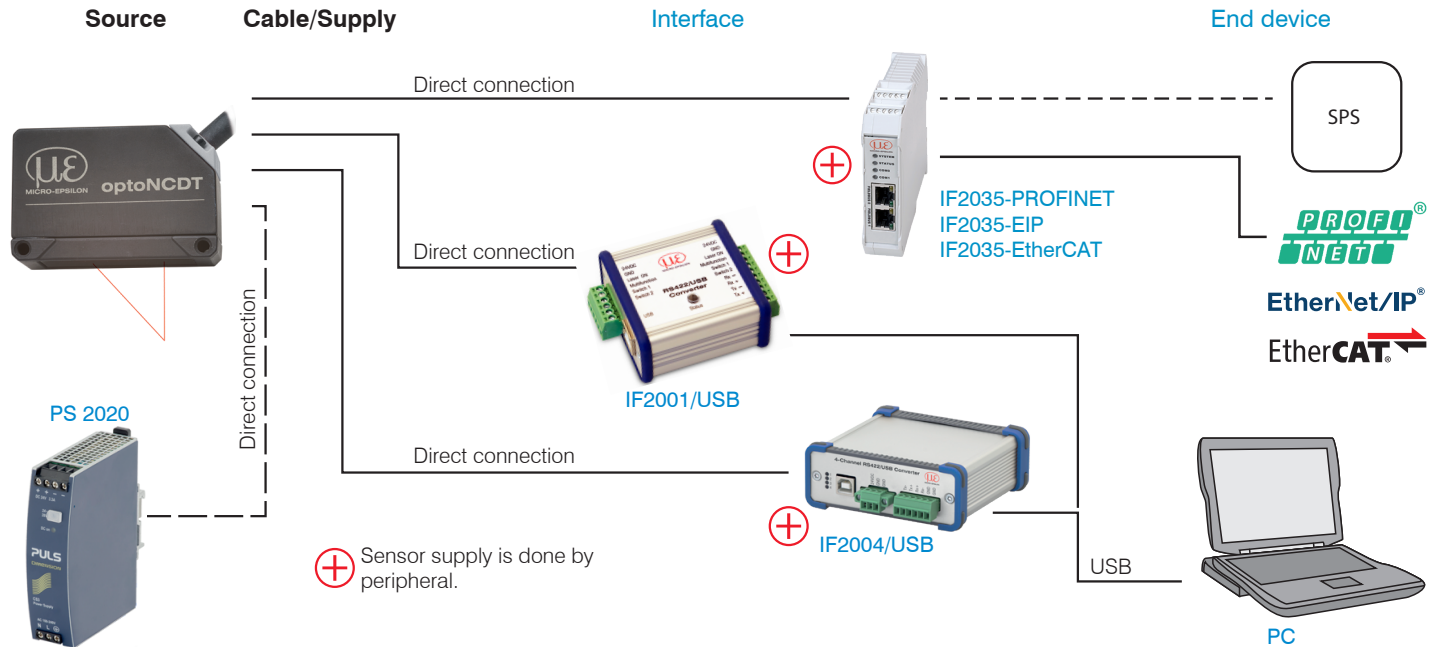

Fig. 11 Connection examples on ILD 1320

The different periphery devices can be connected to the sensor by the illustrated connections.

The converters IF2001/USB and IF2004/USB also supply the supply voltage (24 VDC) of the sensor. Power to the converters is supplied e. g. by the optional power supply PS 2020.

Peripheral	Sensor channels	Application / terminal device
IF2001/USB, RS422 USB converter	one	PC
IF2004/USB	one	PC
IF2035-PROFINET / -EIP / -EtherCAT	one	PLC
SPS, ILD 1320 or the like	---	Functional input: trigger
Switch, key, PLC or the like	---	Switching input laser On/Off

Fig. 12 Max. sensor channels on the peripheral devices

5.4.2 Pin Assignment

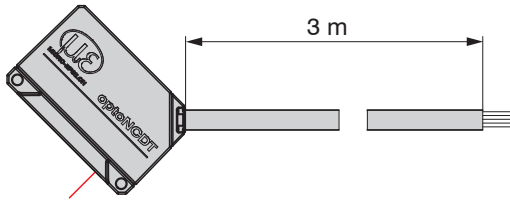

The shielding of the cable is connected to the sensor housing. The sensor cable is not cable carriers suitable. One end is molded on the sensor, the other end has free leads with ferrules.

ILD1320 with open ends

Signal	Color sensor cable	Description	Specification
RS422 Rx+	green	Serial input	Internally terminated with 120 Ohm
RS422 Rx-	yellow		
RS422 Tx+	gray	Serial output	Terminate externally with 120 Ohm
RS422 Tx-	pink		
+U _B	red	Supply voltage	11 ... 30 VDC, typ. 24 VDC, P < 2 W
Laser on/off	black	Switch input	Laser is active, if input is connected with GND
Functional input	violet		Trigger, Zero/Master, Teaching
Error	brown	Digital output	I _{max} = 100 mA, U _{max} = 30 VDC, Programmable switching characteristic: (NPN, PNP, Push-Pull)
I _{OUT}	white	4 ... 20 mA	R _{Load} = 250 Ohm: U _{OUT} 1 ... 5 V with U _B > 11 V R _{Load} = 500 Ohm: U _{OUT} 2 ... 10 V with U _B > 17 V
GND	blue	Ground potential	Supply and signal ground
Connector housing	Shield	Sensor housing	Connect with potential equalization

5.4.3 Supply Voltage

Nominal value: 24 VDC (11 ... 30 V, P < 2 W).

- Switch on the power supply unit once wiring is completed.
- Connect the inputs “red” and “blue” at the sensor with a 24 V supply voltage.

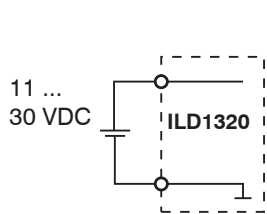

Wire color	Supply
red	+U _B
blue	Ground

Use the supply voltage for measurement instruments only and not for drive units or similar sources of pulse interference at the same time. MICRO-EPSILON recommends using an optional available power supply unit PS2020 for the sensor.

Fig. 13 Connection of supply voltage

5.4.4 Laser on

The measuring laser on the sensor is activated via an HTL switch input. This is advantageous if the sensor has to be switched off for maintenance or similar. Switching can be done with a transistor (for example open collector in an optocoupler) or a relay contact.

i If the black and blue wire are not connected, the laser is off.

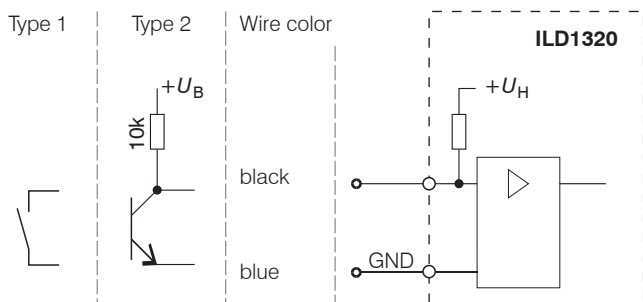

There is no external resistor for current limiting required. Connect the black wire with the blue wire for permanent „Laser on“.

Reaction Time for Laser-On: Correct measuring data are sent by the sensor approximately 1 ms after the laser was switched on.

Fig. 14 Electrical wiring for laser on

5.4.5 RS422 Connection with USB Converter IF2001/USB

i Disconnect or connect the D-sub connection between RS422 and USB converter when the sensor is disconnected from power supply only.

Sensor		End device (converter) Type IF2001/USB from MICRO-EPSILON
Signal	Sensor cable	
GND	blue	GND
Tx -	pink	Rx -
Tx +	grey	Rx +
Rx -	yellow	Tx -
Rx +	green	Tx +

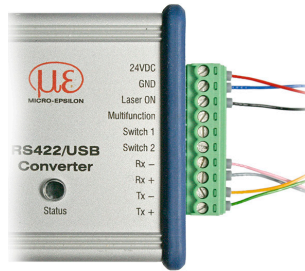

Symmetric differential signals acc. to EIA-422, not galvanically isolated from supply voltage.

Use a shielded cable with twisted cores.

Fig. 15 Pin assignment IF2001/USB

Cross the lines for connections between sensor and PC.

5.4.6 Analog Output

The sensor provides a current output 4 ... 20 mA.

i The output may not be continuously operated in short circuit operation without load resistor. The short circuit operation leads to durable thermal overload and thus for automatic overload shutdown of the output.

▶ Connect the white wire and the blue wire on the sensor to a measuring device.

Sensor	
Signal	Sensor cable
I_{OUT}	white
GND	blue

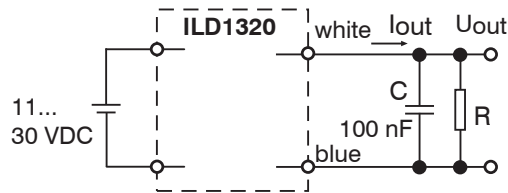

With the adjacent circuit you will get an analog voltage output in the range of 1 ... 5 V.

$R = 250 \text{ Ohm}$:

$U_{OUT} 1 \dots 5 \text{ V at } U_B > 11 \text{ V}$

$R = 500 \text{ Ohm}$:

$U_{OUT} 2 \dots 10 \text{ V at } U_B > 17 \text{ V}$

Fig. 16 Wiring for voltage output

5.4.7 Multifunctional Input

The multifunctional input enables the functions Triggering, Zeroing/Mastering, Teaching. The function is dependent on the programming of the input and of the time behavior of the input signal.

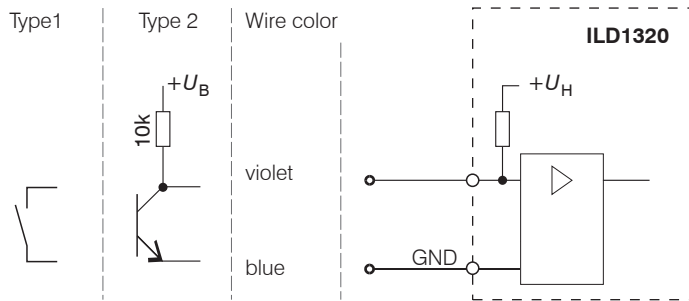

Fig. 17 Electrical wiring for multifunctional input

Input is not galvanically isolated.

24V logics (HTL):

Low level $\leq 2\text{ V}$

High level $\geq 8\text{ V}$ (max 30 V),

Internal pull up resistance, an open input is noticed as High.

Connect the input with GND to trigger the function.

5.4.8 Digital Output

The switching characteristic (NPN, PNP, Push-Pull, Push-Pull negated) of the digital output (Error) depends on the programming. The NPN output is e.g. suitable for adjustment to TTL logics with an auxiliary voltage $U_H = +5\text{ V}$. The digital output is protected against reverse polarity, overloading ($< 100\text{ mA}$) and over temperature.

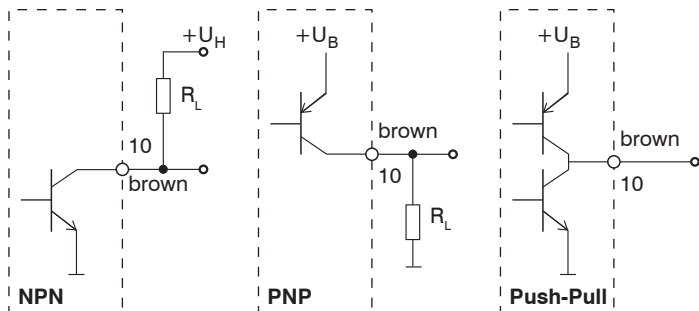

Output is not galvanically isolated.

24V logics (HTL),

$$I_{\max} = 100\text{ mA},$$

$$U_{H\max} = 30\text{ V saturation voltage at } I_{\max} = 100\text{ mA:}$$

Low $< 2.5\text{ V}$ (output - GND),

High $< 2.5\text{ V}$ (output - $+U_B$)

Fig. 18 Electrical wiring digital output

Switching characteristic		
Description	Output active (error)	Output passive (no error)
NPN (Low side)	GND	appr. $+U_H$
PNP (High side)	$+U_B$	appr. GND
Push-Pull	$+U_B$	GND
Push-Pull, negated	GND	$+U_B$

Fig. 19 Switching characteristic digital output

The digital output is activated when measuring object is missing, measuring object too close/too far or when no valid measurement value can be determined.

5.4.9 Sensor Cable

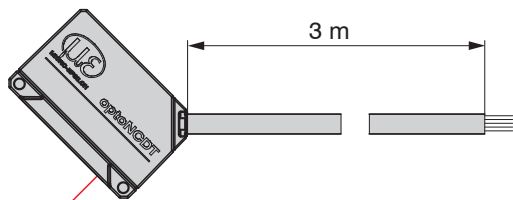

ILD 1320 with open ends

▶ Never fall below the bending radius for the sensor cable of 30 mm (fixed) or 60 mm (dynamic).

i The fixed connected sensor cables are not cable carriers suitable.

i Unused open cable ends must be insulated to protect against short circuits or malfunction of the sensor.

▶ Avoid excessive pulling to the cables. Provide strain relieves near the connectors when cables > 5 m are vertically free hanging.

▶ Connect the cable shield to the potential equalization (PE, protective earth conductor) on the evaluator (control cabinet, PC housing) and avoid ground loops.

▶ Never lay signal leads next to or together with power cables or pulse-loaded cables (e.g. for drive units and solenoid valves) in a bundle or in cable ducts. Always use separate ducts.

Recommended strand cross-section for self-made connection cables: $\geq 0.14 \text{ mm}^2$ (AWG 25).

6. Operation

6.1 Getting Ready for Operation

- ▶ Install and assemble the optoNCDT 1320 in accordance with the instructions set out, see [Chap.5](#).
- ▶ Connect the sensor with the indicator or monitoring unit and the power supply.

The laser diode in the sensor can only be activated if at the input Laser on/off Pin 8 is connected with Pin 12, see [Chap.5.4.4](#).

Once the supply voltage has been switched on the sensor runs through an initialization sequence. This is indicated by the momentary activation of all the LEDs. Once initialization has been completed, the sensor transmits a „->“ via the RS422 interface. The initialization takes up to 10 seconds. Within this period, the sensor executes the `Reset` or the `Bootloader` command through the key `select` only.

To be able to produce reproducible measurements the sensor typically requires a start-up time of 20 minutes.

If the LED `output` is off, this means that there is no supply voltage.

If the LED `state` is off, this means that the laser light source has been switched off.

6.2 Parameterizing via Web Interface

6.2.1 Preconditions

In the sensor a webserver is implemented. The web interface contains among other things the current settings of the sensor and the periphery. The operation is only possible as long as an RS422 connection to the sensor exists. The sensor is connected to a PC/notebook via a RS422 converter, supply voltage persist. sensorTOOL by MICRO-EPSILON is a piece of software that you can use to apply settings to the sensor and to view and document measurement data.

You can find it online at <https://www.micro-epsilon.com/download/software/sensorTOOL.exe>.

➤ Start the program SensorTool Vx.x.x.

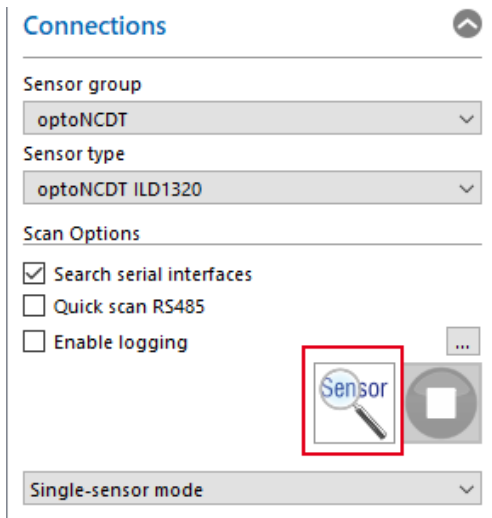

➤ Click the button **Sensor**.

The program searches for connected ILD1320 sensors on available interfaces.

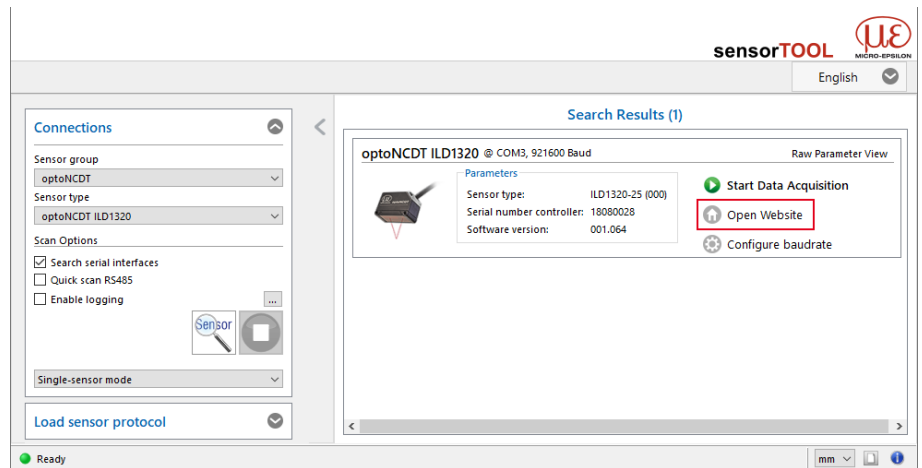

You need a web browser compatible with HTML5 on a PC/notebook.

➤ Choose the desired sensor. Click on the button **Open Website**.

Fig. 20 Auxiliary program for sensor search and to start web interface

6.2.2 Access via Web Interface

▶ Start the web interface of the sensor, see [Chap.6.2.1](#).

Interactive web pages you can use to configure the sensor are now displayed in the web browser. The sensor is active and supplies measurement values.



Fig. 21 First page after web interface has been accessed

The appearance of the websites can change dependent of the functions. Dynamic help text with excerpts from the operating instructions supports you during the sensor configuration.

i Depending on the selected measuring rate and the PC used, measured values may be reduced dynamically in the display. That is, not all measured values are transmitted to the web interface for display and saving.

The horizontal navigation includes the functions below:

- The search function permits time-saving access to functions and parameters.
- Home. The web interface automatically starts in this view with measurement chart, Configuration and Signal quality.
- Settings: This menu includes all sensor parameters, see [Chap.7](#).
- Measurement chart: Measurement chart with digital display or video signal display.
- Info: Includes information about the sensor, such as measuring range, serial number and software status.
- Web interface language selection

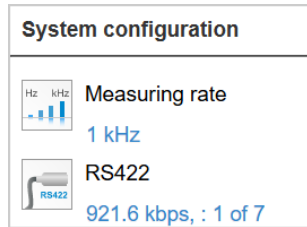

The area `System configuration` displays the current settings for measuring rate and RS422 in blue lettering.

Chart type



The area `Diagram type` enables the change between graphical display of the measurement value or the video signal.

6.2.3 Calibration Protocol

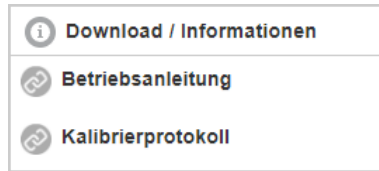

You can download the calibration protocol under `Download / Information` in the `Info` menu item.

6.3 Presets, Setups, Measurement Configuration, Signal Quality

Definition

- Preset: Manufacturer-specific program with settings for frequent measuring tasks; cannot be overwritten
- Setup: User-specific program with relevant settings for a measuring task
- Initial setup at boot (sensor start): a favorite can be selected from the setups, which is automatically activated at sensor start. If no favorite is determined from the setups, the sensor activates the Standard preset at startup.

With delivery of the sensor from the factory

- the presets Standard, Multi-Surface and Light penetration are possible
- no setup is available.

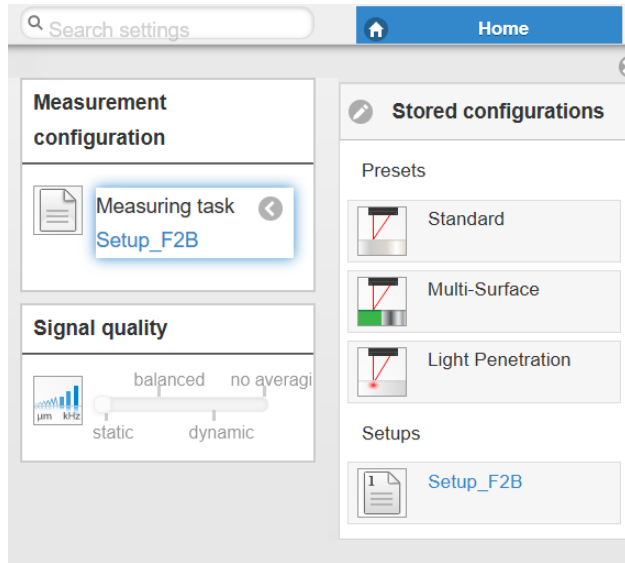

You can select a preset in the tab

Home > Measurement configuration

You can select a setup in the tab

Home > Measurement configuration or

Settings in menu System settings > Load & save

A setup can be stored permanently in the controller, see [Chap.7.6.4](#).

For all presets, the averaging can be individually adapted to the measuring task via the Signal quality slider.

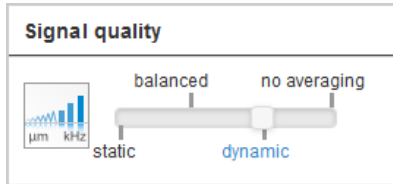

Averaging

- static
- moving, 128 values
- balanced
- moving, 64 values
- dynamic
- Median, 9 values
- no averaging

Description

In the area `Signal quality` you can switch between four given basic settings (static, balanced, dynamic and no averaging). You can instantly see the reaction in the diagram and system configuration.

Presets allow a quick start into the individual measuring task. Selecting a preset which is suitable for the target surface activates a predefined configuration of settings that will produce the best results for the material selected.

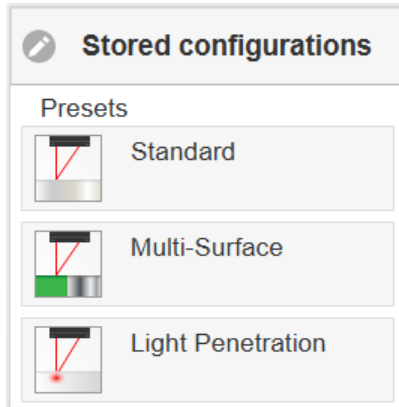

Standard

Ceramics, metall

Multi-Surface¹

Printed circuit boards (PCB), hybrid material

Light Penetration¹

Plastics (Teflon, POM), materials with large penetration depth of the laser

i After programming all the settings are to be stored permanently in a set of parameters. The next time you turn on the sensor they are available again. Therefore use the button `Save settings`.

1) Available for the sensor models ILD1320-10/25/50.
optoNCDT 1320

6.3.1 Measurement Presentation via Web Browser

▶ Start the measurement value display (Measurement chart) in the horizontal navigation bar.

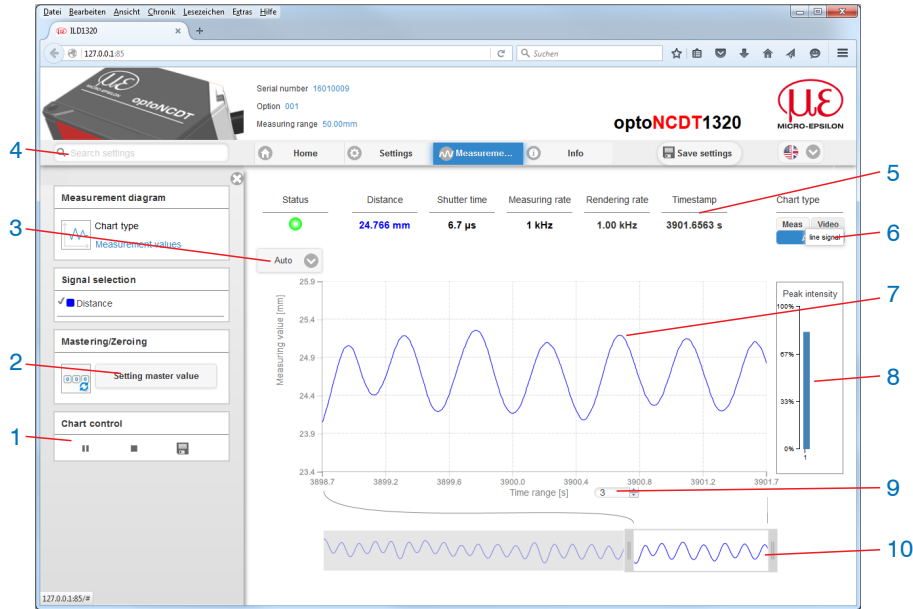

Fig. 22 Website measurement (distance measurement)

- 1 Stop stops the diagram; data selection and zoom function are still possible. Pause/Start interrupts or starts recording. Save opens the Windows selection dialog for file name and storage location to save the last 10,000 values in a CSV file (separation with semicolon).
- 2 This function starts or stops a relative measurement. The master value can also be defined in a submenu here.

- 3 For scaling the measurement value axis (y-axis) of the graphics you can either choose `Auto` (= autoscaling) or `Manual` (= manual setting).
- 4 The search function enables time-saving access to functions and parameters.
- 5 In the text boxes above the graphics current values for distance, exposure time, current measuring and display rate and time-stamp are displayed.
- 6 Choice of a diagram type. In the setting `Auto` the diagram type matching the setting is chosen automatically.
- 7 Mouse over function. When moving the mouse over the graphic in stopped state curve points are marked with a circle symbol and the related values are displayed in text boxes above the graphic. Peak intensity is also updated.
- 8 The peak intensity is displayed as bar chart.
- 9 Scaling of the x-axis can be defined by means of a input field below the time axis.
- 10 Scaling of the x-axis: you can enlarge (zoom) the overall signal by means of the left slider during ongoing measurement. If the diagram is stopped, you can also use the right slider. The zoom window can also be moved by means of the mouse in the middle of the zoom window (arrow cross).



If you leave the diagram display in a separate tab or window of the browser running, you do not have to restart the description each time.



Click the button `Start`, for starting the display of the measurement results.

6.3.2 Video Signal via Web Browser

▶ Start the video signal display with the function `Video` in the area `Diagram` type.

The diagram in the big graphic window on the right displays the video signal of the recipient filed. The video signal in the graphic window displays the intensity distribution above the pixels of the recipient field. 0 % (distance small) on the left and 100 % (distance big) on the right. The related measurement value is marked by means of a vertical line (peak marking).

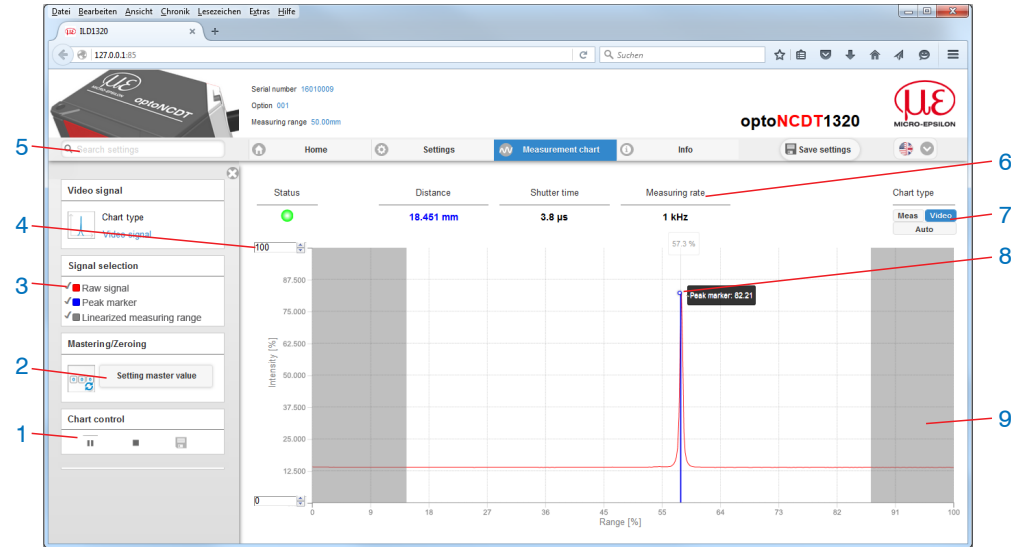

Fig. 23 Display of video signals

- 1 Stop stops the diagram; data selection and zoom function are still possible. Pause/Start interrupts or starts recording. Save opens the Windows selection dialog for file name and storage location to save the last 10,000 values in a CSV file (separation with semicolon).
- 2 This function starts or stops a relative measurement. The master value can also be defined in a submenu here.

- 3 The video curves to be displayed while or after measurement can be switched on or off in addition in the left window. Non active curves are highlighted in gray and can be added by clicking the hook. If you only want to see a single signal, then click on its name.
 - Raw signal (uncorrected CMOS signal, red)
 - Peak marking (vertical blue line), corresponds to the calculated measurement value
 - Linearized measuring range (limited by means of gray shading), cannot be changed
- 4 For scaling the measurement value axis (y-axis) of the graphics you can either choose `Auto` (= auto scaling) or `Manual` (= manual setting).
- 5 The search function enables time-saving access to functions and parameters.
 - ASCII commands to the sensor can also be sent via the search function.
- 6 In the text boxes above the graphics current values for distance, exposure time, current measuring and display rate and time-stamp are displayed.
- 7 Choice of a diagram type. In the setting `Auto` the diagram type matching the setting is chosen automatically.
- 8 Mouse over function. When moving the mouse over the graphic in stopped state curve points are marked with a circle symbol and the related intensity is displayed. The related x position in % appears above the graphic filed.
- 9 The linearized range is between the gray shading in the diagram and cannot be changed. Only peaks which centers are within this range can be calculated as measurement value. The masked range can be limited on request and is additionally limited by means of a light blue shading on the right and on the left. The remaining peaks in the resulting range are used for evaluation.

By displaying the video signal, you can detect effect of the adjustable measurement task (target material), choice of peak and possible interfering signals by means of reflections.

There is no linear relationship between the position of the peaks in the video signal and the output measurement value.

6.4 Programming via ASCII Commands

As an added feature you can program the sensor via an ASCII interface, physically the RS422.

This requires, that the sensor must be connected to a serial RS422 interface via a suitable interface converter, see [Chap.A 1](#), to a PC / PLC.

Pay attention in the programs used to the correct RS422 default setting.

Once connected, you can transmit the commands from the appendix, see [Chap.A 3](#), via the terminal to the sensor.

6.5 Timing, Measurement Value Flux

The sensor requires three cycles for measurement and calculation without triggering:

Each cycle takes $500 \mu\text{s}$ at a measuring rate of 2 kHz. The measured value N is available at the output after three cycles. The delay between acquisition and output is therefore $1500 \mu\text{s}$. As the processing in the cycles occurs parallel, after another $500 \mu\text{s}$, the next measured value (N+1) is output.

7. Set Sensor Parameter

7.1 Preliminary Remarks to the Adjustments

You can program the optoNCDT 1320 simultaneously in two different ways:

- using a web browser and the Web interface
- ASCII command set and a terminal program via RS422.



If you do not save the programming permanently in the sensor, you lost the settings after turning off the sensor.

7.2 Overview Parameter

The following parameters can be set or changed in the optoNCDT 1320, see tab *Settings*.

Inputs	Laser on/off, Multifunctional input, Key function
Signal processing	Measurement task, Measuring rate, Reset counter, Triggering (Data recording, Data output), Evaluation range (ROI), Peak selection, Error handling, Averaging, Zeroing/Mastering, Data reduction
Outputs	RS422, Analog output, Switching output
System settings	Unit on website, Keylock, Load & Store, Import & Export, Access authorization, Reset controller (factory settings)



Grey shaded fields require a selection.



Dark-bordered fields require you to specify a value.

7.3 Inputs

➡ Go to the menu `Inputs` in the menu `Settings`.

Laser on/off	<i>On / Off</i>		<i>Laser on/off is only effective when pin 8 is connected to GND.</i>
Multifunctional input	<i>Zeroing (Mastering)</i>	<i>High / Low</i>	<i>Sets the function of the switching input. The Trigger influences capture and export of a measurement value. Zeroing/Mastering sets the current measurement value to the entered master value. Teaching scales the analog output. HTL is defined as active input level.</i>
	<i>Trigger In</i>	<i>High / Low</i>	
	<i>Teaching</i>		
	<i>Inactive</i>		
Key function	<i>Zeroing (Mastering)</i>		<i>Sets the function of the sensor key. Inactive means keylock.</i>
	<i>Teaching</i>		
	<i>Inactive</i>		

7.4 Signal Processing

7.4.1 Preliminary Remark

➡ Go to the menu `Signal processing` in the tab `Settings`.

A diagram appears according to the prior settings in the area `Diagram type` in the right part of the display. The diagram is active and various settings can be seen immediately. You can find references to the chosen setting below.

The menus for the area `Signal processing` are located in the left part.

 Grey shaded fields require a selection.

 Value Dark-bordered fields require you to specify a value.

7.4.2 Measurement Task

The measurement task contains choice of the measuring object (target). The choice of a target loads a predefined sensor configuration which achieves the best results for the chosen material.

Measurement task	<i>Standard</i>	<i>Suitable for materials made of ceramics, metal or filled plastics</i>
	<i>Changing surfaces</i> ¹	<i>Suitable e.g. for Printed circuit boards (PCB) or hybrid materials</i>
	<i>Material with penetration</i> ¹	<i>Suitable for plastics (POM, Teflon), materials with large penetration depth of the laser</i>

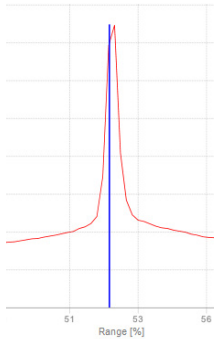

Setting: Standard

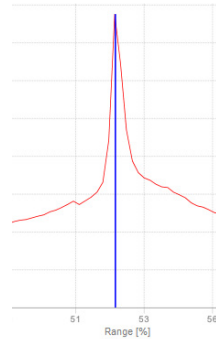

Material with penetration

The choice of measuring object preferences can be observed in the diagram `Video signal` on the right by means of the position of the blue peak marking in relation to the video signal (raw signal). It should preferably hit in the area of the highest point (peak) of the video signal.

In the setting `Standard` the peak marking (measurement value) of the plastics example POM does not hit the center of gravity of the real peak as its base is distorted asymmetrically by means of penetration of the laser light. This is possible only if the measurement task was set to `Material with penetration`.

Fig. 24 Example: Video signals (extract) with measuring object material POM

In the setting `Changing surfaces` a compromise between penetration and standard finish is chosen which achieves optimum results for both materials. This can also be seen in the diagram `distance values (Meas)` by means of the different distance values for the respective measurement tasks.

1) Available for the sensor models ILD1320-10/25/50.

 Grey shaded fields require a selection.

 Value Dark-bordered fields require you to specify a value.

7.4.3 Measuring Rate

The measuring rate indicates the amount of measurements per second.

 Choose the desired measuring rate.

Measuring rate	250 Hz / 500 Hz / 1 kHz / 2 kHz / 4 kHz	<i>Use a high measuring rate with light and matt measuring objects. Use a low measuring rate with dark and shiny measuring objects (e.g. black lacquered surfaces) to improve the measuring result.</i>
----------------	---	---

With a maximum measuring rate of 4 kHz the CMOS element is exposed 4,000 times per second. The lower the measuring rate, the higher maximum exposure time.

Measuring rate is set to 1 kHz ex works.

 Grey shaded fields require a selection.

 Value Dark-bordered fields require you to specify a value.

7.4.4 Triggering

7.4.4.1 General

The optoNCDT 1320 measurement output is controllable through an external trigger signal or a command. Triggering affects the analog and digital output. The measurement value at the time of triggering is output delayed, see [Chap.6.5](#).

- Triggering does not influence the timing so that between the trigger event (level change) and the start of output always lie 3 cycles + 1 cycle (Jitter).
- The multifunctional input is used as external trigger input, see [Chap.5.4.7](#).
- Factory setting: no triggering, the sensor starts data transmission right after start-up.
- Pulse duration of the “Trigger in” signal must be at least 50 μ s.

Output trigger	Level			A continuous measurement task is following as long as the chosen level remains the same. Choice of level, see Chap.7.3 . Pulse duration must be at least a cycle time. The following pause must be at least a cycle time..
	Edge	infinite		Edge selection. “0” end trigger, “1 ... 16382” values per trigger, “16383” endless trigger
		manual	Number	
	Software	infinite		A software triggering is started by clicking the button Release trigger. “0” end trigger, “1 ... 16382” values per trigger, “16383” endless trigger
		manual	Number	
Inactive			No triggering	

Valid with triggering:

$f_T < f_M$ f_T Trigger frequency

f_M Measuring rate

Grey shaded fields require a selection.

Value Dark-bordered fields require you to specify a value.

Implemented trigger conditions:

Level triggering with high level / low level.

Continuous measurement input or output, as long as the selected level is applied. Then stops the data output.

The pulse duration must be at least one cycle time. The subsequent break must also be at least one cycle time.

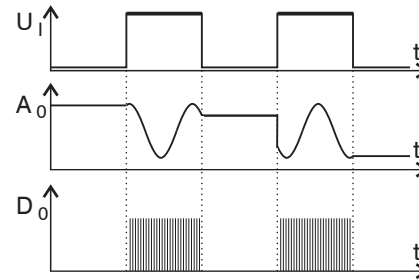

Fig. 25 High trigger level (above) with analog output A_0 and digital output signal D_0 (below)

Edge triggering with rising or falling edge.

Starts measured value acquisition or output as soon as the chosen edge is applied to the trigger input. The sensor outputs a fixed number of measurement values when trigger conditions have been met. Value range from 1 ... 16383. After termination of data output the analog output sticks to the last value (sample & hold).

Pulse duration must be at least 50 μ s.

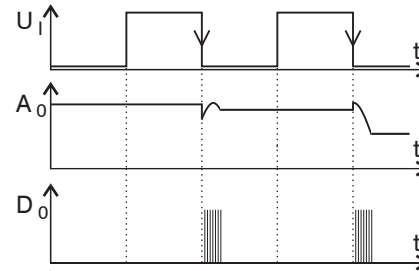

Fig. 26 Trigger edge HL (above) with analog output A_0 and digital output signal D_0 (below)

Software triggering. Starts the measurement value output, when a software command comes. The trigger time is defined more inaccurately. After the trigger event the sensor outputs the preset number of measurement values or starts a continuous measurement value output. If "0" is selected for the number of measurement values, the sensor stops the triggering and the continuous value output.

Measurement output can also be stopped by means of a command.

7.4.4.2 Signal Processing - Value Output Trigger

Measurement values are calculated continuously and independently of the trigger event. A trigger event simply triggers the value output via a digital interface. Therefore, any values measured immediately before the trigger event are included in calculating mean values (averages).

7.4.5 Peak Selection

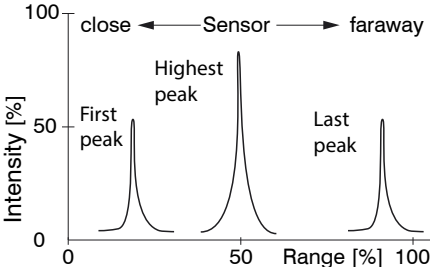
Peak selection	<i>First peak / highest peak / last peak</i>	<p><i>Defines, which signal is used for the evaluation in the line signal.</i></p> <p><i>First peak: nearest peak to the sensor.</i></p> <p><i>Highest peak: standard, peak with the highest intensity.</i></p> <p><i>Last Peak: widest peak to the sensor.</i></p>	
----------------	--	---	--

A correct measuring result can be determined only for the first peak when a measuring object which consists of several transparent layers.

7.4.6 Error Handling

Error handling adjusts the behavior of the analog output and the RS422 interface in the event of an error.

Error handling	<i>Error output, no value</i>	<i>Analog output supplies 3 mA instead of the measurement value. The RS422 interface outputs an error value.</i>	
	<i>Retain last value infinitely</i>	<i>Analog output and RS422 interface stick to the latest valid value.</i>	
	<i>Retain last value</i>	1 ... 1024	Value

If no valid measurement value can be detected, an error is output. If this disrupts further processing, you can alternatively hold the last valid value over a specific period of time i.e. it can be output again. After expiry of the chosen number an error value is output.

Grey shaded fields require a selection.

Value Dark-bordered fields require you to specify a value.

7.4.7 Zeroing and Mastering

By zeroing and mastering you can set the measurement value to a set point in the measuring range. The output range is moved thereby. This function makes sense, for example, for several adjacent measuring sensors or in the case of the thickness and planarity measurement.

Zeroing/ Mastering	Inactive		<i>Normal measurement value or Zeroing/Mastering is undone.</i>
	Active	Value	<i>Indication, e. g. of thickness of a master part. Value range max. 0 up to +2 x measuring range</i>

Setting masters is used to compensate mechanical tolerances in the measurement setup of the sensors or to adjust the temporal (thermal) changes in the measurement system. The masters measurement, also a known as the calibration measurement, is given a set point.

The value which is given during measurement on the sensor output of the “mastering object“ is the `master` value. The zero-setting is a characteristic of the mastering, because here the master value is 0.

When mastering the sensor’s characteristic is parallel displaced. The displacement of the characteristic curve reduces the usable measurement range of the sensor the further the master value is away from the master position.

Sequence for Mastering / Zeroing:

- ➡ Bring target and sensor in the desired position together.
- ➡ Send the master command.

The master command waits for 2 seconds on the next measurement value and masters it. If no measurement value is received within this time, for example by external triggering, the command returns with the error `E220 Timeout` back.

After the mastering, the sensor gives new measurement values, related to the master value. The non-mastered condition applies by means of a reset with the button `Inactive`.

- i** `Zeroing/Mastering` requires that a target is within the measurement range.
- `Zeroing/Mastering` has an influence on the digital and the analog output.

An invalid master value, e. g. no peak available, will be acknowledged with the `E602 Master value is out of range` error.

 Grey shaded fields require a selection.

 `Value` Dark-bordered fields require you to specify a value.

7.4.7.1 Zeroing, Mastering with Select Key

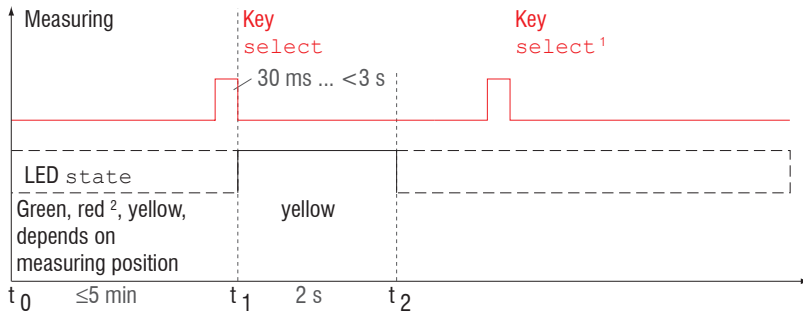

Fig. 27 Flow chart for zeroing, mastering (key select)

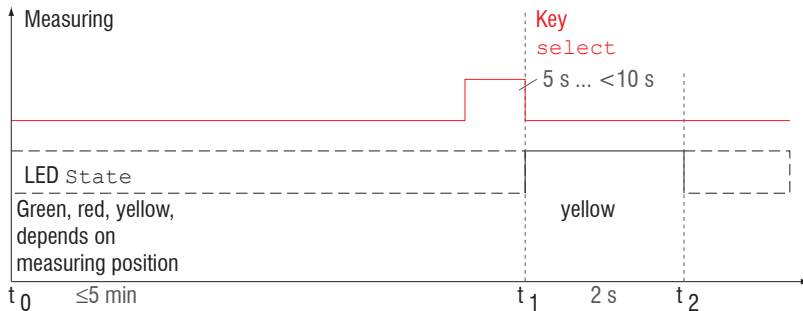

Fig. 28 Flow chart for the return of zero setting and mastering

- 1) The key `Select` remains without effect since key lock is active.
- 2) The master value is not applied when LED State is red, flash frequency 8 Hz for 2 s.

Grey shaded fields require a selection.

Value Dark-bordered fields require you to specify a value.

i The key `Select` is locked according to factory settings after expiry of 5 min. You can unlock the keylock e.g. via the web interface, see [Chap.7.6.3](#).

The function Zeroing/Mastering can be used several times in succession. Between repetition of the function Zeroing/Mastering a brake of 1 s is necessary. The function Zeroing/Mastering can also be combined with the multifunctional input.

7.4.7.2 Zeroing, Mastering with Hardware Input

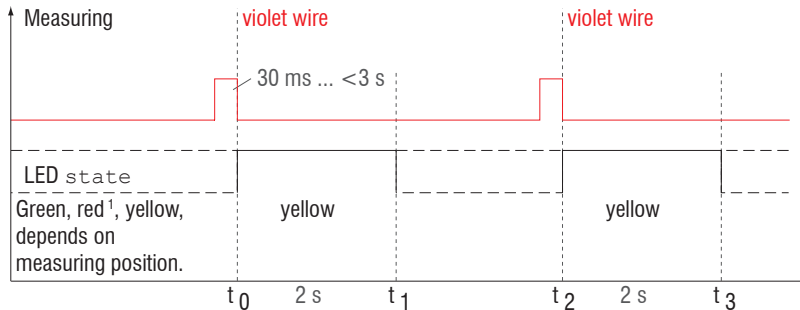

Fig. 29 Flow chart for zeroing, mastering (hardware input)

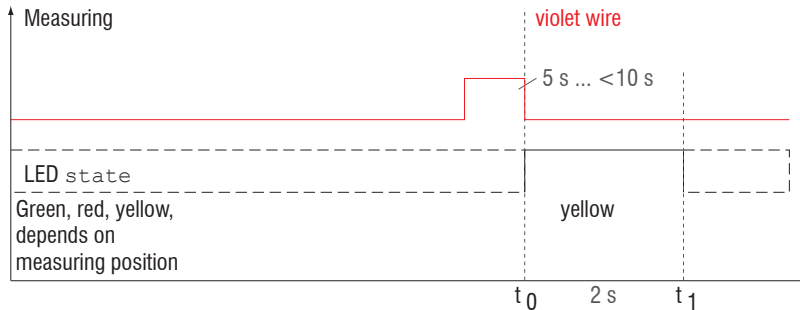

Fig. 30 Flow chart for the return of zero setting and mastering

The function zeroing/mastering can be applied successive in several times. Between repeating the zeroing/mastering function a pause of 1 s is required. The zeroing/mastering function can also be combined with the `select` key.

1) With red `State` LED, the master value is not accepted, flashes with 8 Hz for 2 s.

i A pulse can be made via the functional input (violet wire sensor cable). Details of the hardware input can be found in the electrical connections, see [Chap.5.4.7](#).

7.5 Outputs

7.5.1 Overview

RS422	Baud rate	9.6 / 19.2 / 56.0 / 115.2 / 230.4 ... / 1000 kBps		Transmission rate with binary data format.
	Output data	Distance / Shutter time / Intensity / Sensor state / Measurement counter / Non-linearized focal point / Time stamp / Video raw signal		The data which are provided for the transmission are to activate with the checkbox.
Analog output	Standard scale			Start of measuring range 4 mA, end of measuring range 20 mA
	Two-point scale	Minimum value	Value	Always 2 points which mark the start and end of a new measuring range are taught. Reversal of the output signal is possible with two-point scaling.
		Maximum value	Value	
Error output	Inactive			Adjusts the switching characteristic of the error output (error), see Chap.5.4.8 .
	Full scale error	NPN / PNP / PushPull / PushPullNeg		
Output Interface	Web interface / Analog / RS422			Decides via the used interface for measurement output. A parallel measurement output via multiple channels is not possible. When choosing web interface measurement values are not output via RS422 or current output.

7.5.2 Digital Output, RS422

7.5.2.1 Values, Ranges

The digital measuring values are being output as unsigned digital values (raw values). 16 or 18 bits per value are being transmitted. Subsequently you can find a compilation of output values and the conversion of the digital value.

Value	Length	Variables	Value range	Formula
Distance (without Mastering)	16 bits	x = digital value	[0; <643] SMR reserve [643; 64887] measuring range [>64887; 65520] EMR reserve	$d \text{ [mm]} = \frac{1}{100} \left(\frac{102}{65520} x - 1 \right) * \text{MR [mm]}$
		MR = measuring range [mm]	{10/25/50/100}	
		d = distance [mm]	[-0,01MR; 1,01MR]	
Distance (with Mastering)	18 bits	x = digital value	[0; 229320]	<p>The output range is also coded with 64235 values at 18 bit and shifted with the master value, see Fig. 33. The reserves at SMR and EMR are coded with 643 values each.</p> $d \text{ [mm]} = \frac{1}{100} \left(\frac{102}{65520} x - 51 \right) * \text{MR [mm]}$
		MR = measuring range [mm]	{10/25/50/100}	
		MP = master position [mm]	[0; MR]	
		MV = master value [mm]	[0; 2MR]	
		d = distance [mm]		
		MV < MP - 0.5MR:	[-0.5MR + MV; MR - MP + MV]	
MV ≥ MP - 0.5MR:	[-MP + MV; MR - MP + MV]			
Exposure time	18 bits	x = digital value	[1; 262143]	$\text{ET} \text{ [}\mu\text{s]} = \frac{1}{10} x$
		ET = exposure time [μs]	[0.1; 26214.3]	
Intensity	16 bits	x = digital value	[0; 65472]	$I \text{ [%]} = \frac{25}{16368} x$
		I = intensity [%]	[0; 100]	

Sensor status	18 bits	x = digital value	[0; 242143]	Bit 0 (LSB): peak starts before ROI
		Bit encoding	[0; 1]	Bit 1: peak ends after ROI
				Bit 2: no peak found
		SMR = Start of measuring range		Bit 5: distance before SMR (extended)
		EMR = End of measuring range		Bit 6: distance after EMR (extended)
				Bit 15: measuring value is triggered
				Bit 16, 17: status LED; - 00 – off 10 – red - 01 – green 11 – yellow
Measurement counter	18 bits	x = digital value	[0; 262143]	
Time stamp	2 words, at 16 bit	x = digital value Lo	[0; 65535]	$t \text{ [ms]} = \frac{1}{100} (65536y + x)$
		y = digital value Hi	[0; 65535]	
		t = time stamp [ms]	[0; 11h55m49.67s]	
Non-linearized center of gravity	18 bits	x = digital value	[0; 262143]	$CG \text{ [%]} = \frac{100}{262143} x$
		CG = center of gravity	[0; 100]	
Video raw signal	16 bits	512 pixel	[0; 65535]	

Additional information transmitted in the distance value

Distance value	Description
262075	data amount to big for selected baud rate
262076	no peak available
262077	peak before the measurement range (MR)
262078	peak behind the measurement range (MR)
262080	measurement can not be evaluated, global error
262081	peak is to large
262082	Laser is off

7.5.2.2 Characteristics Digital Output

Measurements are coded with 18 bit, if the based on zero setting or mastering. The master value itself can accept the double measuring range. The examples below show the digital output behavior of an ILD1320-50 with 50 mm measuring range.

Target at 16 % measuring range

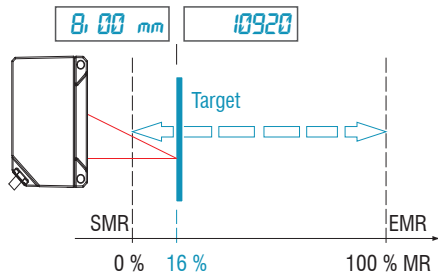

Target at 60 % measuring range

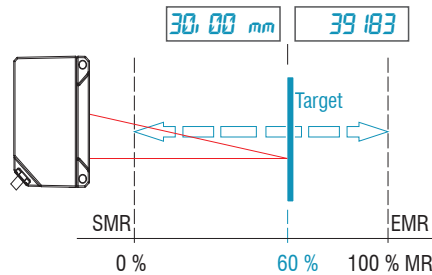

Target at 60 % measuring range

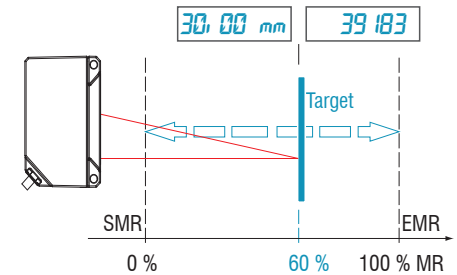

➡ Zero setting (master value = 0 mm)

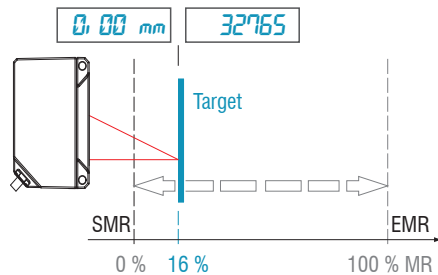

➡ Zero setting (master value = 0 mm)

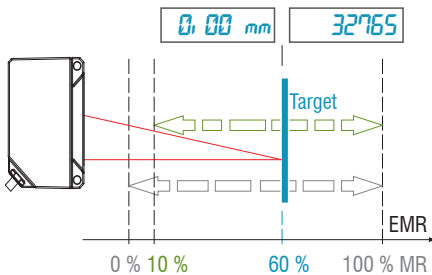

➡ Set master value 10 mm

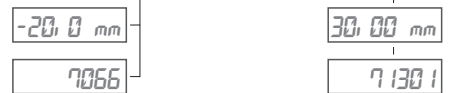
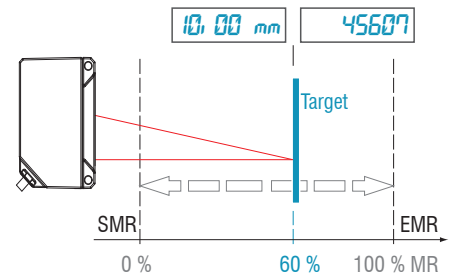

Digital minimum reached at 10 % MR

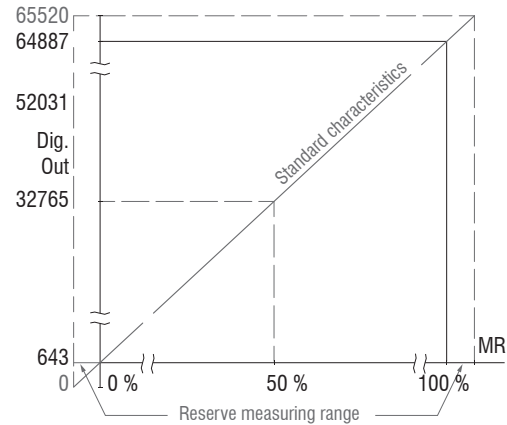

Fig. 31 Digital values without zero setting or mastering

➡ Set target at 80 % measuring range (40 mm), set master value 100 mm

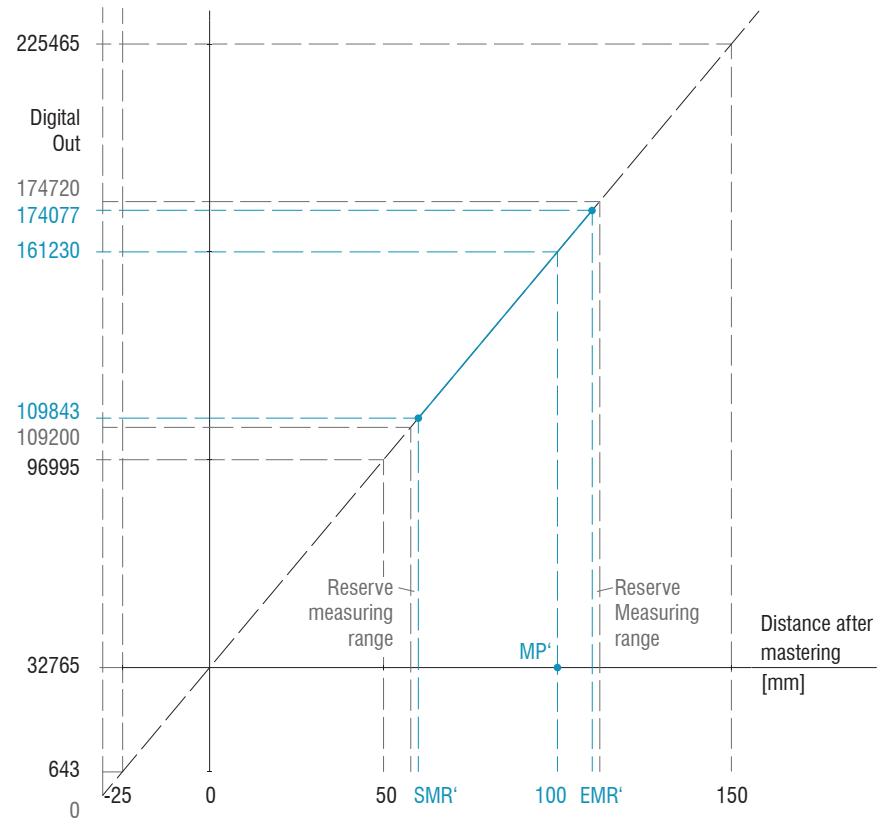

Fig. 32 Digital values of an ILD1320-50 with mastering, master value 100 mm

7.5.3 Analog Output Scaling

7.5.3.1 Output Scaling

- Max. output range: 4 mA ... 20 mA
- Output gain ΔI_{OUT} : 16 mA = 100 % MR
- Error value: 3.0 mA ($\pm 10 \mu\text{A}$)

The teaching scales the analog output (4 to 20 mA) for a part of the measuring range. This allows you to optimize the resolution for the analog measurement range. Only the current and switching output will be affected by the 2 point calibration. Therefore you define a new start and end for the measurement range. This teaching procedure can be performed live via the `select` key, the multifunctional `input` or via the webinterface.

i With a user defined output scaling you can use the error output, see [Chap.5.4.8](#), as a programmable limit switch.

The measurement object positions for `Teach 1` and `Teach 2` have to differ from each other.

The teaching process requires a valid measuring signal. The teaching process is terminated at

- no target,
- target not evaluated,
- to close to the sensor - beyond SMR
- to far from the sensor - beyond EMR.

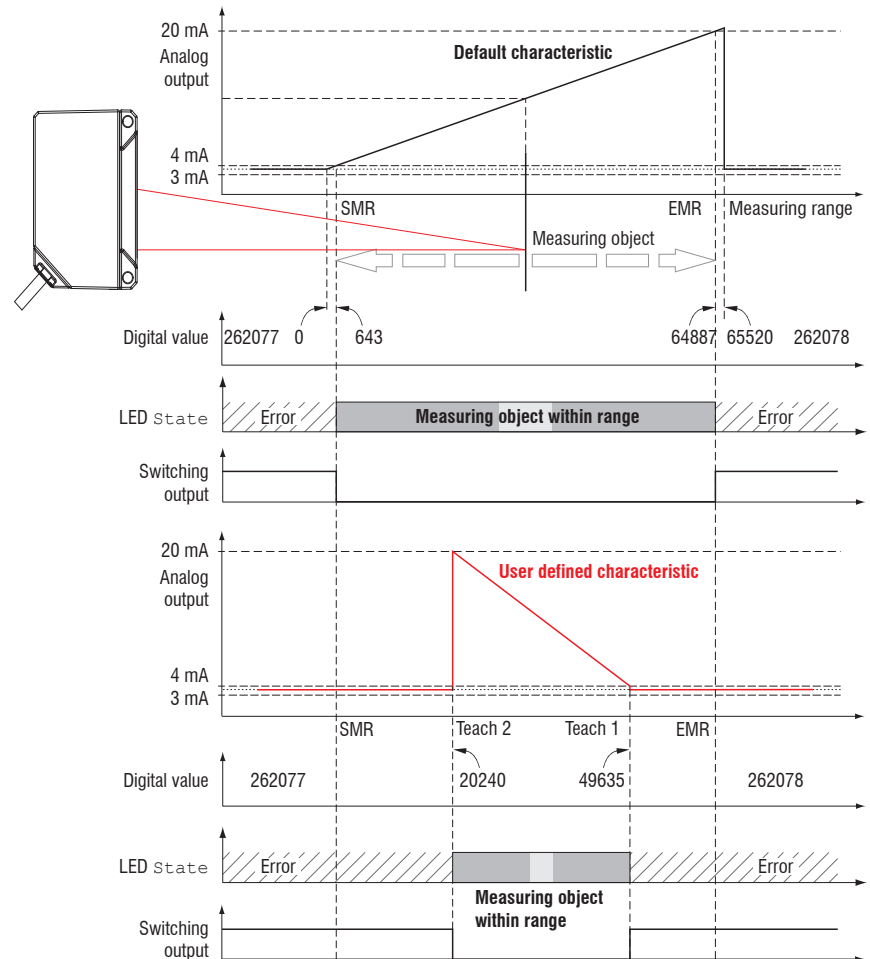

Fig. 33 Default characteristic (black), reverse, user defined characteristic (red)

7.5.3.2 Output Scaling with Key Select

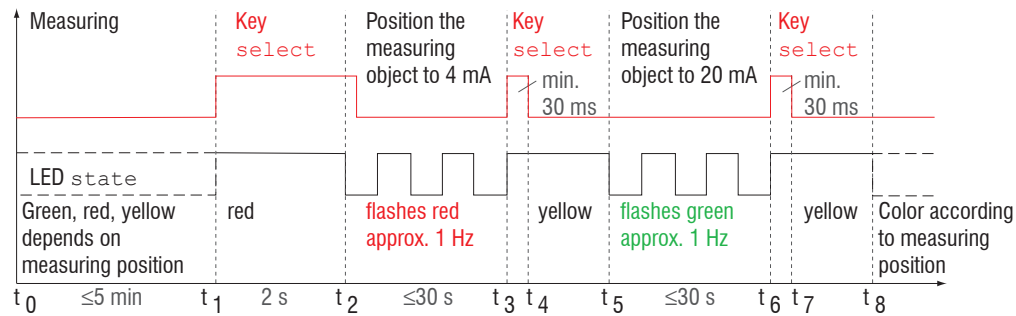

Fig. 34 Flow chart for output scaling

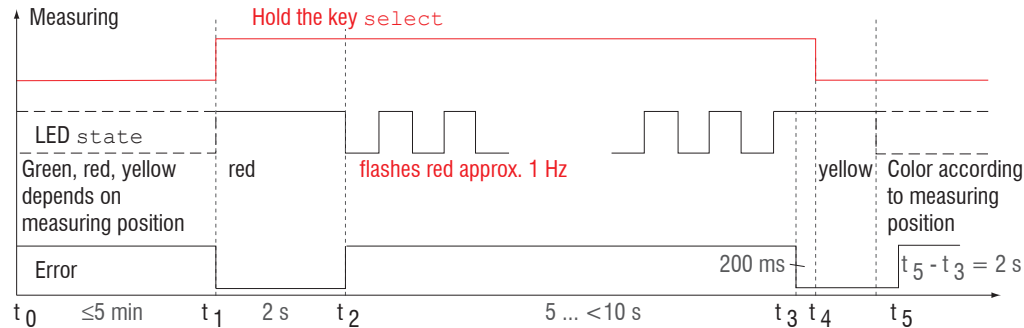

Fig. 35 Flow chart for the return of output scaling

If the key Select is pressed longer than 10 s or not within the timeframe while doing the return of the output scaling, an error is shown via State LED. In this case the State LED is blinking red with 8 Hz for 2 s.

7.5.3.3 Output Scaling via Hardware Input

Scaling of the analog output can be made via an impulse at the functional input, the violet wire on the sensor cable.

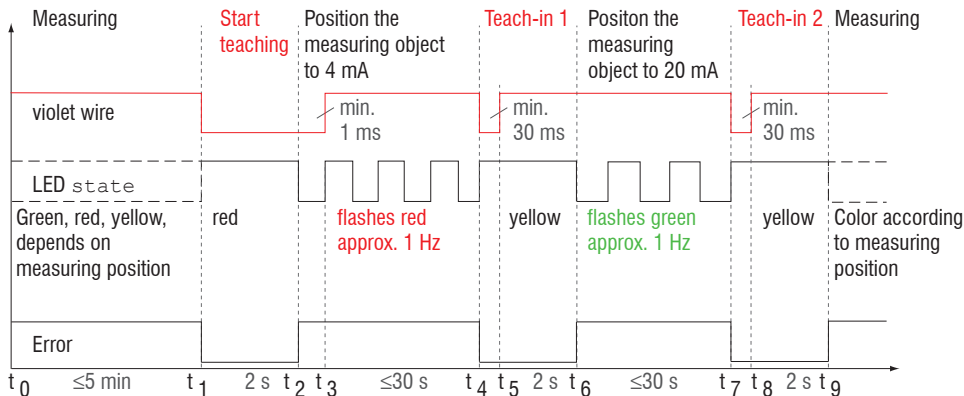

Fig. 36 Flow chart for output scaling

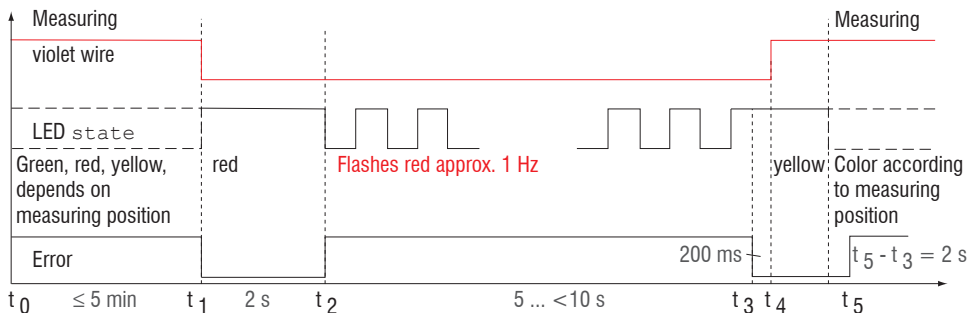

Fig. 37 Flow chart for the return of output scaling

7.5.3.4 Calculation of Measuring Value using Analog Current

Current output (without mastering, without teaching)

Variables	Value range	Formula
I_{OUT} = current [mA]	[3,8; <4] SMR reserve [4; 20] measuring range [>20; 20,2] EMR reserve	$d \text{ [mm]} = \frac{(I_{OUT} \text{ [mA]} - 4)}{16} * MR \text{ [mm]}$
MR = measuring range [mm]	{10/25/50/100}	
d = distance [mm]	[-0,01MR; 1,01MR]	

Current output (with mastering), reference value is midrange

Variables	Value range	Formula
I_{OUT} = current [mA]	[3,8; <4] SMR reserve [4; 20] measuring range [>20; 20,2] EMR reserve	$d \text{ [mm]} = \frac{(I_{OUT} \text{ [mA]} - 12)}{16} * MR \text{ [mm]}$
MR = measuring range [mm]	{10/25/50/100}	
MP = master position [mm]	[0; MR]	
d = distance [mm]	for $MP \leq 0.5MR$: [-MP; 0.5MR] for $MP > 0.5MR$: [-0.5MR; MR - MP]	

Current output (with teaching)

Variables	Value range	Formula
I_{OUT} = current [mA]	[3,8; <4] SMR reserve [4; 20] measuring range [>20; 20,2] EMR reserve	$d \text{ [mm]} = \frac{(I_{OUT} \text{ [mA]} - 4)}{16} * n \text{ [mm]} - m \text{ [mm]} $
MR = measuring range [mm]	{10/25/50/100}	
m, n = teachig area [mm]	[0; MR]	
d = distance [mm]	[m; n]	

Current output (with mastering and teaching)

Variables	Value range	Formula
I_{OUT} = current [mA]	[3,8; <4] SMR reserve [4; 20] measuring range [>20; 20,2] EMR reserve	$d \text{ [mm]} = \frac{(I_{OUT} \text{ [mA]} - 12)}{16} * n \text{ [mm]} - m \text{ [mm]} $
MR = measuring range [mm]	{10/25/50/100}	
MP = position object [mm]	[0; MR]	
m, n = teaching area [mm]	for $MP \leq 0.5MR$: [-MP; 0.5MR]	
	for $MP > 0.5MR$: [-0,5MR; MR - MP]	
d = distance [mm]	[m; n]	

7.5.3.5 Characteristics Distance Value and Analog Output

The mastering and zero setting function set the analog output on half of the output range independent on the master value, thus 12 mA. The examples below show the current output and the distance value behavior of an ILD1320-50 with 50 mm measuring range.

Target at 16 % measuring range

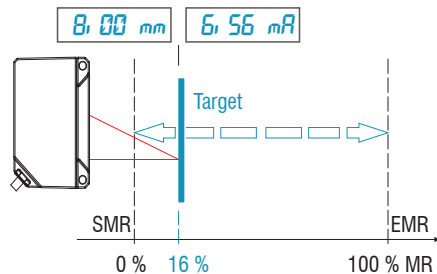
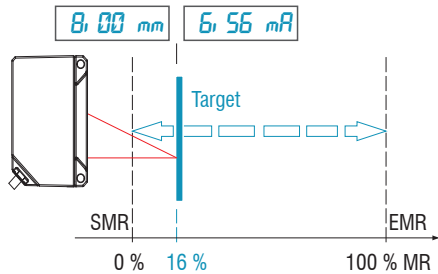

Target at 60 % measuring range

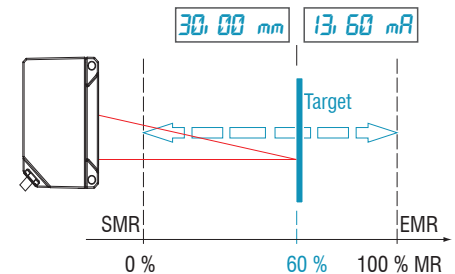

➡ Zero setting (master value = 0 mm)

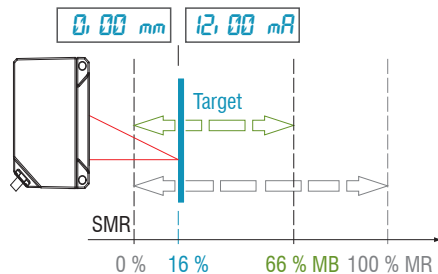

➡ Set master value 5 mm

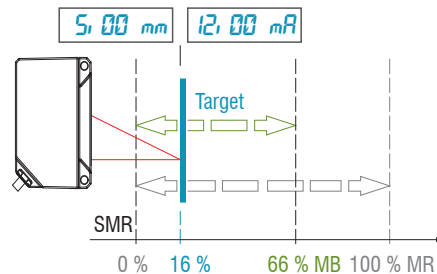

➡ Set master value 10 mm

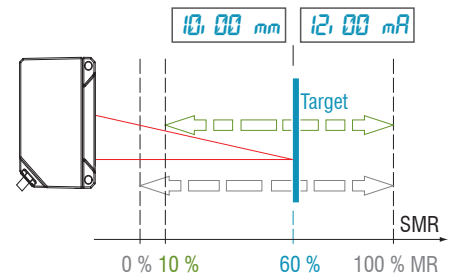

Analog maximum reached at 66 % MR

Analog minimum reached at 10 % MR

MR = measuring range, SMR = start of measuring range, EMR = end of measuring range

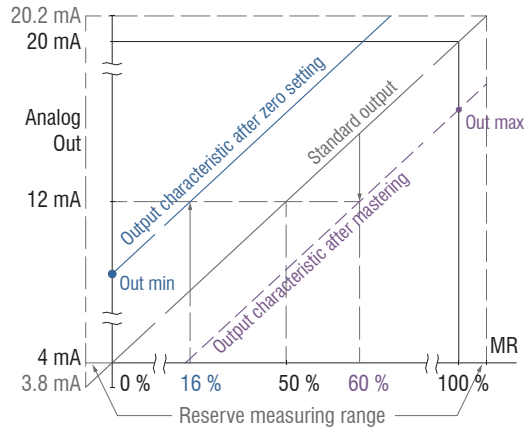

Master point	Master value	Out min	Out max
16 % (8 mm)	0 mm	9.44 mA (-8 mm)	20.0 mA (33 mm)
60 % (30 mm)	10 mm	4.00 mA (-15 mm)	18.40 mA (30 mm)

Fig. 38 Analog output with zero setting or mastering

7.5.3.6 Mastering and Teaching Analog Output

Proceed as follows:

1. Mastering or zero setting, menu `signal processing`
2. Teach putput, menu `Outputs`

The mastering and zero setting function set the analog output on half of the output range, see [Chap.7.5.3.5](#).

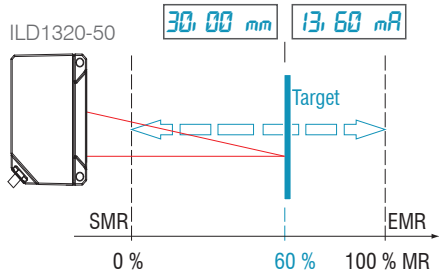

- ➡ Target at 60 %, set master value 0 mm
- ➡ Set minimum (m) 20 mm and maximum (n) 40 mm

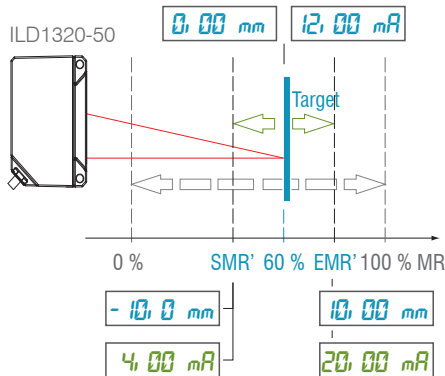

i With $n < m$ generates an inverse characteristic.

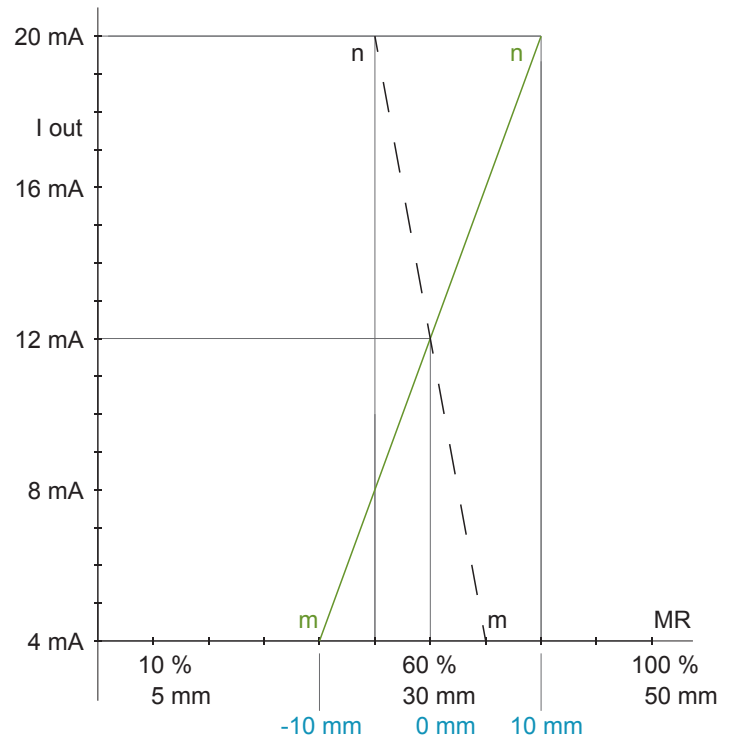

Fig. 39 Analog output characteristic after mastering and scaling with an ILD1320-50

7.5.4 Error Output

The switching output can be used for error or limit value monitoring of the output value.

error output (Digital output)	<i>Inactive</i>		<i>Regulates the switching performance of the digital output (Error), see Chap.5.4.8. Analog range: digital output switches when the scaled analog range is exceeded. Measuring range: The digital output is switched when the peak is not (entirely) in evaluation range (ROI), e. g. target outside the measuring range, target is absent. Limit monitoring: digital output switches when the limit is exceeded.</i>	
	<i>Analog range / Measuring range</i>	<i>NPN / PNP / PushPull / PushPullNeg</i>		
	<i>Limit monitoring</i>	<i>NPN / PNP / PushPull / PushPullNeg</i>		
		<i>Limit</i>		<i>Value</i>
		<i>Hysteresis</i>		<i>Value</i>
	<i>Minimum holding period</i>	<i>Value</i>		

The switching output is activated depending on the set switching behavior, see [Chap.5.4.8](#).

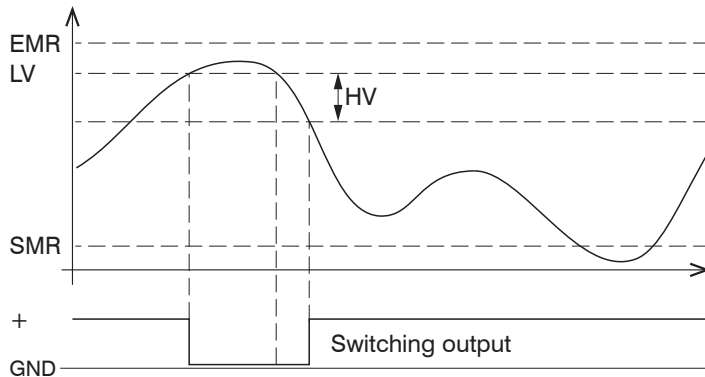

When exceeding the limit value, the switching output is activated (conductive) and is then deactivated again when the next hysteresis value is not reached.

The switching output with function `measuring range` or `limit monitoring` is independent of the analog output.

EMR = End of measuring range
 LV = Limit value
 HV = Hysteresis value
 SMR = Start of measuring range

Fig. 40 Switching output with function limit value, switching behavior (NPN)

Grey shaded fields require a selection.

Value Dark-bordered fields require you to specify a value.

7.5.5 Output Interface

The data output selects the used interface of the sensor for data transmission.

		LED Output	Web interface		Current output	Digital output
			Parametrization	Measurement chart		
Selected output interface	Web interface	yellow	yes	yes		
	Analog (factory setting)	red	possible	possible	yes	
	RS422	green	possible			yes

Fig. 41 Options for data output

Output interface	<i>Web interface / Analog / RS422</i>	<i>Decides on the used interface for measurement value output. A parallel physical measurement value output via RS422 and analog is not possible. If web interface was selected, no measurement values are output via RS422 or current output.</i>
------------------	---------------------------------------	--

 Grey shaded fields require a selection.

 Value Dark-bordered fields require you to specify a value.

7.6 System Settings

7.6.1 General

After programming all the settings are to be stored permanently in a set of parameters. The next time you turn on the sensor they are available again.

7.6.2 Unit, Language

The web interface promotes the units millimeter (mm) and inch when displaying measuring results.

You can choose German, English, Chinese or Japanese in the web interface. You can change language in the menu bar.

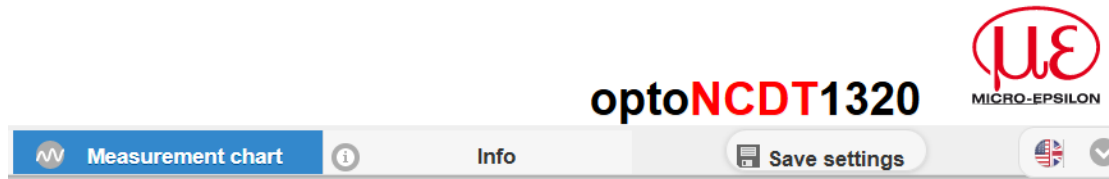



Fig. 42 Language selection in the menu bar

7.6.3 Keylock

The function keylock for the key *Select*, see [Chap.5.3](#), prevents unauthorized / unintended performing of the key functions. Keylock is always activated when user level *User* is chosen. Keylock can only be deactivated in user level *Expert*. If an expert logs in the system, keylock on the sensor is automatically unlocked.

Key lock	Automatic	Range from 1 ... 60 [min]	Value	Keylock starts after expiry of defined time. Clicking the button <i>Refresh</i> prolongs the timeframe until keylock starts.
	Active			The key <i>Select</i> is deactivated independent of the user level.
	Inactive			The key <i>Select</i> is active independent of the user level.

 Grey shaded fields require a selection.

 Value Dark-bordered fields require you to specify a value.

7.6.4 Load, Save

All settings to the sensor can be saved permanently in one application program, a so called setup.

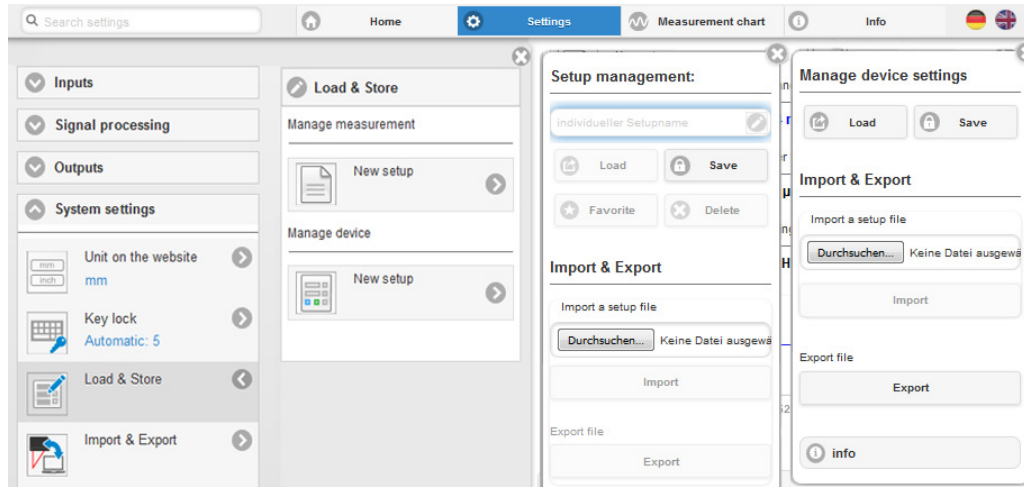
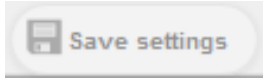

Fig. 43 Administration of application programs

Administer setups in the sensor, possibilities and procedure			
Save settings	Activate existing setup	Save changes in active setup	Define setup after booting
Menu New setup	Menu Load & Save	Menu bar	Menu Load & Save
<p>➡ Enter the name for the setup into the field <input style="width: 100px; border: 1px solid #ccc;" type="text" value="Individual setup name"/> , e.g. rubber 1.05 and click the button Save.</p>	<p>➡ Click on the setup with the left mouse button.</p> <p>The dialog Setup management opens.</p> <p>➡ Click on the button Load.</p>	<p>➡ Click on the button </p>	<p>➡ Click on the setup with the left mouse button.</p> <p>The dialog Setup management opens.</p> <p>➡ Click on the button Favorite.</p>

Exchange setup with PC/notebook, possibilities	
Save setup on PC	Load setup from PC
Menu Load & Save	Menu Load & Save
<p>➡ Click on the setup with the left mouse button, area A.</p> <p>The dialog Setup management opens.</p> <p>➡ Click on the button Export.</p>	<p>➡ Click on Create setup with the left mouse button.</p> <p>The dialog Setup management opens.</p> <p>➡ Click on the button Search.</p> <p>A Windows dialog for file selections opens.</p> <p>➡ Choose the desired file and click on the button Open.</p> <p>➡ Click the button Import in the setup management.</p>

7.6.5 Import, Export

A set of parameters covers current settings, setup(s) and the initial setup when booting the sensor. The menu `Import & Export` enables easy exchange of sets of parameters with a PC/notebook.

Exchange set of parameters with PC/notebook, possibilities	
Save set of parameters on PC	Load set of parameters from PC
Menu <code>Import & Export</code>	Menu <code>Import & Export</code>
<p>➡ Click on the button <code>New set of parameters</code> with the left mouse button.</p> <p>The dialog <code>Choose setups for export</code> opens.</p> <p>➡ You arrange a set of parameters by selecting/deselecting the check boxes.</p> <p>➡ Click on the button <code>Transmit file</code>.</p> <p>A Windows dialog for file transmission opens.</p> <p>➡ Confirm the dialog with <code>OK</code>.</p> <p>The operating system stores the set of parameters in the area <code>Download</code>.</p> <p>File name for the following example is <code><... \Downloads\ILD1320_50BASICSETTINGS_MEASSETTINGS_SCHALE_T1...SETTING_Rubber 1.05.JSON></code></p>	<p>➡ Click on the button <code>Search</code>.</p> <p>A Windows dialog for file selection opens.</p> <p>➡ Choose the desired file and click on the button <code>Open</code>.</p> <p>The dialog <code>Choose setups for export</code> opens.</p> <p>➡ You define actions to be made by selecting/deselecting the check boxes.</p> <p>➡ Click on the button <code>Transmit file</code>.</p>

Select measurement and device settings for export:

Measurement settings:

Rubber 1.05

Boot setup:

Rubber 1.05

Device settings:

Device settings

Transmit file

A security query, see adjacent figure, helps to avoid that an existing setup is inadvertently overwritten during import.

Options during import:

- Overwrite existing setups (with the same name)
- Apply settings of the imported boot setup

7.6.6 Access Authorization

The assignment of a password prevents unauthorized changing of settings on the sensor.

When delivered, the password protection is not enabled.

The sensor operates in the user level *Professional*. The password protection should be enabled after configuration of the sensor.

The default password for the expert level is 000.

i The default password or a user-defined password is not changed by a software update. The professional password is independent of the setup and is therefore not together loaded or saved with the setup.

The following functions are available for the user:

	User	Professional
Password required	no	yes
Viewing settings, signal processing, outputs, system settings	yes	yes
Changing settings, signal processing, outputs, system settings	no	yes
Changing password	no	yes
Changing between the measurement and video signal chart types	no	yes
Scaling diagrams	yes	yes
Setting factory setting	no	yes

Fig. 44 Rights in the user hierarchy

Type in the default password 000 or a user-defined password in the **Password** field and confirm with **Login**.

Change with a click on the **Logout** button in the mode user.

Fig. 45 Change in the professional user level

The user management allows you to assign a custom password in the `Professional` mode.

Password	<i>Value</i>	<i>Case-sensitive rules are observed for all passwords. Numbers are allowed. Special characters are not allowed. Maximum length is set to 31 characters.</i>
User level when restarting	<i>User / Professional</i>	<i>Specifies the user level, with which the sensor starts after the re-starting. For this purpose, MICRO-EPSILON recommends the selection <code>user</code>.</i>

After configuration of the sensor the password protection is to be activated. Please note the password for later reference.

7.6.7 Sensor Reset

Sensor reset	Sensor settings	<i>Button</i>	<i>Settings for baud rate, language, unit, keylock and echo mode are deleted and the default parameters are loaded.</i>
	Measurement settings	<i>Button</i>	<i>Settings for measuring rate, trigger, evaluation range, peak selection, error handling, averaging, zeroing/mastering, data reduction and the setups are deleted. The 1st preset will be loaded.</i>
	Reset all	<i>Button</i>	<i>When clicking this button settings for sensor, measuring preferences, access authorization, password and the setups are deleted. The 1st preset will be loaded.</i>
	Restart sensor	<i>Button</i>	<i>When clicking this button the sensor is rebooted with the settings from the setup Favorite, see Chap.7.6.4.</i>

 Grey shaded fields require a selection.

 *Value* Dark-bordered fields require you to specify a value.

8. Digital Interfaces RS422

8.1 Preliminary Remarks

The interface RS422 has a maximum baud rate of 1 MBaud. The factory-set baud rate is 921.6 kBaud. The maximum measuring rate is 4 kHz.

Data format: Measurement values in binary format, commands as an ASCII string.

Interface parameter: 8 Data bits, no parity, one stop bit (8N1).

i Disconnect or connect the D-sub connection between RS422 and USB converter when the sensor is disconnected from power supply only.

8.2 Measurement Data Format

Up to 18 bits per output value are transmitted. An output value is divided into three bytes that differ in the two most significant bits. The transmission of additional output values is optional.

Output value 1:

	Preamble		Data bits					
L-Byte	0	0	D5	D4	D3	D2	D1	D0
M-Byte	0	1	D11	D10	D9	D8	D7	D6
H-Byte	1	0	D17	D16	D15	D14	D13	D12

Output value 2 ... 32:

	Preamble		Data bits					
L-Byte	0	0	D5	D4	D3	D2	D1	D0
M-Byte	0	1	D11	D10	D9	D8	D7	D6
H-Byte	1	1	D17	D16	D15	D14	D13	D12

Depending on the measuring rate, baud rate and output data rate, all output data can be output in one block. If the output is not possible, a runtime error is issued. Data selection and output sequence is to be queried with the GETOUTINFO_RS422 command.

Output sequence: L-Byte, M-Byte, H-Byte.

The output of distance measurement value and other measurement value via RS422 requires a subsequent conversion into the corresponding unit, see [Chap.7.5.2.1](#).

8.3 Conversion of the Binary Data Format

For conversion purposes the H-Byte, M-Byte and L-Byte must be identified on the basis of the two first bits (flag bits), the flag bits deleted and the remaining bits compiled into a 16 or 18 bit data word.

Result of conversion:

D17	D16	D15	D14	D13	D12	D11	D10	D9	D8	D7	D6	D5	D4	D3	D2	D1	D0
-----	-----	-----	-----	-----	-----	-----	-----	----	----	----	----	----	----	----	----	----	----

Conversion must be done in the application program. D16 and D17 are among others used for interpretation of error codes or e.g. for the measurement counter.

•
i

The sensor continues to deliver measurement values to the RS422 output even while communicating with the sensor.

For the data transmission with a PC the MICRO-EPSILON IF2001/USB is suitable. The IF2001/USB combines the three bytes for the data word and saves them in the FIFO. The 18 bits are used for measurement values and error values. For further information, please refer to the descriptions of the IF2001/USB interface card and associated MEDAQlib driver program.

You will find the latest program routine at: www.micro-epsilon.com/link/software/medaqlib.

9. Cleaning

Cleaning of the protective screens is recommended periodically.

Avoid unnecessary laser radiation to be exposed to the human body.

➤ Switch off the sensor for cleaning and maintenance.

Dry Cleaning

Therefore an optics anti-static brush is suitable or bleeding the screen with dehumidified, clean and oil-free compressed air.

Wet Cleaning

For cleaning the protective screen use a clean, soft, lint-free cloth or lens cleaning paper with pure alcohol (isopropyl).

Never use standard glass cleaner or other cleaning agents.

10. Software Support with MEDAQLib

MEDAQLib offers you a documented driver DLL. Therewith you embed optoNCDT laser sensors, in combination with a RS422/USB converter, e. g. IF2001/USB, into an existing or a customized PC software.

MEDAQLib

- contains a DLL, which can be imported into C, C++, VB, Delphi and many additional programs,
- makes data conversion for you,
- works independent of the used interface type,
- features by identical functions for the communication (commands),
- provides a consistent transmission format for all MICRO-EPSILON sensors.

For C/C++ programmers MEDAQLib contains an additional header file and a library file. You will find the latest driver / program routine at:

www.micro-epsilon.de/download/

www.micro-epsilon.de/link/software/medaqlib/

11. Disclaimer

All components of the device have been checked and tested for functionality in the factory. However, should any defects occur despite careful quality control, these shall be reported immediately to MICRO-EPSILON or to your distributor / retailer.

MICRO-EPSILON undertakes no liability whatsoever for damage, loss or costs caused by or related in any way to the product, in particular consequential damage, e.g., due to

- non-observance of these instructions/this manual,
- improper use or improper handling (in particular due to improper installation, commissioning, operation and maintenance) of the product,
- repairs or modifications by third parties,
- the use of force or other handling by unqualified persons.

This limitation of liability also applies to defects resulting from normal wear and tear (e.g., to wearing parts) and in the event of non-compliance with the specified maintenance intervals (if applicable).

MICRO-EPSILON is exclusively responsible for repairs. It is not permitted to make unauthorized structural and / or technical modifications or alterations to the product. In the interest of further development, MICRO-EPSILON reserves the right to modify the design.

In addition, the General Terms of Business of MICRO-EPSILON shall apply, which can be accessed under Legal details | Micro-Epsilon <https://www.micro-epsilon.com/impressum/>.

12. Service, Repair

If the sensor or sensor cable is defective:

- If possible, save the current sensor settings in a parameter set, see [Chap.7.6.4](#), to reload them into the sensor after the repair.
- Please send us the effected parts for repair or exchange.

If the cause of a fault cannot be clearly identified, please send the entire measuring system to:

MICRO-EPSILON MESSTECHNIK
GmbH & Co. KG
Koenigbacher Str. 15
94496 Ortenburg / Germany

Tel. +49 (0) 8542 / 168-0
Fax +49 (0) 8542 / 168-90
info@micro-epsilon.com
www.micro-epsilon.com

13. Decommissioning, Disposal

In order to avoid the release of environmentally harmful substances and to ensure the reuse of valuable raw materials, we draw your attention to the following regulations and obligations:

- Remove all cables from the sensor and/or controller.
- Dispose of the sensor and/or the controller, its components and accessories, as well as the packaging materials in compliance with the applicable country-specific waste treatment and disposal regulations of the region of use.
- You are obliged to comply with all relevant national laws and regulations.





For Germany / the EU, the following (disposal) instructions apply in particular:

- Waste equipment marked with a crossed garbage can must not be disposed of with normal industrial waste (e.g. residual waste can or the yellow recycling bin) and must be disposed of separately. This avoids hazards to the environment due to incorrect disposal and ensures proper recycling of the old appliances.
- A list of national laws and contacts in the EU member states can be found at https://environment.ec.europa.eu/topics/waste-and-recycling/waste-electrical-and-electronic-equipment-weee_en. Here you can inform yourself about the respective national collection and return points.
- Old devices can also be returned for disposal to MICRO-EPSILON at the address given in the imprint at <https://www.micro-epsilon.com/impressum/>.
- We would like to point out that you are responsible for deleting the measurement-specific and personal data on the old devices to be disposed of.
- Under the registration number WEEE-Reg.-Nr. DE28605721, we are registered at the foundation Elektro-Altgeräte Register, Nordostpark 72, 90411 Nuremberg, as a manufacturer of electrical and/or electronic equipment.



Appendix

A 1 Optional Accessories

IF2001/USB	 <p>The image shows a white rectangular module with blue binding posts on the top and bottom. It has a green terminal block on the left side with 10 pins. The front panel features a USB Type-A port and a 6-pin female connector. Text on the module includes 'IF2001/USB Converter', 'RS422/USB', and 'Micro-Epsilon'.</p>	<p>Converter RS422 to USB, type IF2001/USB, inclusive driver, connections: 1 × female connector 10-pin (cable clamp) type Würth 691361100010, 1x female connector 6-pin (cable clamp) type Würth 691361100006</p>
IF2035-PROFINET	 <p>The image shows a white DIN rail module with a top-hat rail. It has a network port on the front panel. The front panel also features the Micro-Epsilon logo and some technical specifications.</p>	<p>Interface module for PROFINET connection of a Micro-Epsilon sensor with RS485 or RS422 interface, suitable for PCF1420-x/I or PCF1420-x/U cables, top-hat rail housing, incl. GSDML file for software integration in the PLC</p>
IF2035-EIP	 <p>The image shows a white DIN rail module with a top-hat rail. It has a network port on the front panel. The front panel also features the Micro-Epsilon logo and some technical specifications.</p>	<p>Interface module for connection of Micro-Sensors with RS422/RS485 interface to Ethernet/IP 1-channel system with DIN rail housing Software integration into the PLC with EDS file Certified according to Ethernet/IP CT16</p>
IF2035-EtherCAT	 <p>The image shows a white DIN rail module with a top-hat rail. It has a network port on the front panel. The front panel also features the Micro-Epsilon logo and some technical specifications.</p>	<p>Interface module for EtherCAT connection of a Micro-Epsilon sensor with RS485 or RS422 interface, suitable for PCF1420-x/I or PCF1420-x/U cables, top-hat rail housing, incl. ESI file for software integration in the PLC</p>
PS2020	 <p>The image shows a blue DIN rail power supply module. It has a terminal block on the top for input and output connections. The front panel features the PULS logo and some technical specifications.</p>	<p>Power supply for mounting on DIN rail, input 230 VAC, output 24 VDC/2.5 A</p>

IF2004/USB



1 channel¹ converter RS422 to USB inclusive driver,
connections: 1 × terminal block

1) One channel with ILD 1320 possible only.

A 2 Factory Settings

Password	„000“
Measuring rate	1 kHz
Measuring range	100 % FSO: I = 20 mA, digital 64887
	0 % FSO: I = 4 mA, digital 643
Peak selection	Highest peak
Error handling	Error output, no measurement

Measurement averaging	Median 9
Output	Analog current
RS422	921.6 kBaud
Trigger mode	No trigger
Language	German

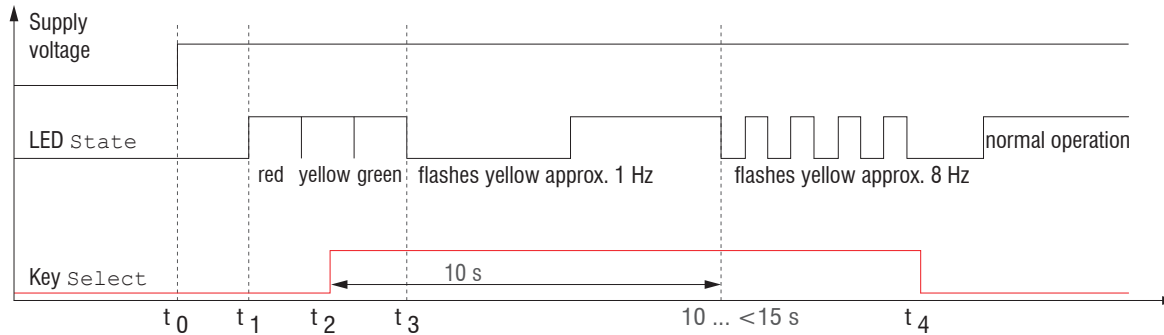

Fig. 46 Flow chart to start a sensor with factory setting

- t_0 : power supply is on
 - $t_1 \dots t_3$: both LEDs signalize the start sequence (red-yellow-green for 1 sec. each)
 - t_2 : key is pressed during start sequence ($t_1 \dots t_3$)
 - t_4 : key is released while the LED State is flashing yellow
- $\Delta t = t_4 - t_2$; Δt (key press period) must be at least 10 sec., max. 15 sec.

A 3 ASCII Communication with Sensor

A 3.1 General

The ASCII commands can be sent to the sensor via the RS422 interface. All commands, inputs and error messages are effected in English.

One command always consists of a command name and zero or several parameters, which are separated by blanks and are completed with LF. If blanks are used in parameters, the parameter must be set in quotation marks.

Example: Switch on the output via RS422

OUTPUT RS422 ←↵

Advice: ←↵ must include LF, but may also be CR LF.

Declaration: LF Line feed (line feed, hex 0A)

CR Carriage return (carriage return, hex 0D)

←↵ Enter (depending on the system System hex 0A or hex 0D0A)

The currently set parameter value is returned, if a command is activated without parameters.

The input formats are:

```
<Command name> <Parameter1> [<Parameter2> [...]]
```

```
<Command name> <Parameter1> <Parameter2> ... <Parameter...>
```

or a combination thereof.

Parameters in []-brackets are optional and require the input of the parameter standing in front. Sequent parameters without []-brackets are to input compulsory, that is, it must not be omitted a parameter.

Alternative inputs of parameter values are displayed separately by „|“, for example the values „a“, „b“ or „c“ can be set for „a|b|c“.

Parameter values in <> brackets are selectable from a value range.

Declarations on format:

„a b“	Value of the parameter can be set to the value “a” or “b”.
„ P1 P2“	It requires that both parameters “P1” and “P2” are set.
„ P1 [P2 [P3]]“	The parameters “P1”, “P2” and “P3” can be set, whereby “P2” may only be set, if “P1” is set and “P3” only if “P1” and “P2” are set.

„<a>“	The value of the parameter lies in a value range of “... to ...”, see parameter description.
-------	--

Parameter values without peak brackets can only assume discrete values, see parameter description.

Parantheses are to be understood as a grouping, that is, for a better articulation „P1 P2 | P3“ is written as „(P1 P2)|P3“.

Example without []:

„PASSWD <Old password> <New password> <New password>“

- To change the password, all three parameters are to be input.

The output format is:

<Command name> <Parameter1> [<Parameter2> [...]]

The reply can be used again as command for the parameter setting without changes. Optional parameters are only returned, if the returning is necessary. For example, the activated output values are returned by command Data selection additional values. After processing a command always a return and a prompt (“->”) is returned. In the case of an error an error message is before the prompt, that begins with „Exxx“, where xxx is a unique error number. Also warnings („Wxxx“) can be output instead of error messages.

These are analogous to the error messages. In case of warnings the command is executed.

The replies to the commands GETINFO and PRINT are useful for support requests to the sensor, because they contain sensor settings.

A 3.2 Overview Commands

Group	Chapter	Command	Short description
General			
	Chap. A 3.3.1	HELP	Help on commands
	Chap. A 3.3.2	GETINFO	Request sensor information
	Chap. A 3.3.3	LANGUAGE	Determine language of website
	Chap. A 3.3.4	RESET	Reboot sensor
	Chap. A 3.3.5	RESETCNT	Reset counter
	Chap. A 3.3.6	ECHO	Switching the command reply, ASCII interface
	Chap. A 3.3.7	PRINT	Output of all sensor settings
User level			
	Chap. A 3.3.8.1	LOGIN	Change of user level
	Chap. A 3.3.8.2	LOGOUT	Change to user in the user level
	Chap. A 3.3.8.3	GETUSERLEVEL	User level request
	Chap. A 3.3.8.4	STDUSER	Setting the standard user
	Chap. A 3.3.8.5	PASSWD	Change password
Triggering			
	Chap. A 3.3.9.1	TRIGGER	Selection of trigger mode
	Chap. A 3.3.9.2	MFILEVEL	Selection of level for multifunctional input
	Chap. A 3.3.9.3	TRIGGERCOUNT	Number of measurement values displayed
	Chap. A 3.3.9.4	TRIGGERSW	Software - trigger pulse

Interfaces			
	Chap. A 3.3.10.1	BAUDRATE	RS422 setting
	Chap. A 3.3.10.2	UNIT	Selection of measuring unit web interface
	Chap. A 3.3.10.3	MFIFUNC	Selection of function multifunctional input
	Chap. A 3.3.10.4	ERROROUT1	Activate digital output
	Chap. A 3.3.10.5	ERRORLEVELOUT1	Output level digital output
	Kap. A 3.3.10.6	ERRORLIMIT	Limit to activate digital output
	Kap. A 3.3.10.7	ERRORHYSTERESIS	Stable digital output
	Kap. A 3.3.10.8	ERROROUTHOLD	Minimum duration active digital output
Handling of setups			
	Chap. A 3.3.11.1	IMPORT	Load parameter
	Chap. A 3.3.11.2	EXPORT	Export sensor settings
	Chap. A 3.3.11.3	MEASSETTINGS	Load/save measurement settings
	Chap. A 3.3.11.4	BASICSETTINGS	Load/save device settings
	Chap. A 3.3.11.5	SETDEFAULT	Factory settings
Scaling of analog output			
	Chap. A 3.3.12	ANALOGSCALE	Scaling analog output
Key function			
	Chap. A 3.3.13.1	KEYFUNC	Selection of key function
	Chap. A 3.3.13.2	KEYLOC	Selection of keylock

Measurement			
	General		
	Chap. A 3.4.1	MEASPEAK	Choice of the peak in the video signal
	Chap. A 3.4.2	MEASRATE	Selection of measuring rate
	Chap. A 3.4.3	LASERPOW	Selection of laser power
	Measurement Value Processing		
Chap. A 3.4.4.1	MASTERMV	Mastering / Zeroing	
Data Output			
	General		
	Chap. A 3.5.1	OUTPUT	Selection measuring value output
	Chap. A 3.5.2	OUTHOLD	Setting of error processing
	Select measurement values to be output		
	Chap. A 3.5.3.1	GETOIUTINFO_RS422	Request data selection
	Chap. A 3.5.3.2	OUTADD_RS422	Selection of additional values

A 3.3 General Commands

A 3.3.1 HELP

```
HELP [<Command>]
```

Issues a help for every command. If no command is specified, a general help is output.

A 3.3.2 GETINFO, Sensor Information

```
GETINFO
```

Request of sensor information. Output see example below:

```
->GETINFO
Name:           ILD1320-10           //Model name sensor, sensor series
Serial:         15030002            //Serial number
Option:         000                 //Option number of sensor
Article:        4120209            //Article number of sensor
Cable head:     Wire
Measuring range: 10.00mm           //Measuring range of sensor
Version:        001.010            //Version of software
Hardware-rev:   00
Boot-version:   001.000
->
```

A 3.3.3 LANGUAGE, Website

```
LANGUAGE DE | EN
```

Determines the language for the web interface.

- DE: set language to German
- EN: set language to English
- CN: set language to Chinese

The chosen language setting applies to the website.

A 3.3.4 RESET, Boot Sensor

RESET

The sensor is rebooted.

A 3.3.5 RESETCNT, Reset Counter

RESETCNT [TIMESTAMP] [MEASCNT]

Sets back internal counters in the sensor.

- TIMESTAMP: sets back timestamp
- MEASCNT: sets back measurement counter

A 3.3.6 ECHO, Switching the Command Reply, ASCII Interface

ECHO ON|OFF

Setting the command reply with a ASCII command:

- ON: command reply on, for example <Kdo> ok (or notice of error)
->
- OFF: command reply off, for example ->

A 3.3.7 PRINT, Sensor Settings

PRINT

Print serves the output of all sensor settings.

Example of an answer:

```
GETUSERLEVEL PROFESSIONAL      OUTPUT ANALOG
STDUSER PROFESSIONAL          OUTADD_RS422 NONE
BAUDRATE 921600              GETOUTINFO_RS422 DIST1
UNIT MM                       OUTHOLD NONE
LANGUAGE DE                   ERROROUT1 DIST
MFIFUNC NONE                  ERRORLEVELOUT1 NPN
MFILEVEL HTL_HIGH            ANALOGSCALE STANDARD
KEYFUNC NONE
KEYLOCK AUTO 5 (IS_ACTIVE)
MEASRATE 1.000
MEASPEAK DISTA
TRIGGER NONE
TRIGGERCOUNT INFINITE
LASERPOW FULL
MASTERMV NONE
```

A 3.3.8 User Level

A 3.3.8.1 LOGIN, Change of the User Level

```
LOGIN <Password>
```

Enter the password to change user level. The following user levels are available:

- USER (standard user): “read-only” access to all elements and graphical display of output values of web surface
- PROFESSIONAL (expert): “read-only” and “write” access to all elements

A 3.3.8.2 LOGOUT, Change into User Level

```
LOGOUT
```

Set user level to USER.

A 3.3.8.3 GETUSERLEVEL, User Level Request

```
GETUSERLEVEL
```

Request current user level

A 3.3.8.4 STDUSER, Set Standard User

```
STDUSER USER|PROFESSIONAL
```

Set standard user who is automatically logged in after system start. Standard user does not change with LOGOUT which means login as standard user is done automatically after the command RESET or power supply of sensor is switched on.

A 3.3.8.5 PASSWD, Change Password

```
PASSWD <Old Password> <New password> <New password>
```

Change password for user level PROFESSIONAL.

Type in the old password followed by the new password (2x). In case the new password is not typed in correctly, an error message is will be displayed. Password may only contain letters from A to Z, no numbers 0 to 9. Watch upper and lower case lettering. The maximum length is limited to 31 characters.

A 3.3.9 Triggering

The multifunctional input also serves as trigger input for measurement output.

A 3.3.9.1 TRIGGER, Selection

```
TRIGGER NONE | EDGE | PULSE | SOFTWARE
```

- NONE: no triggering
- PULSE: level triggering
- EDGE: edge triggering
- SOFTWARE: software triggering

A 3.3.9.2 MFILELEVEL, Input Pulse Multifunctional Input

```
MFILELEVEL HTL_HIGH | HTL_LOW
```

Selection of switching or trigger level for the multifunctional input.

- HTL_HIGH: high active (edge triggering: rising edge, pulse triggering: high active)
- HTL_LOW: low active (edge triggering: falling edge, pulse triggering: low active)

A 3.3.9.3 TRIGGERCOUNT, Number of Displayed Measurement Values

```
TRIGGERCOUNT NONE | INFINITE | <n>
```

```
<1...16382>
```

Number of displayed measurement values while triggering

- NONE: stop triggering and start continuous output
- INFINITE: start continuous output after first trigger impulse
- <n>: number of displayed measurement values after each trigger impulse $n = 1 \dots 16382$

A 3.3.9.4 TRIGGERSW, Software Trigger Pulse

```
TRIGGERSW
```

Creates a trigger pulse. Error message is displayed if “SOFTWARE” is not selected in trigger selection.

A 3.3.10 Interfaces

A 3.3.10.1 BAUDRATE, RS422

```
BAUDRATE 9600|19200|56000|115200|128000|230400|256000|460800|691200|921600|  
1000000
```

Set the baud rate for the RS422 interface.

A 3.3.10.2 UNIT, Web Interface

```
UNIT MM|INCH
```

Change the measurement display on the websites. The command has no effect on the ASCII interface.

- MM representation in mm
- INCH representation in customs

A 3.3.10.3 MFIFUNC, Function Selection Multifunctional Input

```
MFIFUNC NONE | MASTER | TEACH | TRIGGER
```

Choose function of the multifunctional input.

- NONE: multifunctional input has no function
- MASTER: multifunctional input is master impulse input
- TEACH: multifunctional input is teach input for analog output
- TRIGGER: multifunctional input is trigger input

A 3.3.10.4 ERROROUT1, Activate Error Output

```
ERROROUT1 NONE|DIST|TEACH|LI1
```

Choose error signal of the digital output ERROR.

- NONE: digital ourput deactivated
- DIST: no peak found or beyond measuring range (out of range)
- TEACH: Distance is out of scaled analog range
- LI1: Distance is greater than the limit value (ERRORLIMIT)

A 3.3.10.5 ERRORLEVELOUT1, Output Level Digital Output

```
ERRORLEVELOUT1 NPN|PNP|PUSHPULL|PUSHPULLNEG
```

Choice of output level for ERROROUT1.

- NPN: digital output is active in case of an error
- PNP: digital output is active in case of an error
- PUSHPULL: digital output with high level in case of an error
- PUSHPULLNEG: digital output with low level in case of an error

Wiring of digital output ERROR1, see Chap. 5.4.8.

A 3.3.10.6 ERRORLIMIT

```
ERRORLIMIT DIST1 <upper threshold>
```

Digital output is activated, if the defined value for a measurement is exceeded.

Range: 0 ... 2 * measuring range [mm].

A 3.3.10.7 ERRORHYSTERESIS

```
ERRORHYSTERESIS <hysteresis>
```

Digital output is deactivated, if the defined value for a measurement falls below the limit value.

Range: 0 ... 2 * measuring range [mm].

A 3.3.10.8 ERROROUTHOLD

```
ERROROUTHOLD <hold period>
```

Indicates in ms how long the digital output must be active at least when the limit value is exceeded. This time period starts when the limit value is exceeded. Range: 0 ... 1000 [ms].

A 3.3.11 Handling of Setups

A 3.3.11.1 IMPORT

```
IMPORT [FORCE] [APPLY] <Data>
```

Import of data in JSON format ¹ to the sensor.

First, the import command returns a prompt (->). Afterwards, data can be sent.

After importing a prompt (->) is returned.

- FORCE: overwriting of measurement settings (= MEASSETTINGS) with the same name (otherwise an error message is returned when using the same name). When importing all measurement settings or device settings (= BASICSETTINGS) FORCE must always be stated.
- APPLY: applying the settings after importing / reading of initial settings.

1) JSON format, see https://de.wikipedia.org/wiki/JavaScript_Object_Notation

A 3.3.11.2 EXPORT

```
EXPORT ALL | MEASSETTINGS_ALL | (MEASSETTINGS <SetupName>) | BASICSETTINGS
```

Exporting sensor settings. As a response data is transmitted in JSON format. Finally a prompt occurs.

A 3.3.11.3 MEASSETTINGS, Load / Save Measurement Settings

```
MEASSETTINGS <Subcommands> [Name]
```

Settings of the measurement task.

Loads proprietary presets and one user-specific setting from the sensor or stores one user-specific setup in the sensor.

Subcommands:

- CURRENT: Output of the name of current measurement setting
- PRESETLIST: Listing of all existing presets (names): „Standard“, „Multi-Surface“, „Light Penetration“.
- LIST: Listing of all saved measurement settings (names) “Name1” “Name2” “...”.
- READ <Name>: Loads a preset or a measurement setting from the sensor.
- STORE <Name>: Saves the current measurement setting in the sensor.
- DELETE <Name>: Deletes a measurement setting
- RENAME <NameOld> <NameNew> [FORCE]: Renaming a measurement setting. An existing measurement setting can be overwritten with FORCE.
- INITIAL <name> | AUTO: Loads a named or last saved measurement setting at the start of the sensor. Presets can not be specified.

- PRESETMODE: Returns the set signal quality
- PRESETMODE <Mode>: Setting the signal quality. Setting the signal quality is possible only, if a preset was loaded.
 - <mode> = STATIC|BALANCED|DYNAMIC|NOAVERAGING|NONE

A 3.3.11.4 BASICSETTINGS, Load / Save Device Settings

```
BASICSETTINGS READ | STORE
```

- READ: Loads the stored device settings from the sensor.
- STORE: Saves the current device settings in the sensor.

A 3.3.11.5 SETDEFAULT, Default Settings

```
SETDEFAULT ALL | MEASSETTINGS | BASICSETTINGS
```

Sets sensor back to default settings.

- ALL: Measurement and device settings are being deleted. The standard preset for the measurement setting or the the default parameter for the device settings are being loaded.
- MEASSETTINGS: Measurement settings are being deleted and the standard preset is being loaded.
- BASICSETTINGS: Device settings are being deleted and the default parameters are being loaded.

A 3.3.12 ANALOGSCALE, Scaling the Analog Output

```
ANALOGSCALE STANDARD| (TWOPOINT <Minimum value> <Maximum value>)
```

Setting the two point scaling of the analog outpt.

- STANDARD: using the measuring range of the sensor
- TWOPOINT: two point scaling within the analog range (4 - 20 mA)
 - Minimum value: measurement value in mm which is matched to the lower analog value (4 mA)
 - Maximum value: measurement value in mm which is matched to the upper analog value (20 mA)

i The minimum value (in mm) can be higher than the maximum value (in mm), see Chap. 7.5.3.

A 3.3.13 Key Function

A 3.3.13.1 KEYFUNC, Choose Key Function

```
KEYFUNC NONE | MASTER | TEACH
```

Choice of key function.

- NONE: key has no function
- MASTER: key is used for mastering
- TEACH: key is used for teaching

A 3.3.13.2 KEYLOCK, Set Keylock

```
KEYLOCK NONE|ACTIVE|AUTO <time>
```

Choice of keylock.

- NONE: key works permanently, no keylock
- ACTIVE: keylock is activated right after reboot
- AUTO: keylock is only activated <time> minutes after reboot

A 3.4 Measurement

A 3.4.1 MEASPEAK, Choice of the Peak in the Video Signal

```
MEASPEAK DISTA|DIST1|DISTL
```

- DISTA: output of peak with highest amplitude (standard)
- DIST1: output of first peak
- DISTL: output of last peak

A 3.4.2 MEASRATE, Measuring Rate

```
MEASRATE 0.25|0.5|1|2|4
```

Choice of measuring rate in kHz.

A 3.4.3 LASERPOW, Laser Power

```
LASERPOW FULL|OFF
```

- FULL: laser power is set to 100 %
- OFF: laser is switched off

A 3.4.4 Measurement Value Processing

A 3.4.4.1 MASTERMV, Mastering / Zeroing

```
MASTERMV NONE | MASTER <MV>
```

- NONE: completes mastering
- MASTER: sets the current measurement value as a master value
- MV: master value in millimeters; $MV = (0 \dots 2) * \text{measuring range}$, i.e. master value must be within measuring range

In case of master value is 0, the mastering has the same functionality as the zeroing. The parameter MV always operates independently from an input as zeroing during mastering the analog output.

The master command awaits the next measurement value, a maximum of 2 seconds, and masters it. If no measurement value is received within this time, for example, by external triggering, the command returns with the error "E220 Timeout".

The master value is processed with six decimal places.

Note that the output value is limited to 18 bits.

A 3.5 Data Output

A 3.5.1 OUTPUT, Selection of Measurement Value Output

```
OUTPUT NONE | RS422 | ANALOG
```

- NONE: no measurement value
- RS422: output of measurement value via RS422
- ANALOG: analog output of measurement values

A 3.5.2 OUTHOLD, Error Processing

```
OUTHOLD NONE | INFINITE | <n>
```

Setting the behavior of the measurement value output in case of error.

- NONE: no holding of the last measurement value, output of error value
- INFINITE: infinite holding of the last measurement value
- <n>: holding of the last measurement value on the number of measurement cycles; then an error value is output, $n = (1 \dots 1024)$

A 3.5.3 Selection of Measurement Values to be Output

A 3.5.3.1 GETOUTINFO_RS422, Request Data Selection

```
GETOUTINFO_RS422
```

The command lists all selected output data for the RS422 interface. The sequence shown corresponds to the output sequence.

A 3.5.3.2 OUTADD_RS422, Selection of Data Additional Values

```
OUTADD_RS422 NONE| ([SHUTTER] [COUNTER] [TIMESTAMP] [INTENSITY] [STATE]
[DIST_RAW])
```

Selection of additional values to be transmitted.

- NONE: no output of additional values
- SHUTTER: output of exposure time
- COUNTER: output of measurement value counter
- TIMESTAMP: output of timestamp
- INTENSITY: output of intensity parallel to each distance value
- STATE: output of status word
- DIST_RAW: output of uncalibrated distance value (raw value)

A 3.6 Example Command Sequence During Selection of Measurement Value

Command	Content
MEASPEAK	Peak selection for displacement measurement
MEASRATE	Measuring rate (under consideration of reflectivity and movement of the target)
OUTPUT	Selection of the output channel
OUTHOLD	Output characteristic during measurement errors
OUTADD_RS422	Selection of the additional values to be output for RS422 interface
BAUDRATE	Baud rate settings RS422 interface

A 3.7 Error Messages

If an error occurs with a command, the error message is listed.

Error message	Description
E100 Internal error	Internal error code
E104 Timeout	Timeout while mastering.
E200 I/O operation failed	Cannot write data to the output channel.
E202 Access denied	Access denied: Login as expert is necessary.
E204 Received unsupported character	An unsupported character was received
E210 Unknown command	Unknown command rights to small to read).
E214 Entered command is too long to be processed	The entered command with the parameters is too long (greater than 255 bytes).
E220 Timeout, command aborted	Timeout during mastering.
E232 Wrong parameter count	Too high or too small number of parameters.
E234 Wrong or unknown parameter type	A transmitted parameter has a wrong type or a wrong number of parameters were transmitted.
E236 Value is out of range or the format is invalid	The parameter value is out of range of the value range.
E262 Active signal transmission, please stop before	A measurement value transmission is active. Stop the data transmission in order to execute the command.
E320 Wrong info-data of the update	For update only: the header of update data contains an error.
E321 Update file is too large	For update only: update data is too large.
E322 Error during data transmission of the update	For update only: error during update data transmission.
E323 Timeout during the update	For update only: Timeout during the transmission of update data.
E331 Validation of import file failed	The import file is not valid.
E332 Error during import	Error during processing the import data
E333 No overwrite during import allowed	No overwrite of measurement and device settings allowed through import, set the checkbox.
E350 The new passwords are not identical	Password and verification password do not match.

E360 Name already exists or not allowed	The measurement setting name already exists or is not allowed.
E361 Name begins or ends with spaces or is empty	Name for the measurement setting begins or ends with spaces or is empty.
E362 Storage region is full	Number of storable measurement settings is reached.
E363 Setting name not found	Name of the measurement setting to be loaded not found
E364 Setting is invalid	Measurement or device setting is invalid
E602 Master value is out of range	Master value is out of valid range
E616 Software triggering is not active	Software triggering is not active.

Warning	Description
W320 The measuring output has been adapted automatically.	The measuring output has been adapted automatically.

A 4 Control Menu

A 4.1 Tab Home

Measurement task	Presets	Standard	Suitable for materials made of ceramics, metal or filled plastics
		Multi surface ¹	Suitable for e.g. PCB or hybrid materials
		Light penetration ¹	Suitable for plastics (POM, Teflon), materials with strong penetration of the laser
	Setup	Setup 1	A setup contains user-specific measurement settings. Unlike the presets it can be changed anytime.
Signal quality		Static / balanced / dynamic / off	The signal quality affects averaging of measurement values.

A 4.2 Tab Settings

A 4.2.1 Inputs

Laser on/off	On / Off		Laser on/off is only effective when pin 8 is connected to GND.
Multifunctional input	Zeroing (Mastering)	High / Low	Sets the function of the switching input. The trigger affects recording and output of a measurement value. Zeroing/Mastering sets the current measurement value to the entered master value. Teaching scales the analog output. HTL is defined as active input level.
	Trigger In	High / Low	
	Teaching		
	Inactive		
Key function	Zeroing (Mastering)		Sets the function of the sensor key. Inactive means keylock.
	Teaching		
	Inactive		

1) Available for the sensor models ILD1320-10/25/50.

A 4.2.2 Signal Processing

Measurement task	Standard			Suitable for materials made of ceramics, metal or filled plastics	
	Changing surface ¹			Suitable for e.g. Printed circuit boards (PCB) or hybrid materials	
	Material with penetration ¹			Suitable for plastics (POM, Teflon), materials with strong penetration of the laser	
Measuring rates	250 Hz / 500 Hz / 1 kHz / 2 kHz / 4 kHz			For light and matt measuring objects a high measuring rate may be required. For dark or bright measuring objects a slower measuring rate may be required (e.g. black lacquered surface) to improve the measuring result.	
Output trigger	Level			Continuous measurement output takes place as long as the selected level is applied. Level selection, see Chap.7.3 . Pulse duration must at least be one cycle time. The subsequent break must also be at least one cycle time.	
	Edge	infinite			Edge selection. „0“ end trigger, „1 ... 16382“ values per trigger, „16383“ infinite trigger
		manual	Number	Value	
	Software	infinite			Software triggering is started by clicking the button <i>Release trigger</i> . „0“ end trigger, „1 ... 16382“ values per trigger, „16383“ infinite trigger
		manual	Number	Value	
Inactive				No triggering	

1) Available for the sensor models ILD1320-10/25/50.

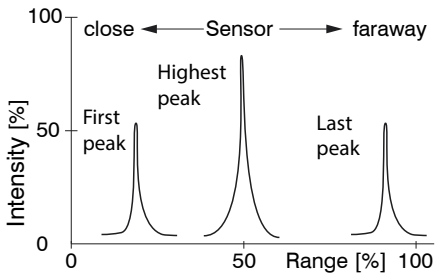
Selection of peak	<i>First peak / Highest peak / Last peak</i>	<p><i>Defines which signal is used for the evaluation in the line signal.</i></p> <p><i>First peak: Nearest peak to sensor.</i></p> <p><i>Highest peak: standard, peak with the highest intensity.</i></p> <p><i>Last peak: widest peak to sensor.</i></p>	
Error handling	<i>Error output, no measurement value</i>	<p><i>The analog output supplies 3 mA instead of measurement value.</i></p> <p><i>The RS422 interface outputs an error value.</i></p>	
	<i>Hold last value infinite</i>	<p><i>Analog output and RS422 interface stop at the last valid value.</i></p>	
	<i>Hold last value</i>	<p>1 ... 1024</p>	<p>Value</p>
Zeroing/ Mastering	<p><i>Inactive</i></p>		<p><i>Normal measurement value or Zeroing/Mastering is undone.</i></p>
	<p><i>Active</i></p>	<p>Value</p>	<p><i>Indication e.g. of thickness of a master part.</i></p> <p><i>Value range 0 up to max. + 2 x measuring range</i></p>

A 4.2.3 Outputs

RS422	Baud rate	9.6 / 19.2 / 56.0 / 115.2 / 230.4 ... / 1000 kBps		Transmission speed, binary data format
	Output data	Distance / Exposure time / Intensity / Sensor status / Measurement value counter / non-linearized center of gravity / Timestamp		Date to be transmitted are to be activated via the checkbox.
Analog output	Standard scaling			Start of measuring range 4 mA, at end of measuring range 20 mA
	Two point scaling	Start of range	Value	Always 2 points are taught which mark start and end of new measuring range. With two point scaling reversal of the output signal is possible.
		End of range	Value	
Digital output	Inactive			Regulates the switching performance of the digital output (Error), see Chap.5.4.8 . Analog range: digital output switches when the scaled analog range is exceeded.
	Analog range / Measuring range	NPN / PNP / PushPull / PushPullNeg		
	Limit monitoring	NPN / PNP / PushPull / PushPullNeg		Measuring range: The digital output is switched when the peak is not (entirely) in evaluation range (ROI).
		Limit	Value	
		Hysteresis	Value	Limit monitoring: digital output switches when the limit is exceeded.
Minimum holding period	Value			
Output interface	Web interface / Analog / RS422			Decides on the used interface for measurement value output. A parallel physical measurement value output via RS422 and analog is not possible. If web interface was selected, no measurement values are output via RS422 or current output.

		LED Output	Web interface		RS422	Current output
			Parametrization	Measurement chart		
Selected output interface	Web interface	yellow	•	•		
	RS422	green	•		•	
	Analog	red	•	•		•

A 4.2.4 System Settings

Unit on website	<i>mm / inch</i>		<i>Unit in measurement value display</i>	
Keylock	<i>Automatically</i>	<i>Range 1 ... 60 [min]</i>	<i>Value</i>	<i>The keylock starts after expiry of the defined time. Clicking the button <i>Refresh</i> extends the interval until keylock starts.</i>
		<i>Refresh</i>		
	<i>Active</i>			<i>The key <i>Select</i> does not respond to entries, independent of user level.</i>
	<i>Inactive</i>			<i>The key <i>Select</i> is active, independent of user level.</i>
Load & Save	Measurement settings	<i>Create setup / Setup</i>	<i>Load</i>	<i>Activates a saved measurement setting setup.</i>
			<i>Save</i>	<i>Saves changed measurement settings to an existing setup.</i>
			<i>Favorite</i>	<i>Selects a setup which is used after reboot of the sensor.</i>
			<i>Delete</i>	<i>Deletes a setup.</i>
			<i>Search</i>	<i>You load an existing setup from a PC or the like to the ILD 1320 with both buttons.</i>
			<i>Import</i>	
		<i>Export</i>	<i>Saves the setup on a connected PC or the like.</i>	
	Device settings	<i>Create setup</i>	<i>Load</i>	<i>Activates the saved device settings.</i>
			<i>Save</i>	<i>Saves changed device settings.</i>
			<i>Search</i>	<i>You load the device settings from a PC or the like to the ILD 1320 with both buttons.</i>
<i>Import</i>				
<i>Export</i>			<i>Saves the device settings on a connected PC or the like.</i>	

Import & Export	Create file	<i>Measurement settings</i>		<i>The measurement setting setups, the file with device settings and the boot file can be combined in one parameter set and exchanged with a PC or the like.</i>
		<i>Boot setup</i>		
		<i>Device settings</i>		
	Search		<i>Button starts file manager to select a parameter set.</i>	
Check file	<i>Overwrite existing setups (with the same name)</i>		<i>Dialog prevents inadvertent overwriting of existing settings.</i>	
	<i>Apply settings of the imported boot setup</i>			
	<i>Transmit data</i>			
Access permission	Current access permission	<i>Value</i>		<i>Read only</i>
	<i>Logout / Login</i>			<i>Button starts change of access permission.</i>
	User level reboot	<i>Professional / User</i>		<i>Sets the user level the sensor starts with after reboot. In this case MICRO-EPSILON recommends the selection user.</i>
	Change password	Old password	<i>Value</i>	<i>Case-sensitive rules are observed for all passwords. Numbers are allowed. Special characters are not allowed. Maximum length is limited to 31 characters.</i>
		New password	<i>Value</i>	
		Repeat new password	<i>Value</i>	
	<i>Change password</i>			<i>Button causes change of password.</i>

Reset sensor	<i>Measurement settings</i>	<i>The settings for measuring rate, trigger, evaluation range, selection of peak, error handling, averaging, Zeroing/Mastering, reduction of data and setups are deleted. The 1st preset is loaded.</i>
	<i>Device settings</i>	<i>The settings baud rate, language, unit, keylock and echo mode are deleted and the default parameters are loaded.</i>
	<i>Reset all</i>	<i>By clicking the button the settings for the sensor, measurement settings, access permission, password and setups are deleted. The 1st preset is loaded.</i>
	<i>Restart sensor</i>	<i>By clicking the button the sensor is rebooted with the settings made in the favorite setup, see Chap.7.6.4.</i>

 Selection required or checkbox

 *Value* Specification of a value required

i The settings will be effective, if you click on the button `Apply`. After the programming all settings must be permanently stored under a parameter set so that they are available again when the sensor is switched on the next time.



MICRO-EPSILON MESSTECHNIK GmbH & Co. KG
Koenigbacher Str. 15 · 94496 Ortenburg / Germany
Tel. +49 (0) 8542 / 168-0 · Fax +49 (0) 8542 / 168-90
info@micro-epsilon.com · www.micro-epsilon.com

Your local contact: www.micro-epsilon.com/contact/worldwide/

X9751350-A112094TSw
© MICRO-EPSILON MESSTECHNIK