

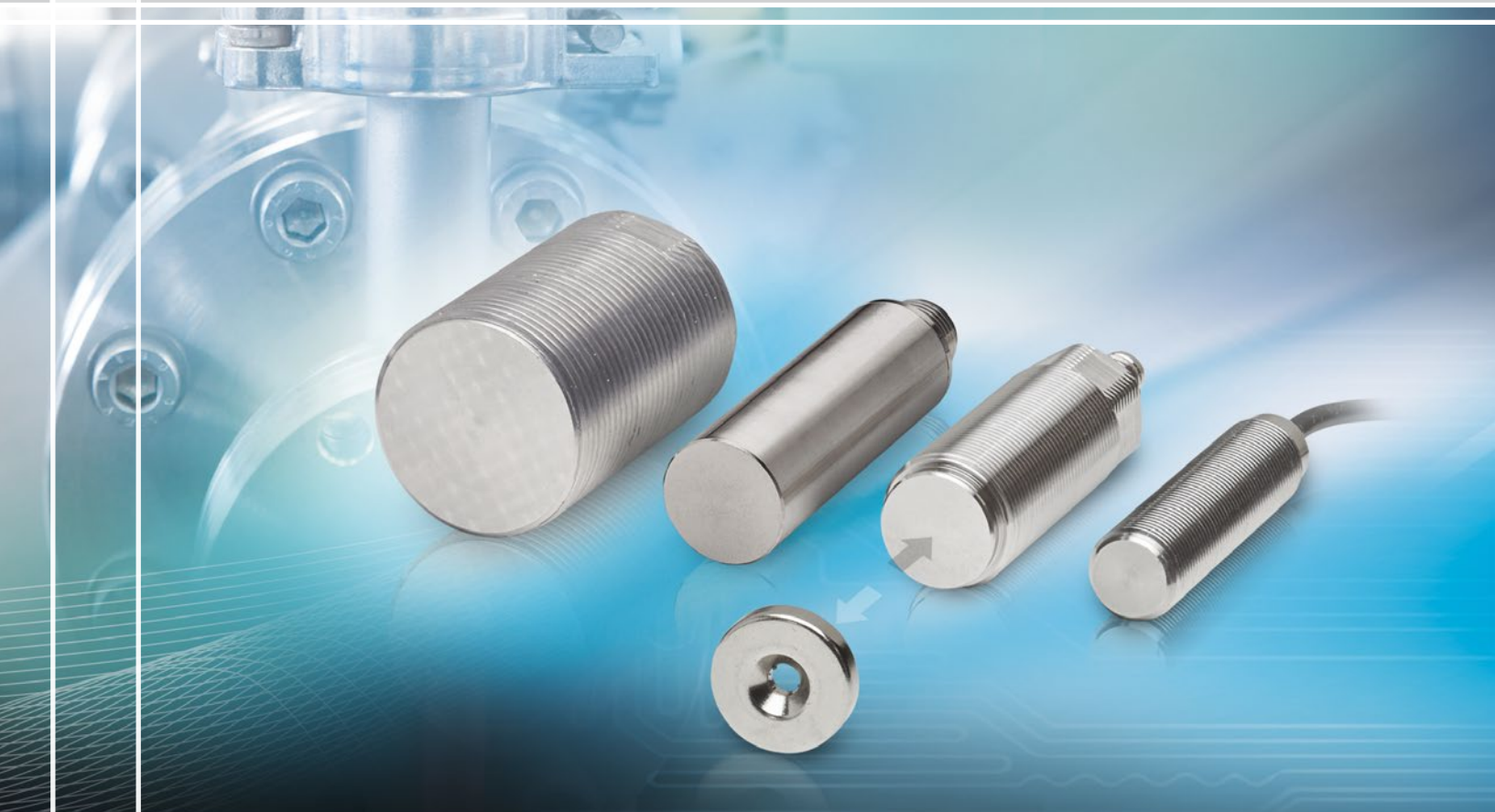

# More Precision

**mainSENSOR** // Magneto-inductive displacement sensors





- *Selectable measuring ranges up to 55 mm*
- *Linear output signal*
- *High basic sensitivity and temperature stability*
- *Non-contact and wear-free operation*
- *High dynamics*
- *Available in any quantity*

#### Measuring principle

mainSENSOR is based on an innovative measuring principle, which has been developed by Micro-Epsilon in order to combine the advantages of both inductive and magnetic sensors.

A magnet is fixed to the measurement object. The movement of the magnet induces a change in the magnetic flow in the sensor element, which is detected by the sensor coil. A linear relationship between output signal and magnet distance (self-linearization technology) is produced due to counteracting physical effects. As different strength magnets are applied, measuring ranges of up to 55 mm can be achieved. However, for changing the measuring range, it is only necessary to change the magnet. As well as for displacement and distance measurements, these sensors are also used in special applications such as rotational speed measurement of e.g. shafts and gear wheels.

#### Flexibility

The flexible concept makes the sensors suitable for the application in different fields of application especially in case of high quantities. The standard sensors are designed with an industrial-grade M12, M18 or M30 stainless steel housing or with a flat plastic housing. The integrated evaluation electronics is situated on a compact PCB. In high volume production, customer-specific modifications to the PCB and sensor housing can be implemented at low cost.

#### No calibration required

The automatic sensor linearization ensures a linear sensor signal. Therefore, no calibration is required which makes the installation of multiple sensors incredibly simple. Before starting the operation, only the zero point has to be set by positioning the sensor and the magnet. Consequently, the sensors are ready for use within a short time.

#### Robustness

- Stainless steel housing (insensitive to dirt, oil, etc.)
- Protection classes up to IP67 and IP69K
- Pressure resistance
- Food grade



### Automation, machine building and OEM applications

Magneto-inductive sensors from Micro-Epsilon have many potential areas of use, including individual applications in conventional machine building to measurements in automated processes and cost-sensitive high volume production.



Picture: Uhlmann Pac-Systeme GmbH & Co. KG

#### Foreign body detection in medical technology

In this application, the MDS sensor recognizes foreign bodies in blister machines during the tablet packaging process. Via the movement of overhead touching rollers, foreign bodies between the blister packaging and covering material can be detected. Exceeding a pre-defined point triggers an alarm.



Picture: SIG Combibloc Group AG

#### Valve lift measurement in the food industry

During the filling of drinks cartons, the exact dosage is a critical factor. The sensor measures the valve lift of the filling line and requests several switching points in a measuring range of 35mm. The sealed stainless steel housings of the MDS-45-Mxx series are ideal for the food industry.



#### Rotational speed measurement in marine diesel

Integrating the magnet into the sensor housing (magnetic bias) enables the detection of large ferromagnetic particles. This effect is useful for measuring the rotational speed of gear wheels in marine diesel engines. This special arrangement can be found in one of the customer-specific sensors.



#### Imbalance and load detection in washing machines

Integrating displacement measurement into the washing machine damper helps to detect the imbalance and the loading of the drum. This measurement is performed using the cost-effective MDS-40-LP series sensor. A conventional hard ferrite magnet is integrated into the damper while the sensor board can later be clipped on from the outside.

### Installation

Unlike inductive sensors, Micro-Epsilon's magneto-inductive sensors offer versatile installation possibilities. The sensor can be immersed in non-ferromagnetic objects, flush mounted or protruding without influencing the measurement accuracy. The magnet is mounted to the measurement object using a stainless steel screw, which is supplied with the sensor.



### Measuring through non-ferromagnetic materials

Unlike conventional measuring procedures, the magneto-inductive sensor also measures through non-ferromagnetic materials such as aluminum and steel. A clear benefit is provided here as the sensor and the magnet can be installed separately in applications with closed systems or housings. It is therefore possible to mount the magnet safely in harsh environments and the sensor in protected areas.

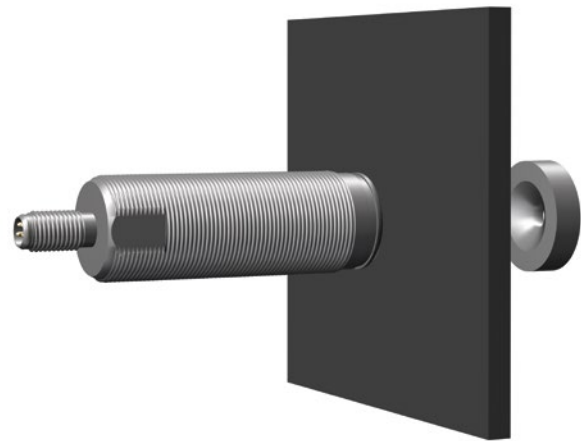

### Axial and side-shifted distance and displacement measurements

mainSENSOR detects the position of a magnet, which is fixed to the measurement object. The magnet can be applied to the sensor either axially or side on. Due to the flat design of the sensor element, a magnet

offset of a few millimeters do not influence the characteristic curve. Larger offsets influence the signal (linearity and gradient). Especially in the case of restricted installation spaces, side shifted measurement offers a space saving alternative.

Axial measurement direction

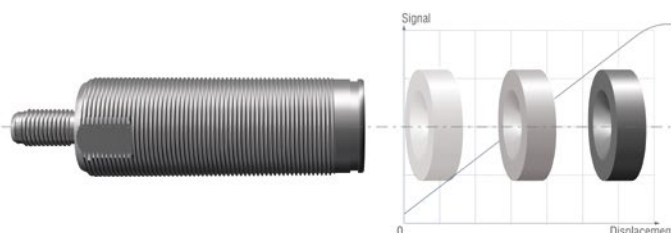

Side shifted measurement direction

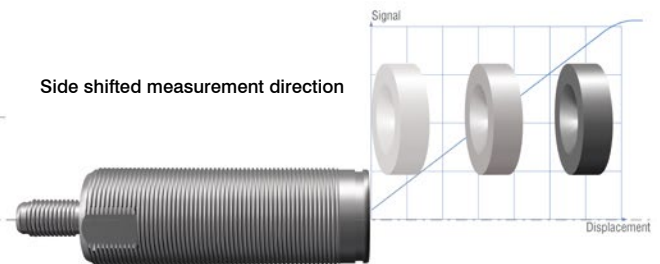

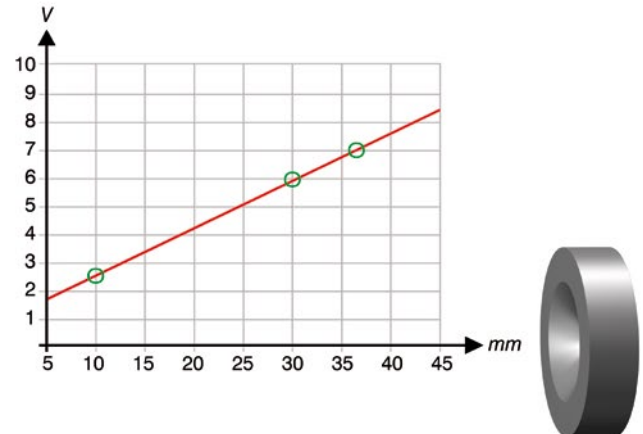

#### Advantages over inductive sensors

- Constantly high sensitivity, even at the end of measuring range
- High protection class (solid metal housing)
- Compact design with large measuring range (e.g. M12 at 55 mm measuring range)
- Flush installation in non-magnetic materials
- Measurements on electrically conductive and non-magnetic materials (stainless steel, aluminum...)
- Excellent linearity

#### Ideal alternative to switches and proximity sensors

Magneto-inductive sensors are the preferred alternative to switching elements. The user can generate as many switching points as desired from the continuous analog signal.

- No complex, mechanical adjustments are required for setting the switching point
- Definition of almost any number of switching points
- One sensor model suitable for many different distances

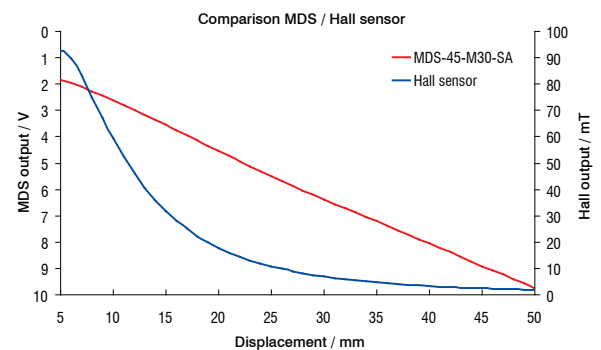
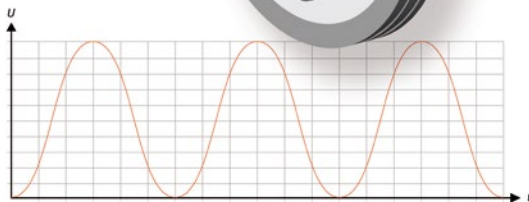

#### Rotational speed measurement

In addition to displacement and distance measurements, mainSENSOR can also be used to measure rotational speed. In order to do this, one or two magnets are mounted on the rotating measurement object. Regardless of the direction of rotation, the sensor measures the speed of the target object. In addition, customer-specific models are able to recognize the direction of rotation. Therefore, two sensor components that detect and evaluate the direction of the signal increase are installed.

#### Advantages over magnetic sensors based on Hall Effect components

- Significantly extended measuring range
- Continuous output signal is linear to the distance
- Significant price advantages with large measuring ranges
- Signal stability when magnet is not centered



MDS-45 is the industry-standard version of the magneto-inductive sensor. These stand out due to the common characteristics of this product series and also because of their very robust standard housing.

They are available in M18 and M30 stainless steel housings. The stainless steel housing is ideally suited to demanding environments (dirt, oil, chemicals) and the food industry.

**MDS-45-M18-SA / MDS-45-M18-HP-SA**

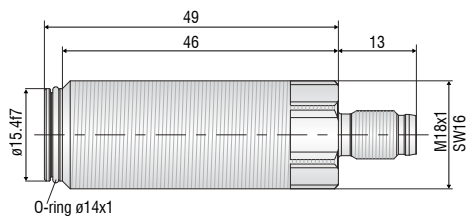

**MDS-45-M30-SA**

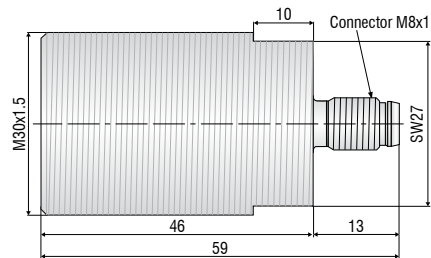

**MDS-45-M18-SA (01)**

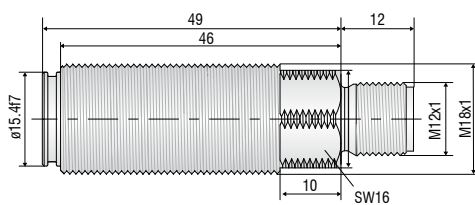

Model	MDS-45-M18-SA	MDS-45-M18-SA(01)	MDS-45-M18-HP-SA	MDS-45-M30-SA
Measuring range <sup>1)</sup>	45 mm (for other measuring ranges see page 18)			
Magnet included in delivery	MB45	-	MB45	MB45
Start of measuring range <sup>1)</sup>	2.25 mm			4 mm
Resolution <sup>3)</sup>	Voltage	0.05 % FSO		0.05 % FSO
	Current	-		0.2 % FSO
Linearity <sup>1)2)</sup>	≤ ±3 % FSO			
Repeatability	≤ ±0.05 % FSO			
Frequency response (-3dB)	3000 Hz			1000 Hz
Temperature stability	≤ 250 ppm FSO/K			
Supply voltage	11.5 ... 30 VDC			
Max. current consumption	20 mA (with voltage output); 40 mA (with current output)			
Analog output	Voltage	2 ±0.3 ... 9.6 ±0.4 V		2 ±0.2 ... 9.6 ±0.4 V
	Current	-		4 ±0.4 mA ... 19.2 ±0.8 mA
Connection	Supply/signal: screw/plug connection 4-pin M8; axial output <sup>5)</sup>	Supply/signal: screw/plug connection 4-pin M12; axial output <sup>5)</sup>	Supply/signal: screw/plug connection 4-pin M8; axial output <sup>5)</sup>	
Mounting	Thread M18x1			Thread M30x1.5
Temperature range	Storage	-20 ... +80 °C		
	Operation	-20 ... +80 °C		
Pressure resistance	100 bar (front)	400 bar (front)	40 bar (front)	
Shock (DIN EN 60068-2-27)	40 g / 6 ms, 1000 shocks; 100 g / 6 ms, 3 shocks			
Vibration (DIN EN 60068-2-6)	10 ... 58 Hz ±1.5 mm / 58 ... 500 Hz ±20 g per axis, 10 cycles			
Protection class (DIN EN 60529)	IP67 <sup>4)</sup> ; higher protection class available on request			
Material	Stainless steel			
Weight	approx. 40 g			approx. 110 g
Features	-	-	Seawater resistant	-

FSO = Full Scale Output

<sup>1)</sup> Measuring range changes by using other magnets (see catalog p.18); external magnetic fields and/or ferromagnetic material in the measuring range of the sensor system affect the sensor characteristic line and the technical data.

<sup>2)</sup> Deviation to the regression curve according to the method of least squares

<sup>3)</sup> Peak-Peak; external first-order low pass; frequency response 5 kHz

<sup>4)</sup> For plug versions only in plugged and screwed condition

<sup>5)</sup> Connection cable see accessories

## Sensor signal

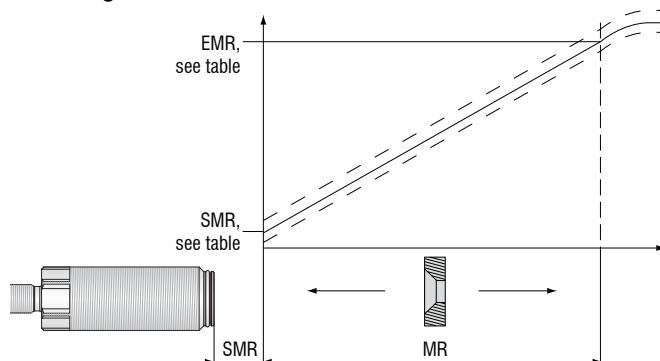

MDS-45	SMR		EMR
-M18-SA	2V ±0.3V	2.25 mm	9.6 V ±0.4 V
-M18-SA(01)	2V ±0.3V	2.25 mm	9.6 V ±0.4 V
-M18-HP-SA	2V ±0.3V	2.25 mm	9.6 V ±0.4 V
-M30-SA	4 mA ±0.4 mA 2V ±0.2V	4 mm	19.2 mA ±0.8 mA 9.6 V ±0.4 V

MR = Measuring range, SMR = Start of measuring range, EMR = End of measuring range



Magneto-inductive M12 sensors are industrial-grade models for restricted installation spaces. Designed for use in harsh environments and high temperatures up to 120 °C, these sensors are available either with connector or integrated cable. MDS-M12 sensors are ideally suitable for applications in demanding, industrial environments.

MDS-45-M12-CA

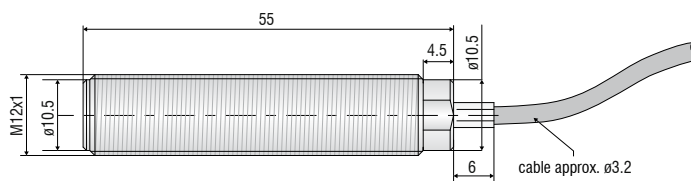

MDS-45-M12-SA

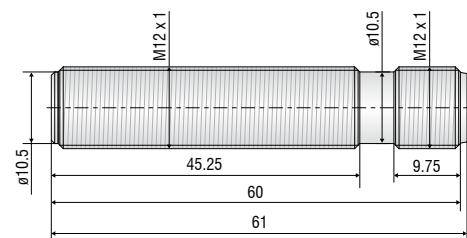

MDS-35-M12-CA-HT

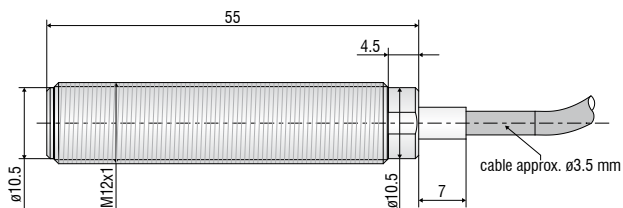

MDS-35-M12-SA-HT

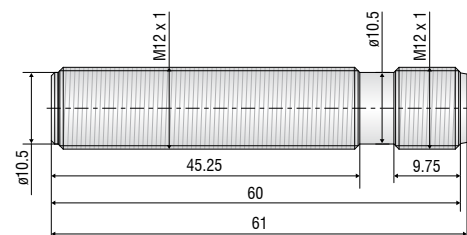

(Dimensions in mm, not to scale)



Model	MDS-45-M12-CA	MDS-45-M12-SA	MDS-35-M12-CA-HT	MDS-35-M12-SA-HT
Measuring range <sup>1)</sup>	45 mm (for other measuring ranges see page 18)		35 mm (for other measuring ranges see page 18)	
Magnet included in delivery	MB45		MB35HT	
Start of measuring range <sup>1)</sup>	5 mm		1 mm	
Resolution <sup>3)</sup>	0.05 % FSO			
Linearity <sup>1)2)</sup>	≤ ±3 % FSO		≤ ±5 % FSO	
Repeatability	≤ ±0.05 % FSO			
Frequency response (-3dB)	3000 Hz		5000 Hz	
Temperature stability	≤ 250 ppm FSO/K		≤ 500 ppm FSO/K	
Supply voltage	11.5 ... 30 VDC			
Max. current consumption	20 mA		15 mA	
Analog output	2 ±0.3 ... 9.6 ±0.4 V		2 ±0.4 ... 9.6 ±0.4 V	
Connection	Supply/signal: integrated cable 4-pin, length 3 m; open ends	Supply/signal: M12 screw/plug connection 4-pin; axial output <sup>5)</sup>	Supply/signal: integrated cable 4-pin, length 3 m; open ends	Supply/signal: M12 screw/plug connection 4-pin; axial output <sup>5)</sup>
Mounting	Thread M12x1			
Temperature range	Storage	-20 ... +80 °C		-20 ... +120 °C
	Operation	-20 ... +80 °C		-20 ... +120 °C
Pressure resistance	100 bar (front)		5 bar (front & rear)	5 bar (front)
Shock (DIN EN 60068-2-27)	40 g / 6 ms, 1000 shocks; 100 g / 6 ms, 3 shocks			
Vibration (DIN EN 60068-2-6)	10 ... 58 Hz ±1.5 mm / 58 ... 500 Hz ±20 g per axis, 10 cycles			
Protection class (DIN EN 60529)	IP67 <sup>4)</sup> ; higher protection class available on request		IP68 permanent	IP65 <sup>4)</sup>
Material	Stainless steel			
Weight	approx. 60 g	approx. 20 g	approx. 25 g	approx. 20 g
Features	-	-	-	-

FSO = Full Scale Output

<sup>1)</sup> Measuring range changes by using other magnets (see catalog p.18); external magnetic fields and/or ferromagnetic material in the measuring range of the sensor system affect the sensor characteristic line and the technical data.

<sup>2)</sup> Deviation to the regression curve according to the method of least squares

<sup>3)</sup> Peak-Peak; external first-order low pass; frequency response 5 kHz

<sup>4)</sup> For plug versions only in plugged and screwed condition

<sup>5)</sup> Connection cable see accessories

## Sensor signal

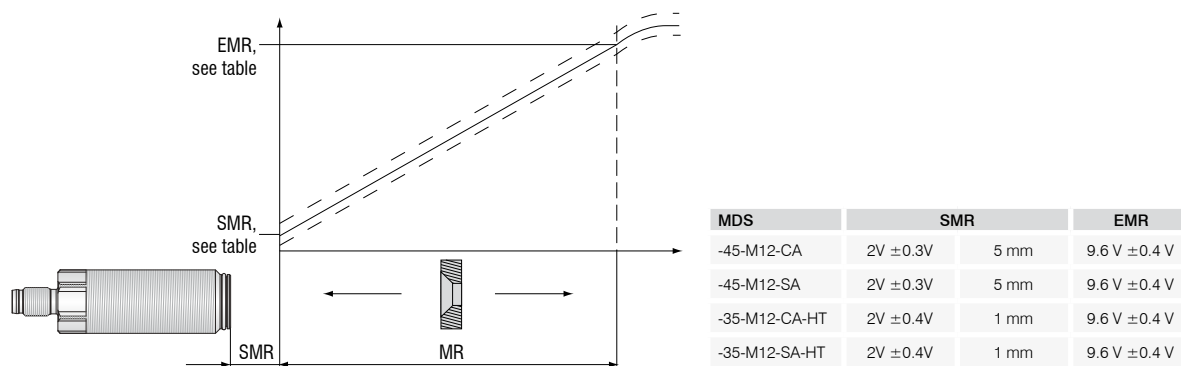

MR = Measuring range, SMR = Start of measuring range, EMR = End of measuring range



The sensors of the MDS-40-MK series are the new generation of cost-effective and flexible magneto-inductive sensors. In addition to the pre-configured preferred types, a combination of further options (power supply, output, plug,...) for serial or industrial applications is possible.

#### Possible combinations

The following combinations are possible from a quantity of 200 pieces.

#### Options

MDS - 40 - MK - SA8 - I - 1130 - IP20 - FIX

**FIX:** Optimal retaining plate for curved surfaces

**Protection class:** IP67 (casting)  
IP20V (IP20 with partial casting)  
IP20 (not molded)

**Supply voltage:** 1130 (11...30 V)  
5 (5 V)  
33 (3.3 V)

**Output:** I (4...20 mA)  
U10 (2...10 V)  
U45 (0.5...4.5 V)  
U45R (0.5...4.5 V, ratiometric)  
F (frequency: time measurement)

**Connection:** SA8 (M8x1, axial)  
SR7 (JST JWPF, radial)  
SR0 (JST PA, radial)

		Power supply		
		1130	5	33
Output	I	•	-	-
	U10	•	-	-
	U45	•	•	-
	U45R	-	•	•
	F	•	•	•
		Connector / cable		
		SA8	SR7	SR0
Protection class	IP20	•	•	•
	IP67	•	•	-

• Combination possible  
- Combination not possible

#### Main measurement direction

The above-mentioned data refer to the main measurement direction; however, other magnet arrangements and directions of movement are possible and can result in a change of the characteristic line. The magnets can be positioned either to the left or to the right of the sensor regardless of whether the north or the south pole is turned towards the sensor.

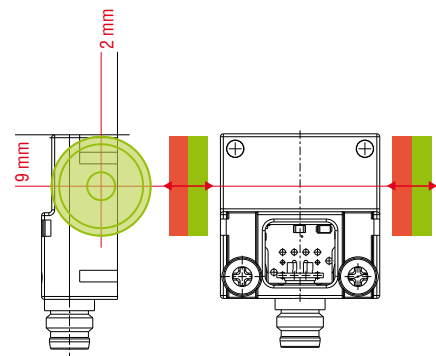

Preferred types					
Model	MDS-40-MK-SA8-I	MDS-40-MK-SR7-U10	MDS-40-MK-SR7-U45R	MDS-40-MK-SR0-F	MDS-40-MK-XXX
Measuring range <sup>1)</sup>	RL21 magnet: 30 mm (for other measuring ranges see page 18)				
Magnet included in delivery	-				
Start of measuring range <sup>1)</sup>	Magnet RL21: 1.5 mm				
Resolution <sup>3)</sup>	0.05 % FSO				
Linearity <sup>1) 2)</sup>	≤ ±3 % ... ≤ ±5 % FSO				
Repeatability	≤ 0.05 % FSO				
Frequency response (-3dB)	1000 Hz				
Temperature stability	≤ 500 ppm FSO/K				
Supply voltage	11.5 ... 30 VDC			5 VDC	selectable
Max. current consumption	35 mA	13 mA	16 mA with Ub=5 VDC	8.5 mA with Ub=5 VDC	-
Analog output	4 ... 20 mA	2 ... 10 V	0.5 ... 4.5 V	typ. 402 ... 274 Hz (rectangle) (time measurement, p.19)	selectable
Connection	Supply/signal: M8 screw/plug connection 4-pin; axial output <sup>5)</sup>	Supply/signal: JST JWPF plug-in connection 4-pin; radial output <sup>5)</sup>		Supply/signal: JST PA- plug-in connection 4-pin; radial output <sup>5)</sup>	selectable
Mounting	Through bores				
Temperature range	Storage			-20 ... +80 °C	
	Operation			-20 ... +80 °C	
Shock (DIN EN 60068-2-27)	40 g, 6 ms, 6 axes, 1000 shocks				
Vibration (DIN EN 60068-2-6)	10 ... 38 Hz ±5 mm / 38 ... 500 Hz ±20 g per axis, 10 cycles				
Protection class (DIN EN 60529)	IP67 (casting) <sup>4)</sup>			IP20 (partial casting)	
Material	PA 6.6 / brass / PUR				
Weight	approx. 15 g	approx. 15 g	approx. 15 g	approx. 10 g	-
Features	-				
Min. order quantity	-			-	configurable
Packaging unit	1 pc.			10 pc.	from 200 pc
					selectable

FSO = Full Scale Output

<sup>1)</sup> Measuring range changes by using other magnets (see catalog p.18); external magnetic fields and/or ferromagnetic material in the measuring range of the sensor system affect the sensor characteristic line and the technical data.

<sup>2)</sup> Deviation to the regression curve according to the method of least squares; <sup>3)</sup> Peak-Peak; external first-order low pass; frequency response 5 kHz

<sup>4)</sup> For plug versions only in plugged and screwed condition; <sup>5)</sup> Connection cable see accessories

**Option SA8**

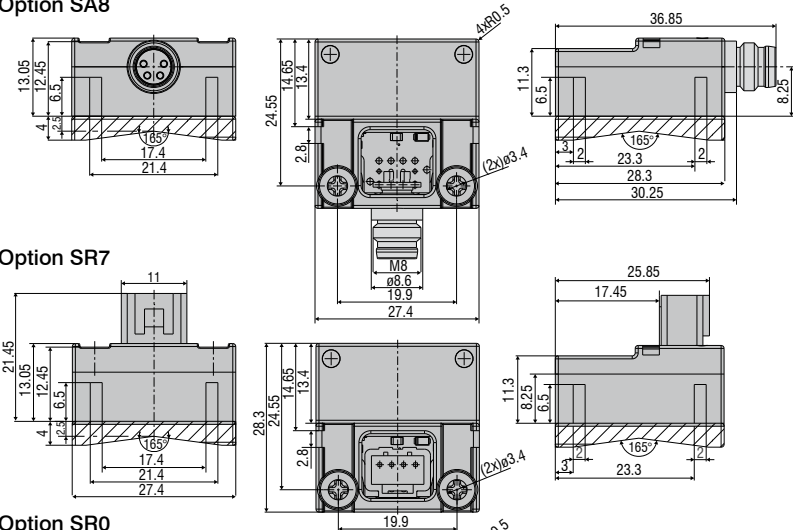

**Sensor signal**

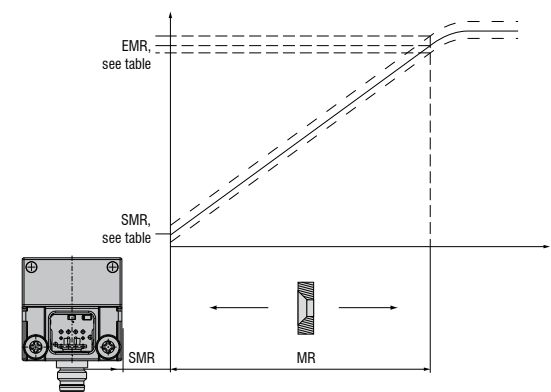

MR = Measuring range, SMR = Start of measuring range, EMR = End of measuring range

MDS-40-MK	SMR	EMR
-SA8-I	4 mA ±0.8 mA	19.2 mA ±0.8 mA
-SR7-U10	2 V ±0.4V	9.6 V ±0.4 V
-SR7-U45R	0.5 V ±0.2 V	4.5 V ±0.2 V
-MK-SR0-F	402 Hz ±6 Hz	285 Hz ±6 Hz

(Dimensions in mm, not to scale)

Optional retaining plate not included in delivery



MDS-40-D18-SA sensors are industrial-grade, magneto-inductive sensors with optimized price/performance ratio. These stand out due to the common characteristics of this product series and also because of their robust standard housing designed for clamp fastening.

The stainless steel housing protected to IP67 is ideal for demanding environments (dirt, oil, chemicals) and the food industry.

#### MDS-40-D18-SA

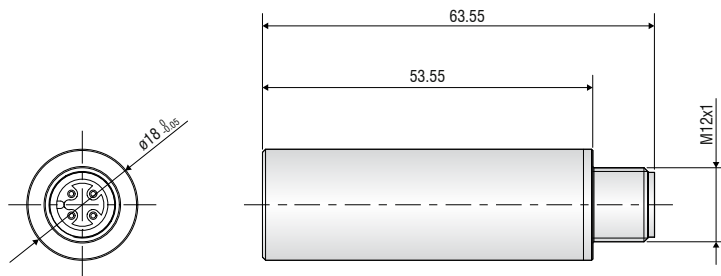

(Dimensions in mm, not to scale)

Model	MDS-40-D18-SA	
Measuring range <sup>1)</sup>	RL21 magnet: 30 mm (for other measuring ranges see page 18)	
Magnet included in delivery	-	
Start of measuring range <sup>1)</sup>	Magnet RL21: 1.5 mm	
Resolution <sup>3)</sup>	Voltage	0.05 % FSO
	Current	0.2 % FSO
Linearity <sup>1) 2)</sup>	≤ ±5 % FSO	
Repeatability	Voltage	≤ ±0.05 % FSO
	Current	≤ ±0.2 % FSO
Frequency response (-3dB)	1000 Hz	
Temperature stability	≤ 500 ppm FSO/K	
Supply voltage	11.5 ... 30 VDC	
Max. current consumption	20 mA (with voltage output); 42 mA (with current output)	
Analog output	Voltage	2 ±0.4 ... 9.6 ±0.4 V
	Current	4 ±0.8... 19.2 ±0.8 mA
Connection	Supply/signal: M12 screw/plug connection 4-pin, axial output <sup>5)</sup>	
Mounting	Clamping	
Temperature range	Storage	-20 ... +80 °C
	Operation	-20 ... +80 °C
Shock (DIN EN 60068-2-27)	40 g / 6 ms, 1000 shocks / 100 g, 6 ms, 3 shocks	
Vibration (DIN EN 60068-2-6)	10 ... 58 Hz ±1.5 mm / 58 ... 500 Hz ±20 g per axis, 10 cycles	
Protection class (DIN EN 60529)	IP67 <sup>4)</sup>	
Material	Stainless steel 1.4404, nickel-plated brass on request	
Weight	approx. 55 g	
Features	-	

FSO = Full Scale Output

<sup>1)</sup> Measuring range changes by using other magnets (see catalog p.18); external magnetic fields and/or ferromagnetic material in the measuring range of the sensor system affect the sensor characteristic line and the technical data.

<sup>2)</sup> Deviation to the regression curve according to the method of least squares

<sup>3)</sup> Peak-Peak; external first-order low pass; frequency response 5 kHz

<sup>4)</sup> For plug versions only in plugged and screwed condition

<sup>5)</sup> Connection cable see accessories

## Sensor signal

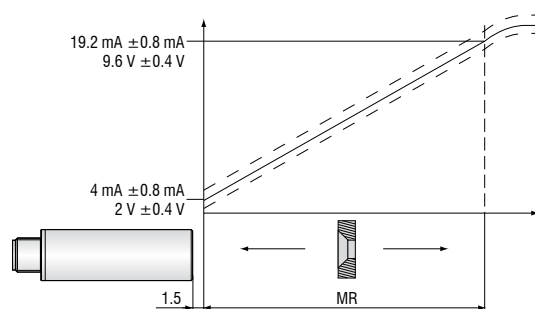

MR = Measuring range

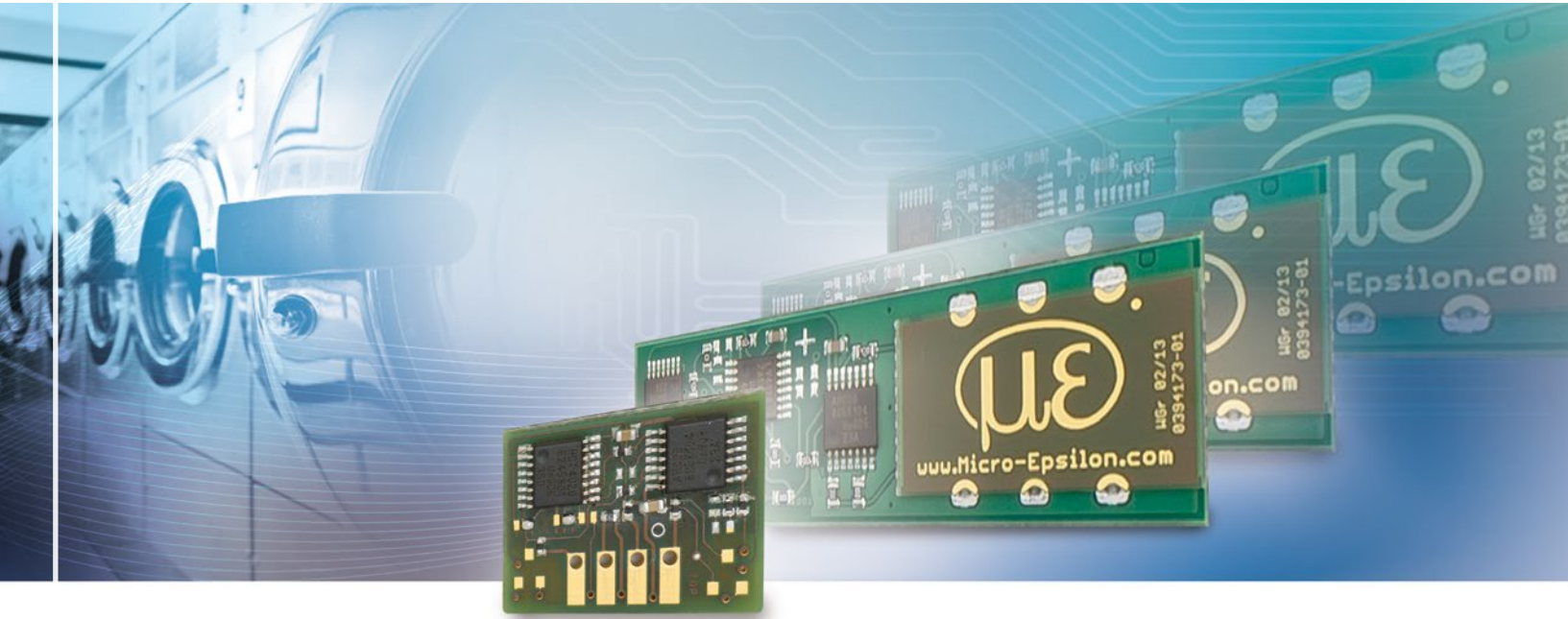

The MDS-40-LP sensors are specially designed for large scale production from 2,000 pieces. As these sensors are reduced to pure measurement technology, the creation of cost-effective PCB sensors was possible. Their flat design and flexible arrangement of the magnets enable easy integration in restricted spaces. Measured values are output via a rectangular signal, which is easily evaluated via, for example, digital inputs from micro-controllers.

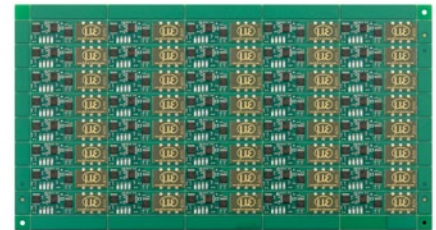

Model	MDS-40-LP-SUS	MDS-40-LP-F
Measuring range <sup>1)</sup>	40 mm	40 mm
Magnet included in delivery	-	-
Resolution <sup>2)</sup>	0.05 % FSO	0.05 % FSO
Linearity <sup>1) 2)</sup>	≤ ±6 % FSO	≤ ±9 % FSO
Repeatability		≤ 0.05 % FSO
Temperature stability	≤ 0.06 % FSO / K	≤ 0.2 % FSO / K
Supply voltage		3.6 ... 5.3 VDC
Max. current consumption		typ. 15 mA (5 VDC); 12 mA (3.6 VDC)
Analog output	Period duration (rectangle): typ. 2.0 ms ... 3.3 ms (p.19)	Period duration (rectangle): typ. 1.0 ... 1.7 ms (p.19)
Connection	Supply/signal: plug-in connection to a PCB or solder pads; grid size 2.5 mm	
Temperature range	Storage	-20 ... +85 °C
	Operation	-20 ... +85 °C
Weight	approx. 4.5 g	approx. 1.5 g
Features	Sensor module for integration: EMC & ESD protection and voltage stabilization must be provided externally if required.	
Min. order quantity	2,000 pc.	5,000 pc.

FSO = Full Scale Output

<sup>1)</sup> Measuring range changes by using other magnets (see catalog p.18); external magnetic fields and/or ferromagnetic material in the measuring range of the sensor system affect the sensor characteristic line and the technical data.

<sup>2)</sup> Deviation to the regression curve according to the method of least squares

<sup>3)</sup> Without reverse polarity protection, without overvoltage protection



Application example:  
Integration into a washing machine damper

### Sensors for customer-specific requirements

If necessary, the sensors can be individually adapted to the customers' requirements. Particularly in the case of high volume orders, customized sensors can be produced efficiently, which results in considerable cost reductions.

The compact PCB which contains the sensor element and the evaluation electronics is responsible for the signal preparation, signal evaluation and signal output. The type of measurement (distance or rotational speed measurement) and the required frequency response are adaptable. In addition, the interfaces offer numerous connectivity options. There are several outputs such as current, voltage, PWM and further digital outputs.

The design of the housing, the material and the protection class can be adapted to the specific requirements. In cases where space is limited, the side shifted measurement offers a space-saving alternative. For harsh environments, the sensor is designed with a fully sealed stainless steel housing that withstands high pressure, dirt, aggressive chemicals (acids) and solvents.

### Customer-specific solutions at a glance

- High cost efficiency with serial production
- Ideal for miniature applications
- Flexible design (sensor on PCB)
- Laterally displaced measurement arrangement (damper arrangement)
- Output signal (current, voltage, frequency...)
- Increased pressure resistance
- Frequency response up to 20 kHz



The PCB can be easily integrated and modified for customer-specific solutions – even in limited spaces.

### Customer-specific modification even for rotational speed measurement with magnetically biased sensors

For rotational speed measurements of ferromagnetic objects such as toothed racks, the sensor can be magnetically biased. This means that the magnet is integrated into the housing. For this customer-specific solution a factory calibration is required. The movement of the toothed racks affects the magnetic field, which is required for the speed measurement. Here, the measuring range is reduced from 6 mm to 7 mm. The speed measurement can also be carried out through non-ferromagnetic materials.

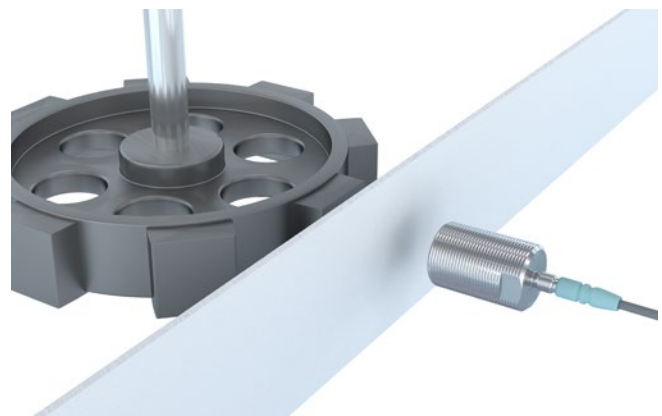

Magnetically biased sensor for speed measurement of toothed racks

**Accessories****Supply and output cables for solid metal sensors**

- Art.No. 2901617 PC5/4 (5 m, shielded, straight connector, M8x1, PUR, open ends)  
 Art.No. 2901600 PC5/4/90 (5m, shielded, angle plug, M8x1, PUR, open ends)

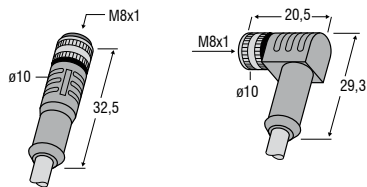
**Power and output cable for sensors made from plastics**

- Art.No. 2901599 PC5/4(01) (5 m, unshielded, straight connector, M8x1, PUR, open ends)  
 Art.No. 2901600.01 PC5/4/90(01) (5 m, unshielded, angle plug, M8x1, PUR, open ends)

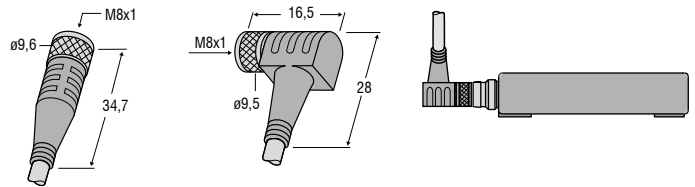
**Supply and output cable**

- Art.No. 29011154 PC5/5-IWT (5 m, shielded, straight connector, M12x1, PVC, open ends)

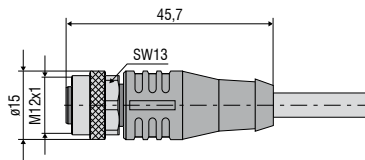
**Supply and output cable**

- Art.No. 29011212 PC5/5-HT-IWT (5 m, shielded, straight connector, M12x1, PTFE (up to 260 °C, open ends)

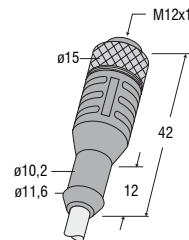
**Supply and output cable**

- Art.No. 29011102 PC1/4-SR0 (1 m, single strands, PVC, JST PA connector, open ends)

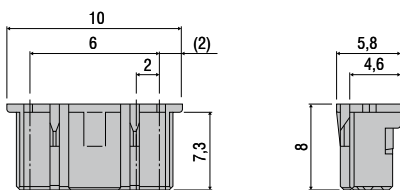
**Supply and output cable**

- Art.No. 29011101 PC1/4-SR7 (1 m, single strands, PVC, JST JWPF connector, open ends)

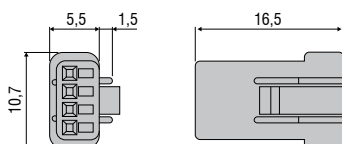



**Pin assignment M8x1**

Pin	Description
1	Supply voltage
2	Output signal 4 mA ... 20 mA / n.c.
3	GND
4	Output signal 2 V ... 10 V
Shield	connect shield to the ground <sup>1)</sup>

1) With metal sensors connected to housing

**Pin assignment**  
View on connector side

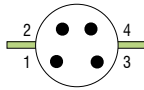

**Pin assignment M8x1 (SA8)**

Pin	Description
1	Supply voltage
2	GND Out
3	GND supply
4	+ Out
GND pins internally connected	

**Pin assignment**  
View on connector side

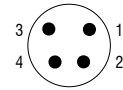

**Pin assignment M12x1**

Pin	Description
1	Supply voltage
2	Output signal 4 mA ... 20 mA / n.c.
3	GND
4	Output signal 2 V ... 10 V
Shield	connect shield to the ground <sup>1)</sup>

1) With metal sensors connected to housing

**Pin assignment**  
View on connector side

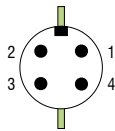

**Pin assignment JST JWPF (SR7)**

Pin	Description
1	Supply voltage
2	GND Out
3	GND supply
4	+ Out
GND pins internally connected	

**Pin assignment**  
View on connector side

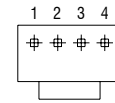

**Pin assignment CA**

Pin	Color	Color HT	Description
1	brown	red	Supply voltage
2	white	-	Output signal 4 mA ... 20 mA / n.c.
3	blue	blue	GND
4	black	black	Output signal 2 V ... 10 V
Shield			connect shield to the ground <sup>1)</sup>

1) With metal sensors connected to housing

**Pin assignment JST PA (SR0)**

Pin	Description
1	Supply voltage
2	GND Out
3	GND supply
4	+ Out
GND pins internally connected	

**Pin assignment**  
View on connector side

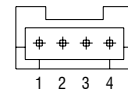

**Pin assignment PC5/4**

Pin	Color
1	brown
2	white
3	blue
4	black
Shield	

**Pin assignment**  
View on connector side

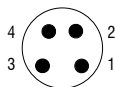

**Pin assignment PC5/5**

Pin	Color
1	brown
2	white
3	blue
4	black
5	gray
Shield	

**Pin assignment**  
View on connector side

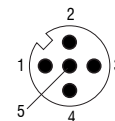

**Magnets**

The magnets are critical components of the magneto-inductive measuring principle.

Many shapes and materials are available. Application, installation space, temperature and cost factors must be considered. A decisive advantage is that the measuring range of the sensor can be defined by selecting the appropriate magnet. Adapting or set up of the sensor are unnecessary.

Therefore, measuring ranges of 20 to 55 mm can be achieved using only one sensor.

Simple change of the measuring range by exchanging the magnet (MDS-45)

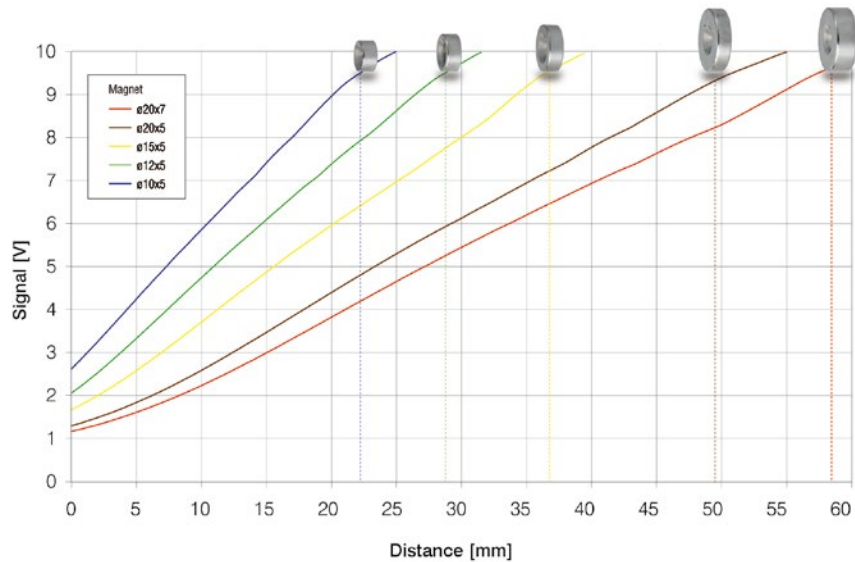

Designation	Measuring range MDS-45 [mm]	Measuring range MDS-35 HT [mm]	Measuring range MDS-40-MK [mm]	T <sub>max</sub> [°C]	Standard magnets				Standard magnets in pressure housing						
					Material	d	D1	D2	H	Material	d	H	L	M	S
MB20	20	14	-	150	NeFeB, nickel-plated	10	4.3	8.6	5	1.3964 Nitronic 50HS	16	9.5	5	M4	2
MB27	27	18	~ 23	150	NeFeB, nickel-plated	12	4.3	8.6	5	1.3964 Nitronic 50HS	16	9.5	5	M4	2
MB35	35	24	~ 33	150	NeFeB, nickel-plated	15	4.3	8.6	5	1.3964 Nitronic 50HS	26	14	7	M6	3.5
MB45	45	32	~ 45	150	NeFeB, nickel-plated	20	4	8	5	1.3964 Nitronic 50HS	26	14	7	M6	3.5
MB55	55	38	~ 50	150	NeFeB, nickel-plated	20	4	8	7	1.3964 Nitronic 50HS	26	14	7	M6	3.5
RL21	33	22	~ 30	200	SrFe, hard ferrite	20	4.3	-	10	-	-	-	-	-	-
RL20	25	12	~ 25	200	SrFe, hard ferrite	20	4.3	-	6.5	-	-	-	-	-	-
MB35HT	52	35	-	250	Sm2Co5	22	5.2	10.4	6	-	-	-	-	-	-

**Magnets at higher temperatures**

Permanent magnets present reversible and irreversible temperature dependence. With low temperatures, the magnetic field changes reversibly with the temperature. In the first approximation, this dependence is linear. Irreversible attenuations of the magnetic field are caused by rising temperatures. The main part of these attenuations arises when the temperature is reached for the first time. Therefore, it is recommended that when using magnets in high temperatures, they are heated up only once to the operating temperature or to around 20 °C above the operating temperature, provided that the respective magnet specification allows this.

Please refer to Micro-Epsilon TechNote T016 for further details.

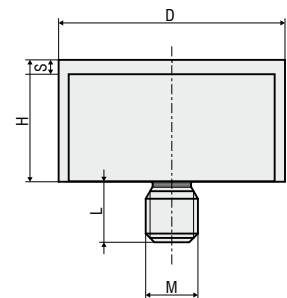
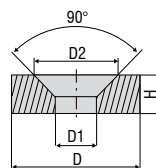

A pressure housing is a method of protecting a magnet from high pressure or aggressive media. This is made from robust stainless steel and resists pressures up to 400 bar.

**Rectangular output signals**

Effective sensor technology is indispensable with OEM sensors in order to achieve an optimal price/performance ratio. Therefore, many MDS-40 sensors operate based on a rectangular output signal which can be easily generated and evaluated, e.g., via the digital input of a micro-controller. Depending on the type of magnet, the distance signal is proportional to the period of duration or the frequency of the rectangular signal.

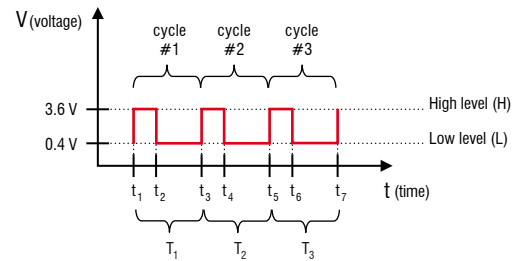

**MDS-40-LP-F series**

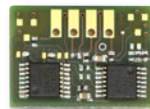
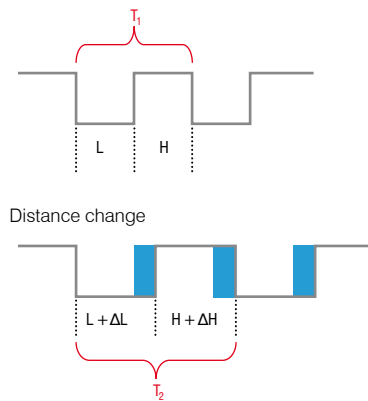

L = time at a low level  
H = time at a high level  
H and L ~ distance signal

**MDS-40-LP-SUS series**

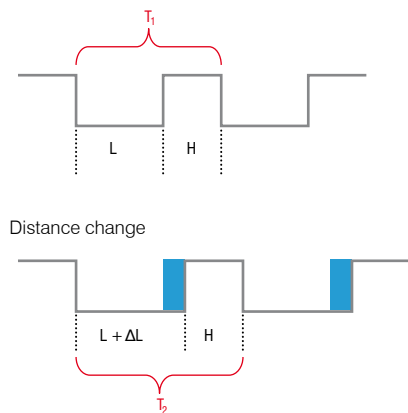

L = time at a low level  
H = time at a high level  
L ~ distance signal  
Details about temperature compensation are available on request

**MDS-40-MK series**

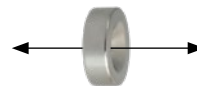
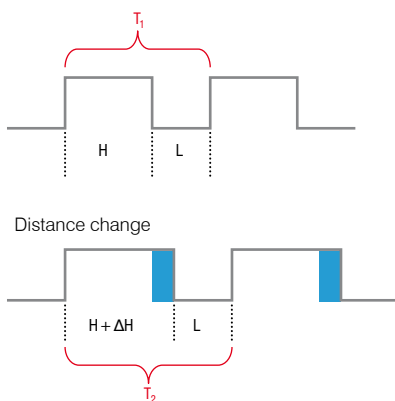

L = time at a low level  
H = time at a high level  
 $1/(H+L) = f \sim$  distance signal

## Sensors and Systems from Micro-Epsilon



Sensors and systems for displacement, distance and position



Sensors and measurement devices for non-contact temperature measurement

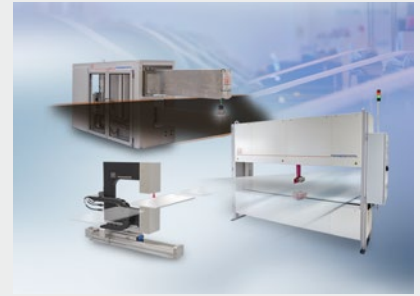

Measuring and inspection systems for metal strips, plastics and rubber



Optical micrometers and fiber optics, measuring and test amplifiers



Color recognition sensors, LED analyzers and inline color spectrometers

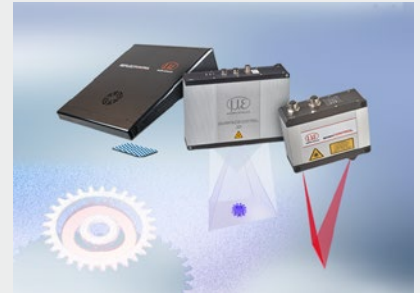

3D measurement technology for dimensional testing and surface inspection