

SENSORS & SYSTEMS

Authority in Displacement Measuring

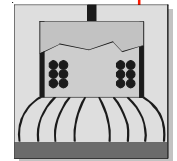

INSTRUCTION
MANUAL



Non-contact eddy-current
displacement and position
measurement

Instruction Manual
eddyNCDT 3700

**MICRO-EPSILON
MESSTECHNIK**

GmbH & Co. KG
Koenigbacher Strasse 15

D-94496 Ortenburg

Tel. +49/85 42/1 68-0
Fax +49/85 42/1 68-90
e-mail info@micro-epsilon.de
www.micro-epsilon.com



Certified acc. to DIN EN ISO 9001: 2000

Content

1.	Safety	5
1.1	Symbols Used	5
1.2	Warnings	5
1.3	Notes on CE Identification	6
1.4	Proper Use	7
1.5	Proper Environment	7
2.	System Description	8
2.1	Measurement Principle	8
2.2	Structure of the Measurement System	8
2.3	Glossary	10
2.4	Technical Data	12
3.	Delivery	14
3.1	Supplied Items, Unpacking	14
3.2	Storage	14
4.	Installation and Assembly	15
4.1	Precautions	15
4.2	Sensor	15
4.2.1	Start of Measuring Range	16
4.2.2	Standard Mounting	17
4.2.3	Flush Mounting	18
4.3	Sensor Cable	19
4.4	Controller	19



4.5	Connecting the Measurement System	20
4.5.1	Power Supply and Reverse Voltage Protection	20
4.5.2	Signal Output	21
4.5.2	Sensor	22
5.	Operation	22
5.1	Zero and Gain	22
5.2	Differential system DT3703	24
6.	Warranty	26
7.	Appendix.....	27

1. Safety

1.1 Symbols Used

Knowledge of the operating instructions is a prerequisite for equipment operation. The following symbols are used in this instruction manual:



DANGER! - **imminent danger**



WARNING! - **potentially dangerous situation**



IMPORTANT! - **useful tips and information**

1.2 Warnings

- Avoid **banging** and **knocking** the sensor and/or the controller
 - ⇒ Damage to or destruction of the sensor and/or the controller
- The **power supply** may not exceed the specified limits
 - ⇒ Damage to or destruction of the controller and/or the sensor
 - ⇒ Danger of injury
- **Power supply** and the **display-/output** device must be connected in accordance with the safety regulations for electrical equipment
 - ⇒ Danger of injury
 - ⇒ Damage to or destruction of the sensor and/or the controller
- Protect the **sensor cable** against damage
 - ⇒ Destruction of the sensor and/or the controller
 - ⇒ Failure of the measuring device



1.3 Notes on CE Identification

The following applies to the eddyNCDT series 3700:

EC regulation 89/336/EEC

Products which carry the CE mark satisfy the requirements of the EC regulation EC 89/336/EEC 'Electromagnetic Compatibility' and the European standards (EN) listed therein. The EC declaration of conformity is kept available according to EC regulation, article 10 by the authorities responsible at

MICRO-EPSILON MESSTECHNIK
GmbH & Co. KG
Koenigbacher Straße 15
94496 Ortenburg

The eddyNCDT series 3700 measuring system is designed for use in industry and satisfy the requirements of the standards

- EN 61000-6-3 RFI emission
- EN 61000-6-2 Immunity to interference

The eddyNCDT series 3700 measuring system satisfies the requirements if the system is operated according to the regulations described in the operating manual for installation and operation.



1.4 Proper Use

- The eddyNCDT series 3700 measuring system is designed for use in industrial areas.
- It is used for
 - displacement, distance, thickness and movement measurement
 - position measuring of parts or machine components
- The measuring system may only be operated within the limits specified in the technical data.
- The system should only be used in such a way that in case of malfunction or failure personnel or machinery are not endangered.
- Additional precautions for safety and damage prevention must be taken for safety-related applications.

1.5 Proper Environment

- Temperature: -50 to +150 °C (-58 to +302 °F) sensor and cable
 +10 to +60 °C (+50 to +140 °F) controller
- Humidity: 5 - 95 % (no condensation)
- Ambient pressure: atmospheric pressure
- EMC: According to EN 61000-6-3 RFI emission
 EN 61000-6-2 Immunity to interference
- Storage temperature: -50 to +150 °C (-58 to +302 °F) sensor and cable
 -25 to +75 °C (-13 to +167 °F) controller
- Vibration/Shock: EN 60068-2

2. System Description

2.1 Measurement Principle

The eddyNCDT 3700 (Non-Contacting Displacement Transducers) measurement system operates on the basis of eddy currents without making physical contact. It is used for measurements on objects consisting of electrically conducting materials with non-ferromagnetic properties.

High frequency alternating currents flow through a coil cast in a sensor housing. The electromagnetic field from the coil induces eddy currents in the electrically conducting measurement object, causing the alternating current resistance of the coil to change. This change of impedance delivers an electrical signal proportional to the distance of the measurement object from the sensor.

2.2 Structure of the Measurement System

The non-contact displacement measurement system consists of:

- sensor
- sensor cable
- controller
- signal cable
- power supply.

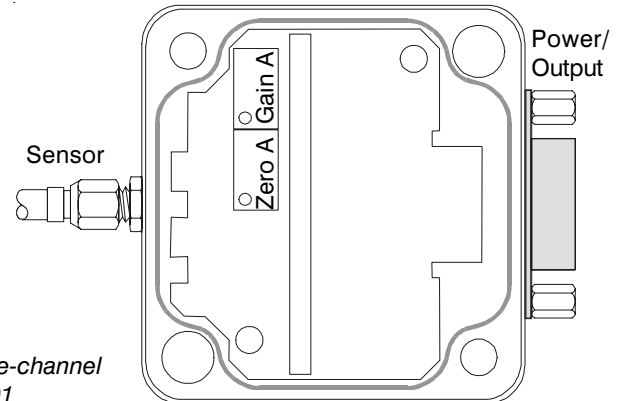

Fig. 2.1: Single-channel system DT3701

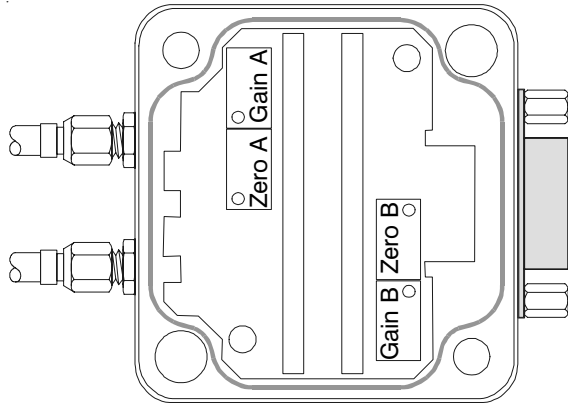

Fig. 2.2: Dual-channel system DT3702

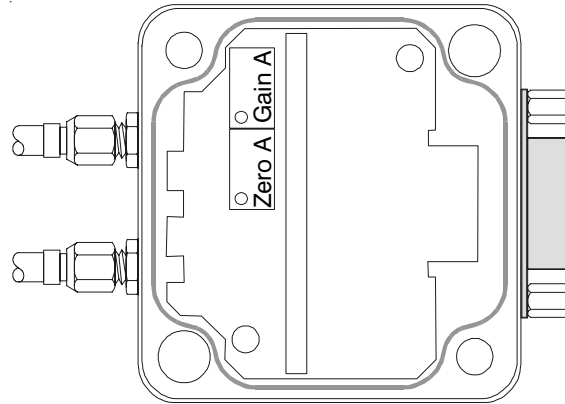

Fig. 2.3: Differential system DT3703

This system permits three basic alternative versions to be selected.

- Single-channel mode
- Dual-channel mode and
- Differential mode.

In the dual-channel system the two channels operate independently of one another.

In differential mode, two sensors are operated on a single measuring electronics system. At the output the controller delivers the difference between the sensor A signal minus the sensor B signal.



If the sensor is replaced by another of the same type or if the sensor cable is replaced:

- check calibration and, if necessary, recalibrate the measuring channel (see Chapter 5.1).

If the sensor is replaced by another of a different type, the length of the sensor cable is changed or the non-ferromagnetic measurement object material is changed:

- check calibration and, if necessary, recalibrate the measuring channel (see Chapter 5.1).

2.3 Glossary

SMR Start of measuring range. Minimum distance between the sensor front and the object to be measured.

MMR Midrange

EMR End of measuring range (Start of measuring range + measuring range).

Maximum distance between the sensor front and the object to be measured.

MR Measuring range

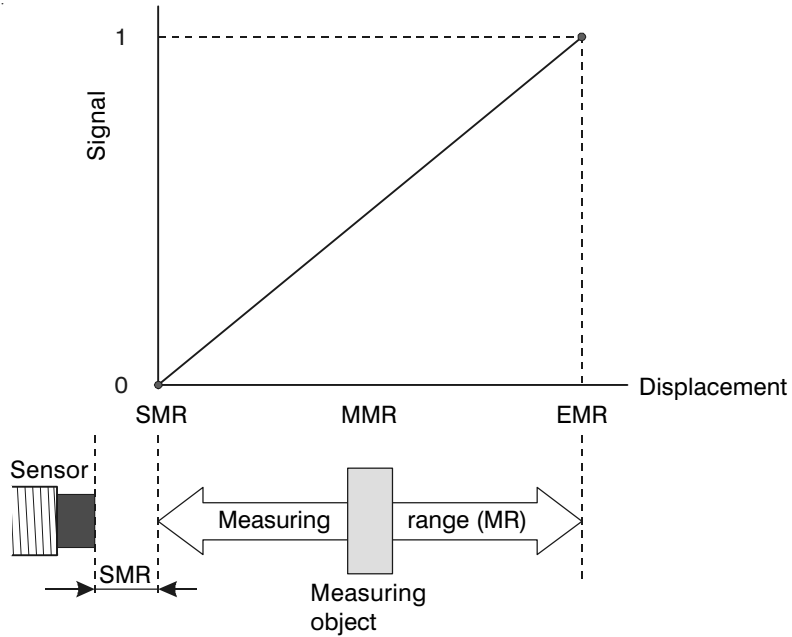

Fig. 2.4: Definition of terms

2.4 Technical Data

	Model	Single-channel system			Dual-channel system			Differential system		
		DT3701-U1-A-C3	DT3701-U3-A-C3	DT3701-U6-A-C3	DT3702-U1-A-C3	DT3702-U3-A-C3	DT3702-U6-A-C3	DT3703-U1-A-C3	DT3703-U3-A-C3	DT3703-U6-A-C3
Measuring range MR ¹	mm	1	3	6	1	3	6	0.5	1.5	3
Start of measuring range SMR	mm	0.1	0.3	0.6	0.1	0.3	0.6	0.1	0.3	0.6
Sensor type ²		U1	U3	U6	U1	U3	U6	U1	U3	U6
Measuring principle		non-contact eddy-current principle								
Measurement target		non ferromagnetic metal (reference: aluminium)								
Linearity		±6 % FSO						±5 % FSO		
Repeatability		< 0.001 % FSO						< 0.0005 % FSO		
Resolution (static) @RMS, fg = 10 Hz	nm	0.2	0.77	2	0.2	0.77	2	0.09	0.22	0.45
		< 0.000033 % FSO						< 0.000018 % FSO		
Resolution (dynamic) @RMS, fg = 1 kHz	nm	1.3	3.9	9.8	1.3	3.9	9.8	0.4	1	2.1
		< 0.00016 % FSO						< 0.00008 % FSO		
Frequency response (-3 dB)		10 kHz								

System Description



		Single-channel system			Dual-channel system			Differential system		
		DT3701-U1-A-C3	DT3701-U3-A-C3	DT3701-U6-A-C3	DT3702-U1-A-C3	DT3702-U3-A-C3	DT3702-U6-A-C3	DT3703-U1-A-C3	DT3703-U3-A-C3	DT3703-U6-A-C3
Operating temperature	Controller	+10 ... +60 °C (+50 ... +140 °F)								
	Sensor + cable	-50 ... +150 °C (-58 ... +302 °F)								
Storage temperature	Controller	-25 ... +75°C (-13 ... +167 °F)								
	Sensor + cable	-50 ... +150 °C (-58 ... +302 °F)								
Temperature stability (Midrange)		Controller ≤ 0.025 % FSO/°C								
		Sensors								
	% FSO/°C	≤ 0.05	≤ 0.06	≤ 0.19	≤ 0.05	≤ 0.06	≤ 0.19	≤ 0.025	≤ 0.015	≤ 0.06
Sensor cable length	3 m ± 0.45 m (10 ft ±1.5 ft)									
Signal output	0 ... 2.5 V / -2.5 ... 10 V (Impedance: 100 Ohm) Option I: 4 ... 20 mA (Load: see Chap. 4.5.2)									
Power supply	8 ... 30 VDC / 30 mA			8 ... 30 VDC / 50 mA			8 ... 30 VDC / 30 mA			

All data apply for aluminium at 20 °C, FSO = Full Scale Output,

- 1) Measuring ranges for OEM applications on request
- 2) Sensor models for OEM applications on request (more than 500 different sensor models are available)
- 3) -2.5 ... 0 V / -2.5 ... 2.5 V / -2.5 ... 5 V / -2.5 ... 10 V / 0 ... 2.5 V / 0 ... 5 V / 4 ... 20 mA for OEM applications on request

3. Delivery

3.1 Supplied Items, Unpacking

Check for completeness and shipping damages immediately after unpacking. The delivery includes:

	DT3701	DT3702	DT3703
Sensor	1	2	
Sensor cable	1	2	
Test log	1		
Controller	1		
Instruction manual	1		

If any item has been damaged or omitted, please contact MICRO-EPSILON or your supplier immediately.

3.2 Storage

Storage temperature

Sensor and cable: -50 ... 150 °C (-58 ... +302 °F)

Controller: -25 ... 75 °C (-13 ... +167 °F)

Humidity: 5 - 95 % (non-condensing)

4. Installation and Assembly

4.1 Precautions

No sharp or heavy objects should be allowed to affect the cable sheath of the sensor cable, the supply cable and of the output cable. All plug-in connections must be checked for firm seating before starting operation.

4.2 Sensor

Unscreened sensors (Fig. 4.1)

- Type designation: U..
- Construction: The front part of the sensor with encapsulated coil consists of electrically non-conducting materials.
- Important: In the radial direction metal parts in the vicinity may behave similar to the measurement object, rendering the measurement result inaccurate.



Fig. 4.1: Unscreened sensor

4.2.1 Start of Measuring Range

For each sensor a minimum distance to the measurement object must be maintained. This avoids a measurement uncertainty due to the sensor pressing on the measurement object and mechanical damage to the sensor/measurement object.



Abb. 4.2: Start of measuring range (SMR), the smallest distance between sensor face and measuring object.

Sensor	Start of measuring range SMR	Mounting thread M	
U1	0.1	M5x0.8	
U3	0.3	M12x1	
U6	0.6	M18x1	

Eddy-current displacement sensors can be affected in their measurement properties by a metallic holder. Depending on the sensor type, the following sensor mounting should be preferred:

- unscreened sensors: Standard mounting.
- screened sensors: Flush mounting.

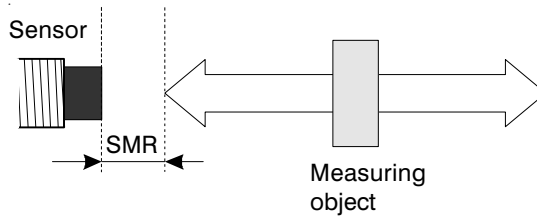
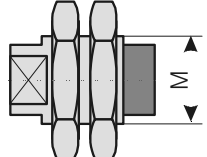
4.2.2 Standard Mounting

The sensors protrude beyond the metal holder.

- Insert the sensor through the hole in the sensor holder.
- Screw the sensor tight, turning the mounting nuts on both sides on the thread protruding from the holder. Tighten carefully to avoid damage, particularly to smaller sensors.

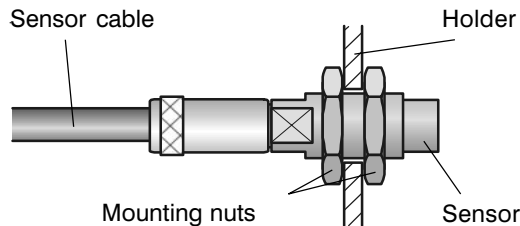

Fig. 4.3: Unscreened sensor with thread in standard mounting.

IMPORTANT!

The standard mounting of the sensor should be preferred, because the optimum measurement results can be achieved with this method.

IMPORTANT!

During calibration maintain the same relative position of the sensor to the holder as for the measurement.

4.2.3 Flush Mounting

- Mount the sensors flush in a sensor holder of insulating material (plastic, ceramic, etc.) or
- Mount the sensors flush in a metal sensor holder, making sure that a recess of a size three times the sensor diameter is used.
- In all mounting cases screw the sensor into the threaded hole and lock it with the mounting nut. Tighten carefully to avoid damage, particularly to smaller sensors.



IMPORTANT!

Calibrate the measurement system in the measurement arrangement with the original mounted sensor.

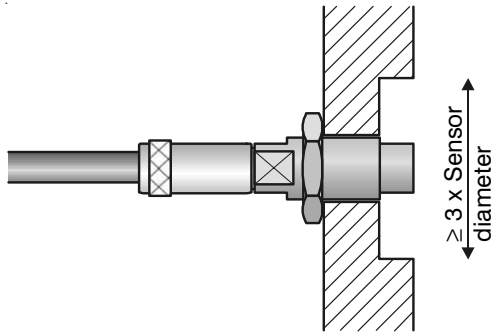

Fig. 4.4: Flush mounting of an unscreened sensor in a metal holder.



4.3 Sensor Cable

- Do not kink the cable - the minimum bending radius is 39 mm.
- Lay the cable such that no sharp-edged or heavy objects can affect the cable sheath.
- Make the connection between the sensor and controller using the sensor cable (type C...). Connect the sensor cable to the controller (see Fig. 4.5). Check the plugged connections for firm seating.

4.4 Controller

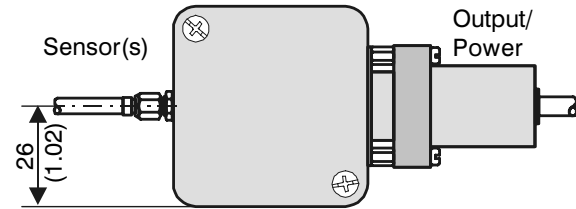
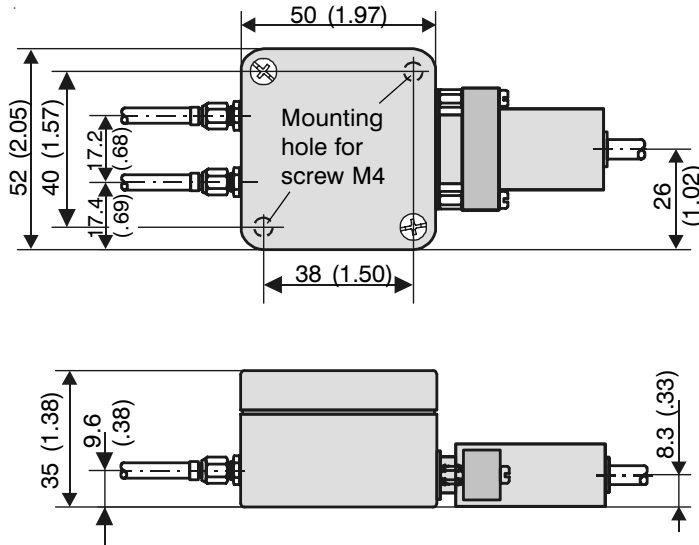

i IMPORTANT!

In pressurized areas protect the cable from pressurization.

Legend:
mm
(inches)

Fig. 4.5: Dimensions and mounting method for controller, not to scale.

i IMPORTANT!

The power supply PS2010 is available as an accessory.

4.5 Connecting the Measurement System

4.5.1 Power Supply and Reverse Voltage Protection

The electronics are supplied with voltage which must not fall outside the range of 8 - 30 VDC. The minimum supply voltage is always dependent on the maximum output voltage pre-set at the factory (see Tab. 4.1). For short periods a maximum of 35 VDC is permitted. The negative supply voltage and reference voltage is self-generated by means of a charge pump.

If the controller is run at the lowest supply voltage limit this will reduce the power loss-based heating up of the electronic system and will reduce its warm-up time.

U_{OUT} SMR, ex factory	U_{OUT} EMR, ex factory	U_{SUPPLY} min.
-2.5 VDC	0 VDC	8 VDC
-2.5 VDC	+2.5 VDC	8 VDC
-2.5 VDC	+5 VDC	8.7 VDC
-2.5 VDC	+10 VDC	12.5 VDC
0 VDC	+2.5 VDC	8 VDC
0 VDC	+5 VDC	8.7 VDC
0 VDC	+10 VDC	12.5 VDC

Tab. 4.1: Minimum supply voltage in dependency on output voltage pre-set at the factory.

The terminals for the supply voltage (pins 1 and 3 on the sub-D connector, Fig. 4.6) come with an internal connection to a reverse voltage protection diode. If the supply voltage should be incorrectly connected, therefore, it will be short-circuited by the diode. The electronics will not suffer any damage from incorrect poling as long as the short-circuit current does not exceed 1 A.

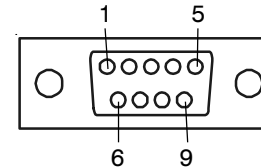

Fig. 4.6: 9-pole jack (sub-D) on the controller, viewed from the contact side.

Pin	Assignment	Colour PC370x
1	+ Supply	brown
2	Output B	yellow
3	Earth	white
4	Output A	green
5...9	internal connection	n.c.

Fig. 4.7: Pin assignment on the 9-pole jack (sub-D) of the controller



4.5.2 Signal Output

The output impedance for the voltage output is 100 Ohm. Channel isolation in the dual-channel system is ≥ 66 dB.

Tab. 4.2: Pin assignment for voltage output

	DT3701	DT3702	DT3703
Output A	Pin 4		
Output B	---	Pin 2	---
Ground	Pin 3		

Current output (optional)

A current output is also available as a an output alternative for the single-channel system and the differential system. This also requires the use of output "Out B" as well, however. Here it is imperative that the external load impedance (see Fig. 4.8) is not returned to ground, otherwise the internal operation amplifier will be missing the controlled variable.

When the maximum distance of the sensor is reached the power consumption of the electronics increases by approx. 28 mA. As a result, the total power consumption of the controller increases to approx. 55 mA.

If the sensor is disconnected or the object to be measured goes beyond the valid measuring range, there will be +5 or +10 V DC, subject to factory setting, at output "Out A". If the load impedance is very low the output currents will be higher in such a case (Tab. 4.3).

Output	$U_{OUT, max}$	R_{LOAD}	I_{OUT} $R_{LOAD, min.}$	I_{OUT} $R_{LOAD, max.}$
0 ... 20 mA	5 V	0 ... 120 Ohm	42 mA	20.8 mA
0 ... 20 mA	10 V	120 ... 360 Ohm	42 mA	20.8 mA
4 ... 20 mA	5 V	0 ... 110 Ohm	35 mA	20.7 mA
4 ... 20 mA	10 V	110 ... 350 Ohm	39 mA	20.7 mA

Tab. 4.3: Output current with disconnected sensor in dependency on R_{LOAD}



WARNING!

The voltage output(s) of the controller is/are not short-circuit-proof.



Abb. 4.8: External output circuit elements for current output



WARNING!

If the controller is operated for a longer period with
 - high supply voltage and
 - a disconnected sensor / an overshoot measuring range and
 - R_{LOAD}
 this will lead to power loss which will result in damaging the controller beyond repair.

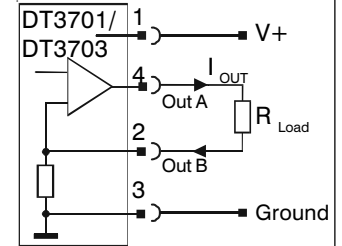
4.5.2 Sensor

The sensor, including the sensor cable, is connected to the SMC jack (see Fig. 2.1). The SMC jack and the sub-D connector are connected to ground potential.

5. Operation

Check that the measuring system is correctly set up.

- 1) Is the supply voltage connected?
- 2) Is the sensor connected?
- 3) Are the cable connections securely attached?

5.1 Zero and Gain

eddyNCDT measuring systems come with calibration provided at the factory. If the user changes either the sensor or the object to be measured (material, geometry), recalibration will be required before measurement is started again.

In doing so, use

- the original sensor mount and
- the original object to be measured wherever possible!

Calibration is carried out with reference to two spacing points specified by a control standard.

Two reference points:

- Start of the measuring range SMR (1)
- End of the measuring range EMR (2)

IMPORTANT!

If it is not possible to use the original object to be measured, the measuring environment should be simulated as precisely as possible!

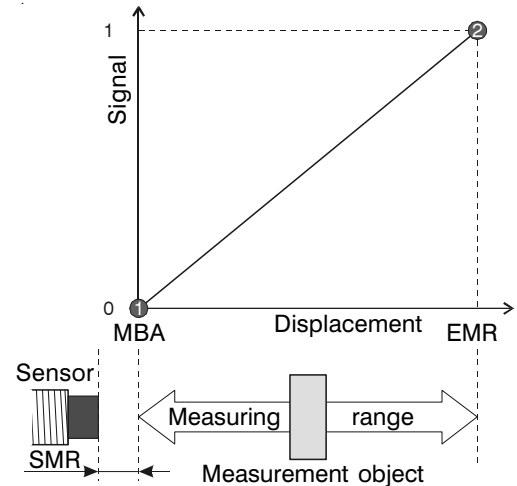

Fig. 5.1: eddyNCDT systems can be custom-set by means of 2-point calibration.

Operation

Calibration aids:

- 1) Special micrometer calibration device with non-rotating micrometer spindle (Fig. 5.2, available as an accessory), or
- 2) Ceramic spacer rings (reduces calibration accuracy!).

All measuring channels are tested before delivery.

Zero setting:

- Position the object to be measured at the start of the measuring range (SMR) relative to the sensor. The start of the measuring range will depend on the type of sensor (see Chapter 4.2.1).
- Use the zero potentiometer for channel A/B (Fig. 2.1 - 2.3) to set the value specified from the factory (voltage output: -2.5/0 VDC, or current output: 0/4 mA). Any deviating zero values will be influenced by the setting of the gain (gain potentiometer).

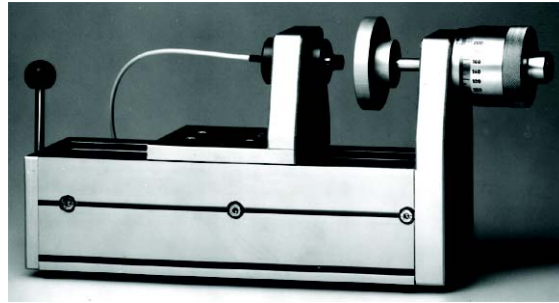

Fig. 5.2: Micrometer calibration device

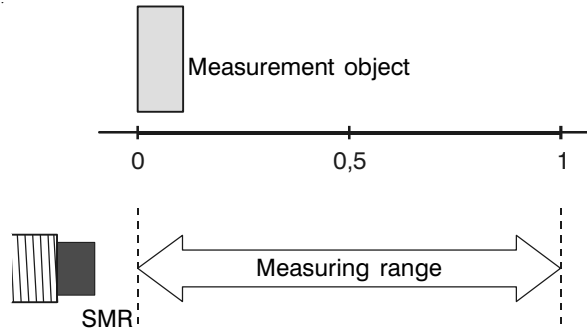

Fig. 5.3: Position of object to be measured at start of measuring range

i IMPORTANT!

Before carrying out any measurements or calibration the measuring device should be allowed to warm-up for approx. 30 minutes.

Gain setting:

- Position the object to be measured at the end of the measuring range (SMR) relative to the sensor.
- Use the gain potentiometer for channel A/B (Fig. 2.1 - 2.3) to set the desired value for the output voltage/current. The maximum output voltage cannot be set any higher than the maximum output voltage set at the factory.

If required, repeat the steps for zero/gain until the desired output characteristics have been achieved.

5.2 Differential system DT3703

Installation alternatives for the sensors

Sensor A measures the distance to the object to be measured.

Sensor B is set to a fixed reference distance.

Advantages: If the object to be measured and the control object have virtually identical temperatures and they are both at approx. the same distance from sensor A or sensor B, temperature compensation will be improved.

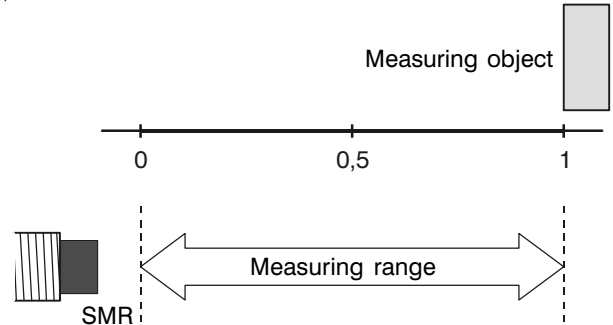
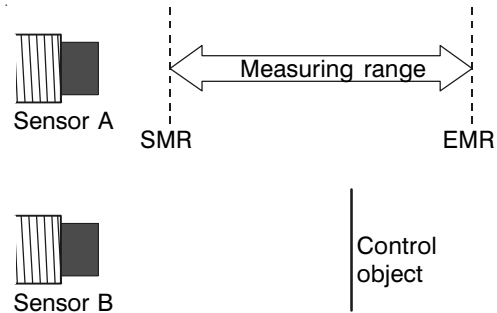

Fig. 5.4 Position of object to be measured at the end of measuring range

Installation alternative 1



Sensors A and B both measure the distance at the same time.

Installation alternative 2: Rotation

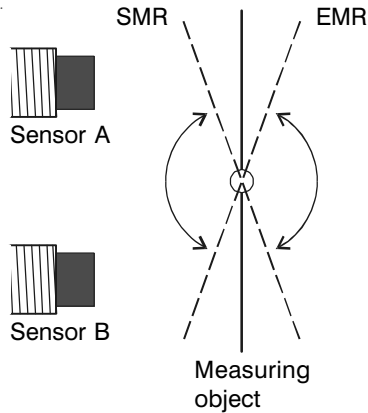

Installation alternative 3: Linear shift

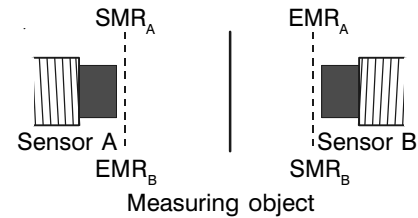

Advantages

- Sensitivity is doubled because both sensors measure the linear shift.
- Better linearity. If the measuring range is limited, linearity is $\pm 1\%$ FSO

Notes on sensor installation

If the position of the sensors when installed cannot be precisely fixed, make a note of the output signals of the sensors when at midrange (MMR). Then install sensor A (sensor B stays at MMR), move the object to be measured to MMR and adjust the position of sensor A until the output signal previously noted is reached. Then install sensor B and adjust its position until the output signal previously noted is reached.



6. Warranty

All components of the system have been checked and tested for perfect function in the factory.

In the unlikely event that errors should occur despite our thorough quality control, this should be reported immediately to MICRO-EPSILON.

The warranty period lasts 12 months following the day of shipment. Defective parts, except wear parts, will be repaired or replaced free of charge within this period if you return the device free of cost to MICRO-EPSILON.

This warranty does not apply to damage resulting from abuse of the equipment, from forceful handling or installation of the devices or from repair or modifications performed by third parties.

Repairs must be exclusively done by MICRO-EPSILON.

No other claims, except as warranted, are accepted. The terms of the purchasing contract apply in full.

MICRO-EPSILON will specifically not be responsible for eventual consequential damage.

MICRO-EPSILON always strives to supply its customers with the finest and most advanced equipment. Development and refinement is therefore performed continuously and the right to design changes without prior notice is accordingly reserved.

For translations in other languages, the data and statements in the German language operation manual are to be taken as authoritative.

7. Appendix

Sensor dimensions, not to scale

U1

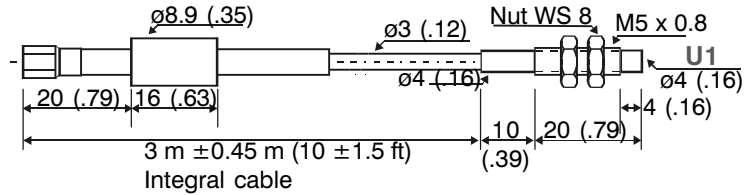

U3

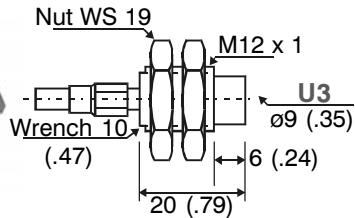

U6

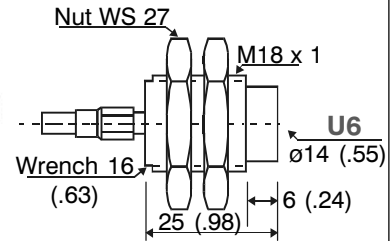

Legend:
mm
(inches)



MICRO-EPSILON

Sensor modell Unscreened U...		U1	U3	U6
Sensor weight without cable	g	1.5	7.5	22
Integral sensor cable	m	3	---	---

Tab. 7.1: Mass of sensors

Legend:
mm
(inches)

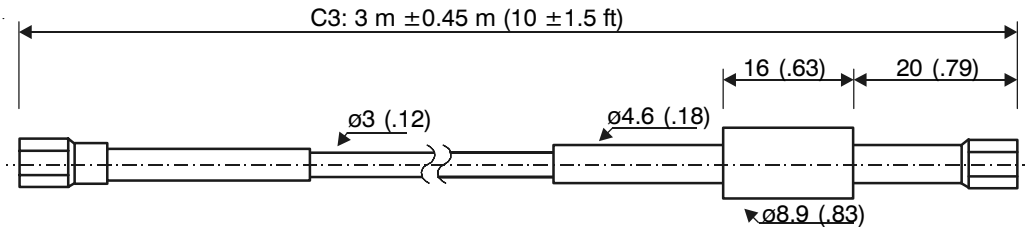

Sensor cable, Type C3