



Operating Instructions
capaNCDT 6500

CS005
 CS02
 CSH02
 CSH02FL
 CS05
 CSE05
 CSE05/M8
 CSH05

CSH05FL
 CS08
 CS1
 CSE1
 CSE1,25/M12
 CSH1
 CSH1FL
 CS1HP

CSH1.2
 CSH1.2FL
 CS2
 CSE2
 CSE2/M16
 CSH2
 CSH2FL
 CS3

CSE3/M24
 CSH3FL
 CS5
 CS10
 CSG0.50-CAM2.0
 CSG1.00-CAM2.0

MICRO-EPSILON
MESSTECHNIK
GmbH & Co. KG
Koenigbacher Str. 15

94496 Ortenburg / Germany

Tel. +49/8542/168-0
Fax +49/8542/168-90
e-mail info@micro-epsilon.com
www.micro-epsilon.com



EtherCAT® is registered trademark and patented technology, licensed by Beckhoff Automation GmbH, Germany.

Contents

1.	Safety	5
1.1	Symbols Used	5
1.2	Warnings.....	5
1.3	Notes on Product Marking	5
1.3.1	Notes on CE Marking.....	5
1.3.2	UKCA Marking.....	5
1.4	Intended Use	6
1.5	Proper Environment	6
2.	Functional Principle, Technical Data	7
2.1	Measuring Principle.....	7
2.2	Structure	7
2.2.1	Sensors	8
2.2.2	Sensor Cable	9
2.2.3	Preamplifier (DL6510 only)	9
2.2.4	Preamplifier Cable (DL6510 only).....	9
2.2.5	Controller Housing.....	10
2.2.6	Oscillator	10
2.2.7	DD6500 Display Board with Ethernet Interface	11
2.2.8	Demodulator	11
2.3	Technical Data	12
3.	Delivery	13
3.1	Unpacking	13
3.2	Storage	13
4.	Installation and Assembly.....	14
4.1	Precautionary Measures.....	14
4.2	Sensor.....	14
4.2.1	Radial Point Clamping with Grub Screw, Cylindric Sensors	14
4.2.2	Circumferential Clamping, Cylindric Sensors	14
4.2.3	Flat Sensors	14
4.2.4	Dimensional Drawing Sensors	15
4.3	Sensor Cable.....	20
4.4	Preamplifier CP6001 and CPM6011.....	21
4.5	Preamplifier Cable CAx	22
4.6	Controller	22
4.7	Power Supply	23
4.8	Ground Connection, Earthing	23
4.9	Pin Assignment.....	24
4.10	Synchronization.....	25
5.	Operation	26
5.1	Initial Operation	26
5.2	Basic Settings.....	26
5.2.1	DT6530.....	26
5.2.2	DD6530	26
5.2.3	DO6510.....	27
5.2.4	DL6530/6510.....	28
5.3	Calibration with Metal Targets	30
5.4	Linearity Adjustment and Calibration with Insulator Targets.....	31
5.5	Triggering.....	33
5.6	Synchronization.....	33
6.	Ethernet Interface.....	34
6.1	Hardware, Interface	34
6.2	Data Format of Measuring Values	36
6.3	Settings.....	36
6.4	Commands	37
6.4.1	Data Rate (SRA = Set Sample Rate).....	38
6.4.2	Trigger Mode (TRG)	38
6.4.3	Get Measured Data (GMD)	39
6.4.4	Averaging Type (AVT)	39
6.4.5	Dynamic Noise Rejection.....	40
6.4.6	Averaging Number (AVN)	40
6.4.7	Channel Status (CHS).....	40
6.4.8	Channel Transmit (CHT)	40

6.4.9	Mode of Linearization (LIN).....	41
6.4.10	Set Linearization Point (SLP)	41
6.4.11	Get Linearization Point (GLP)	42
6.4.12	Status (STS)	42
6.4.13	Version (VER).....	42
6.4.14	Display Setups (DIS).....	42
6.4.15	Load Factory Setting (FDE)	43
6.4.16	SMF = Set Mathematic Function (SMF)	43
6.4.17	Get Mathematic Function (GMF)	44
6.4.18	Clear Mathematics Function (CMF).....	44
6.4.19	Ethernet Settings (IPS = IP-Settings)	44
6.4.20	Change between Ethernet and EtherCAT (IFC = Interface)	44
6.4.21	Query Data Port (GDP = Get Dataport)	45
6.4.22	Set Data Port (SDP = Set Dataport).....	45
6.4.23	Access Channel Information (CHI = Channel info)	45
6.4.24	Access Controller Information (COI = Controller info)	45
6.4.25	Login for Web Interface (Lgl = Login)	45
6.4.26	Logout for Web Interface (LGO = Logout).....	45
6.4.27	Change Password (PWD = Password).....	46
6.4.28	Change Language for the Web Interface (LNG = Language)	46
6.4.29	Write Measuring Range Information in Channel (MRA = Measuring Range)	46
6.4.30	Default Messages	46
6.5	Control via Ethernet	47
6.5.1	Requirements.....	47
6.5.2	Access via Web Interface.....	48
6.6	Firmware Update	48
7.	EtherCAT Interface	48
7.1	Introduction.....	48
7.2	Change Interface	49
8.	Operation and Maintenance	49
9.	Disclaimer	50
10.	Decommissioning, Disposal	50
A 1	Optional Accessory.....	51
A 2	Services	53
A 3	Factory Setting	53
A 4	Tilt Angle Influence on the Capacitive Sensor	53
A 4.1	Measurement on Narrow Targets.....	53
A 4.2	Measurements on Balls and Shafts	54
A 5	EtherCAT Documentation	55
A 5.1	Preamble	55
A 5.1.1	Structure of EtherCAT®-Frames	55
A 5.1.2	EtherCAT® Services.....	55
A 5.1.3	Addressing and FMMUs.....	56
A 5.1.4	Sync Manager	56
A 5.1.5	EtherCAT State Machine	57
A 5.1.6	CANopen over EtherCAT.....	57
A 5.1.7	Process Data PDO Mapping	57
A 5.1.8	Service Data SDO Service.....	58
A 5.2	CoE – Object Directory.....	58
A 5.2.1	Communication Specific Standard Objects (CiA DS-301)	58
A 5.2.2	Manufacturer Specific Objects	59
A 5.3	Measurement Data Format.....	62
A 5.4	EtherCAT Configuration with the Beckhoff TwinCAT®-Manager.....	62
A 6	Thickness Measurement.....	65
A 6.1	General	65
A 6.2	Define Sensor Measuring Ranges	65
A 6.3	Data Format, Word Length	66
A 6.4	Set Math Functions.....	66
A 6.5	Interpretation of the Measuring Values	67
A 6.6	Example.....	67

1. Safety

System operation assumes knowledge of the operating instructions.

1.1 Symbols Used

The following symbols are used in these operating instructions:



Indicates a hazardous situation which, if not avoided, may result in minor or moderate injury.



Indicates a situation that may result in property damage if not avoided.



Indicates a user action.



Indicates a tip for users.



Indicates hardware or a software button/menu.

1.2 Warnings



Disconnect the power supply before touching the sensor surface.

- > Danger of injury through static discharge

The power supply and the display/output device must be connected in accordance with the safety regulations for electrical equipment.

- > Risk of injury
- > Damage to or destruction of the sensor and/or controller



Avoid shocks and impacts the sensor and controller.

- > Damage to or destruction of the sensor and/or controller

Protect the cable against damage.

- > Failure of the measuring device

Do not plug or unplug the board (Europe size) during the operation.

- > Damage to or destruction of the board in the controller

1.3 Notes on Product Marking

1.3.1 Notes on CE Marking

The following apply to the measuring system:

- Directive 2014/30/EU (“EMC”)
- Directive 2014/35/EU (“Low Voltage”)
- Directive 2011/65/EU (“RoHS”), category 9

Products which carry the CE marking satisfy the requirements of the EU Directives cited and the relevant applicable harmonized European standards (EN). The product is designed for use in industrial and laboratory environments.

The EU Declaration of Conformity and the technical documentation are available to the responsible authorities according to the EU Directives.

1.3.2 UKCA Marking

The following applies to the product:

- SI 2016 No. 1091 (“EMC”)
- SI 2016 No. 1101 (“Low Voltage”)
- SI 2012 No. 3032 (“RoHS”)

Products which carry the UKCA marking satisfy the requirements of the directives cited and the relevant applicable harmonized standards. The product is designed for use in industrial and laboratory environments.

The UKCA Declaration of Conformity and the technical documentation are available to the responsible authorities according to the UKCA Directives.

1.4 Intended Use

The DT6530 measuring system is designed for use in industrial and laboratory areas.

It is used for

- displacement, distance, profile, thickness and surface measurement
- for in-process quality control and dimensional testing

The system must only be operated within the limits specified in the technical data, [see 2.3](#).

The system must be used in such a way that no persons are endangered or machines and other material goods are damaged in the event of malfunction or total failure of the system/sensor/controller.

Take additional precautions for safety and damage prevention in case of safety-related applications.

1.5 Proper Environment

- Protection class sensor, sensor cable, preamplifier: IP 54 (applies only for connected sensor cable)
- Protection class controller: IP 40
- The space between the sensor surface and the target must have an unvarying dielectric constant
- The space between the sensor surface and the target may not be contaminated (for example water, rubbed-off parts, dust, et cetera)
- Operating temperature
 - Sensor: -50 to +200 °C (-58 to +392 °F)
 - Sensor cable: -100 to +200 °C (-58 to +392 °F) (CCmx and CCmx/90)
-20 to +80 °C (-4 to +176 °F)
(CCgx and CCgx/90 - permanently)
-20 to +100 °C (-4 to +212 °F)
(CCgx and CCgx/90 - 10,000 h)
 - Controller, preamplifier: +10 to +60 °C (+50 to 140 °F)
- Humidity: 5 ... 95 % RH (non-condensing)
- Ambient pressure: atmospheric pressure
- Storage temperature:
 - Sensor cable: -50 ... +200 °C (-58 to +392 °F) (CCmx and CCmx/90)
-50 ... +80 °C (-58 to +176 °F) (CCgx and CCgx/90)

2. Functional Principle, Technical Data

2.1 Measuring Principle

The principle of capacitive distance measurement with the capaNCDT system is based on the principle of the parallel plate capacitor. For conductive targets, the sensor and the target opposite form the two plate electrodes. If a AC current with a constant amplitude flows through the sensor capacitor, the amplitude of the AC voltage at the sensor is proportional to the distance between the capacitor electrodes. The AC voltage is demodulated, amplified and output as an analog signal. The capaNCDT system evaluates the reactance X_c of the plate capacitor which changes strictly in proportion to the distance.

$$X_c = \frac{1}{j\omega C} ; \text{ Capacitance } C = \epsilon_0 \epsilon_r \frac{\text{area}}{d}$$

This theoretical relationship is realized almost ideally in practice by designing the sensors as guard ring capacitors.

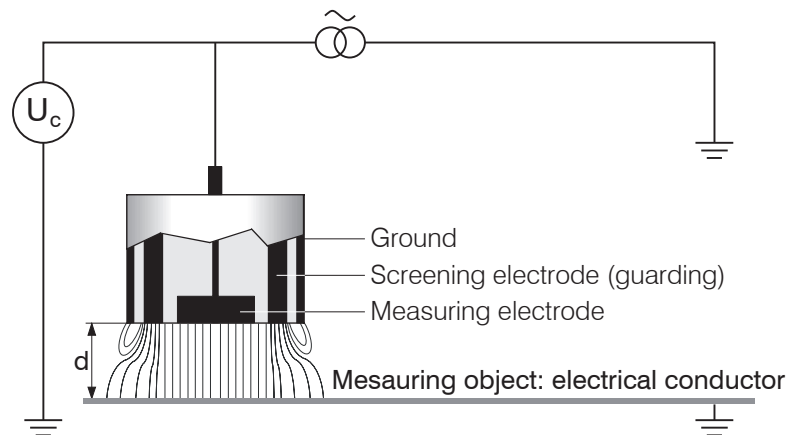

Fig. 1 Structure of a capacitive sensor

The linear characteristic of the measuring signal is achieved for electrically conductive target materials (metals) without any additional electronic linearization. Slight changes in the conductivity or magnetic properties do not affect the sensitivity or linearity.

• A small target and bent (uneven) surfaces cause a nonlinear characteristic.

The DT6530 system also measures reliably against insulating materials. The linear behavior for this category of targets is achieved by special electronic circuitry. A constant relative dielectric of the material is, however, a prerequisite for accurate measurement.

2.2 Structure

The multi-Channel non-contact, single-channel measuring system installed in an aluminum housing, consists of:

- Controller housing with power supply, display, ethernet, oscillator and analog output
- Demodulator board (Europe size) (DL6510 respectively DL 6530)
- Preamplifier CP6001 or CPM6011 (only necessary for DL6510)
- Preamplifier cable (only necessary for DL 6510)
- Sensor cable
- Sensor

Two versions of the demodulator boards are available:

- DL6530: Signal conditioning electronics with integrated preamplifier, distance sensor and controller: 1.4 m (4.6 ft) / 2 m (6 ft)
- DL6510: Signal conditioning electronics with external preamplifier, distance sensor and controller: up to 40 m

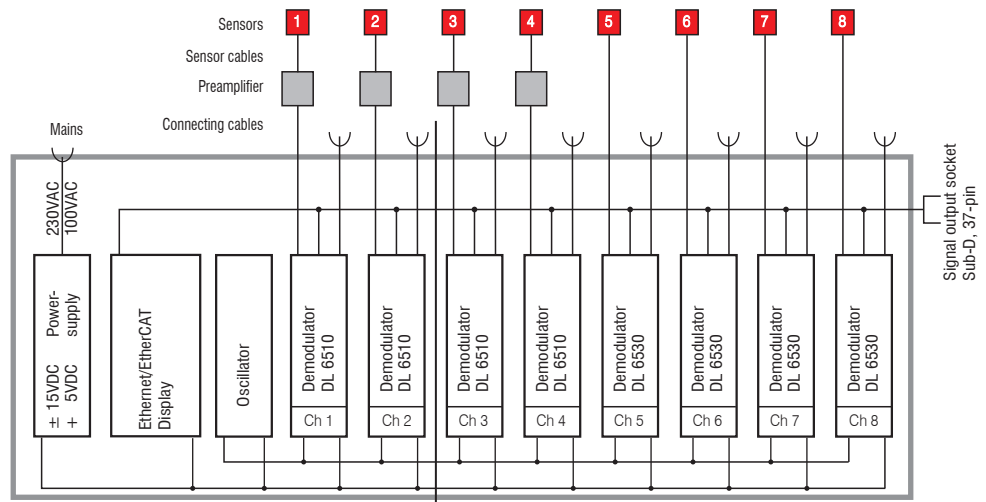

Fig. 2 Block diagram DT6530c (2 channels), block diagram DT6530 (8 channels)

2.2.1 Sensors

For this measurement system, several sensors can be used. In order to obtain accurate measuring results, the surface of the sensor must be kept clean and free from damage. The capacitive measuring process is area-related. A minimum area (see table) is required depending on the sensor model and measuring range. In the case of insulators the dielectric constant and the target thickness also play an important role.

Sensors for metal targets

Sensor model	Measuring range	Min. target diameter
CS005	0.05 mm	3 mm
CS02	0.2 mm	5 mm
CS05	0.5 mm	7 mm
CS08	0.8 mm	9 mm
CS1	1 mm	9 mm
CS1HP	1 mm	9 mm
CS2	2 mm	17 mm
CS3	3 mm	27 mm
CS5	5 mm	37 mm
CS10	10 mm	57 mm
CSE05	0.5 mm	6 mm
CSE05/M6	0.5 mm	6 mm
CSE1	1 mm	8 mm
CSE1,25/M12	1.25 mm	10 mm
CSE2	2 mm	14 mm
CSE2/M16	2 mm	14 mm
CSE3/M24	3 mm	20 mm
CSG0,50-CAm2,0	0.5 mm	ca. 7 x 8 mm
CSG1,00-CAm2,0	1 mm	ca. 8 x 9 mm
CSH02	0.2 mm	7 mm
CSH05	0.5 mm	7 mm
CSH1	1 mm	11 mm
CSH1,2	1.2 mm	11 mm
CSH2	2 mm	17 mm
CSH02FL	0.2 mm	7 mm
CSH05FL	0.5 mm	7 mm
CSH1FL	1 mm	11 mm
CSH1,2FL	1.2 mm	11 mm
CSH2FL	2 mm	17 mm
CSH3FL	3 mm	24 mm

Sensors for insulating targets

The sensors also measure reliable against insulating materials. The linear behavior for this category of targets is achieved by special linearization, see 5.4. The measuring ranges of the respective sensors depend on the ϵ_r of the target.

2.2.2 Sensor Cable

Model	Cable length	Cable \varnothing	2 axial connector	1x axial + 1x 90°	For sensors	Min. bending radius	
						once	permanently
CCgxC	2/4/6 or 8 m	3.1 mm	•		0.05 - 0.8 mm	10 mm	22 mm
CCgxC/90	2/4/6 or 8 m	3.1 mm		•	0.05 - 0.8 mm		
CCgxB	2/4/6 or 8 m	3.1 mm	•		1 ... 10 mm		
CCgxB/90	2/4/6 or 8 m	3.1 mm		•	1 ... 10 mm		
CCmxC	1.4/2.8 or 4.2 m	2.1 mm	•		0.05 - 0.8 mm	7 mm	15 mm
CCmxC/90	1.4/2.8 or 4.2 m	2.1 mm		•	0.05 - 0.8 mm		
CCmxB	1.4/2.8 or 4.2 m	2.1 mm	•		1 ... 10 mm		
CCmxB/90	1.4/2.8 or 4.2 m	2.1 mm		•	1 ... 10 mm		

NOTICE

Do not crush the sensor cable. Do not modify the sensor cable.

Both leads to a loss of functionality.

Install the sensor cable in a protected area.

The sensor and controller respectively sensor and preamplifier are connected by a special, double screened, 2 m (7.87 inches) / 1.4 m (5.5 inches) long sensor cable. Sensor cables with 8 m (31.50 inches) / 4.2 m (16.53 inches) length are with a special adjustment of the controller possible. The user must not shorten or lengthen these special cables. Usually, a damaged cable can not be repaired.

ⓘ Switch off the device when plugging and removing connectors.

2.2.3 Preamplifier (DL6510 only)

The preamplifier is necessary as connector between sensor and controller. With this preamplifier it is possible to deal with greater distances between sensor and controller. The sensor cable length is fixed at 2 m (7.87 inches) / 1.4 m (5.5 inches), (up to max. 8 m (31.50 inches) / 4.2 m (16.53 inches) with additional adjustment of the controller) and must not be modified by the user.



Fig. 3 Preamplifier CP6001



Fig. 4 Preamplifier CP6011

2.2.4 Preamplifier Cable (DL6510 only)

The drag-chain compatible preamplifier cable connects the preamplifier with the controller. It bridges distances of up to 40 m between the preamplifier and the controller.

➡ Do not shorten or lengthen these special cables.

Model	Cable Length	Min. bending radius, permanent
CA5	5 m	33 mm
CA10	10 m	
CA20	20 m	
CA25	25 m	
CA30	30 m	
CA40	40 m	

2.2.5 Controller Housing

The capaNCDT 6500 multichannel rack is constructed for up to eight channels, the capaNCDT 6500C multichannel rack is constructed for up to two channels which are all synchronized.

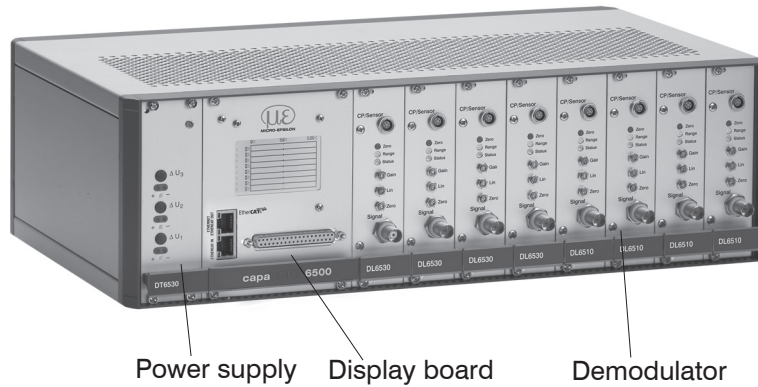

Fig. 5 Front view DT6530

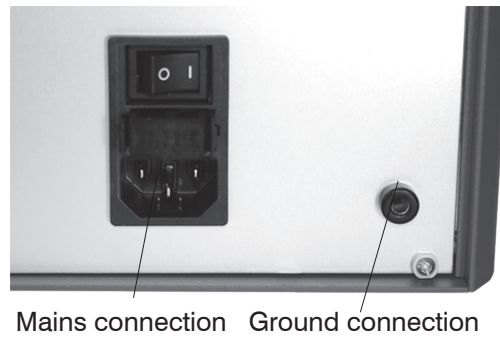

Fig. 6 Rear view DT6530



Fig. 7 Front view DT6530C

NOTICE

Output voltage can reach up 14 VDC if there is no sensor connected or target out of measuring range.

2.2.6 Oscillator

The oscillator supplies all measuring channels (sensors) with constant frequency- and amplitude- stable alternating current. The frequency is 31 kHz. As all the sensors were supplied by an oscillator, it comes not to an disturbing interference of the channels one below the other. Every second measuring channel receives an oscillator signal phase displaced by 180 °.

2.2.7 DD6500 Display Board with Ethernet Interface

The display board DD6500 serves to display and output of signal. The measuring values can be read in percent of all eight channels on display. The analog output signals (voltage and current output) the trigger input and the synchronization input/output are located on the 37-pol-Sub-D connector. The system can be connected to a network through a Ethernet interface and the measuring values can be read out digital, [see 6.](#) - Ethernet Interface. In addition, the display board contains an EtherCAT interface for transmission of the measured values in real time.

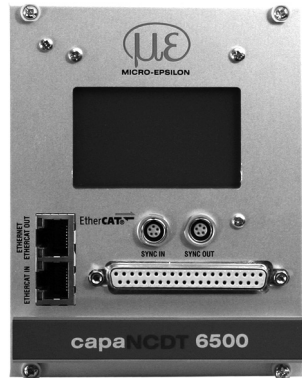

Fig. 8 Display board

2.2.8 Demodulator

Demodulation, linearization and amplifying of the distance-dependent measuring signal are tasks of the demodulation-unit. The three trim-pots allow a

- Linearity
- Gain
- Zero

adjustment of measuring system, [see 5.3](#), [see 5.4](#).



Fig. 9 Demodulator board DL 6510

2.3 Technical Data

Controller type		DT6530 DL6530 DL6510 with CP6001	DT6530 DL6510 mit CPM6011
Resolution, static	(2.6 Hz)	0.000075 % FSO	0.0006 % FSO
	(100 Hz)	0.0003 % FSO	0.0025 % FSO
	(1 kHz)	0.0009 % FSO	0.007 % FSO
	(8.5 kHz)	0.002 % FSO	0.015 % FSO
Limit frequency analog output		20 Hz; 1 kHz; 8.5 kHz (-3 dB, adjustable)	
Data rate output	Ethernet	3.9 kSa/s 7.8 kSa/s (max. 4 channels)	
	EtherCAT	2.0 kSa/s	
Linearity (typical)		±0.025 % FSO	±0.05 % FSO
Maximum sensitivity deviation		±0.05 % FSO	±0.1 % FSO
Repeatability ¹		0.0003 % FSO	0.001 % FSO
Long time stability		±0.002 % FSO / month	±0.02 % FSO / month
Synchronous operation ²		yes	yes
Insulator measurement		yes	no
Temperature stability		digital: 5 ppm/°C analog: 10 ppm/°C	80 ppm (digital and analog)
Temperature range	operation – sensor	-50 ... +200 °C (-58 ... +392 °F)	
	– controller	+10 ... +60 °C (+50 ... +140 °F)	
	storage	-10 ... +75 °C (+14 ... +167 °F)	
Power supply		100 ... 240 VAC (50 ... 60 Hz) optional: 18 ... 36 VDC	
Output	0 ... 10 V (max. 10 mA, short circuit proof); offset ≤ ±10 V up to 0 V		
	4 ... 20 mA (max. load 500 Ohm)		
	optional: 0 ... 20 mA (max. load 500 Ohm)		
	Ethernet 24 bit / EtherCAT 24 bit		
Sensors		all sensors are suitable	
Sensor cable length, standard		CCm1.4x	
		CCg2.0x	
Sensor cable length, matched		≤ 4.2 m (type CCmx)	≤ 2.8 m (type CCmx)
		≤ 8.0 m (type CCgx)	≤ 4 m (type CCgx)
Trigger		TTL, 5 V	
Humidity		5 ... 95 % (non-condensing)	
Protection class		IP 40 (controller and sensors)	

FSO = Full Scale Output

1) at constant ambient temperature (including temperature and air humidity)

2) Possible to further Controller DT6530 resp. DT6530C

3. Delivery

3.1 Unpacking

1 Housing with power supply, oscillator and display board

n Demodulators

n Sensors

n Sensor cable with connector

n Preamplifier (only DL6510)

n Preamplifier cable (only DL6510)

1 Instruction manual

37-pole Sub-D connector, mains connection cable, network cable (crossover cable)

n = Number of displacement measuring channels

➡ Remove the parts of the system carefully from the packaging and transport them in such a way that they are not damaged.

➡ Check for completeness and shipping damages immediately after unpacking.

In case of damage or missing parts, please contact the manufacturer or supplier.

3.2 Storage

Temperature range storage: -10 ° ... +75 °C (+14 ... 167 °F)

Humidity: 5 ... 95 % RH (non-condensing)

4. Installation and Assembly

4.1 Precautionary Measures

No sharp-edged or heavy objects may get into contact with the sensor cable sheath. Protect the cable in pressurized rooms against pressure loads.

Avoid kinks in any case. Check the connections for tight fit.

- A damaged cable cannot be repaired.

4.2 Sensor

The sensors may be mounted free-standing or flush.

➡ When assembling, make sure that the polished sensor surface is not scratched.

4.2.1 Radial Point Clamping with Grub Screw, Cylindric Sensors

This simple type of fixture is only recommended for a force and vibration-free installation position. The grub screw must be made of plastic so that it cannot damage or deform the sensor housing.

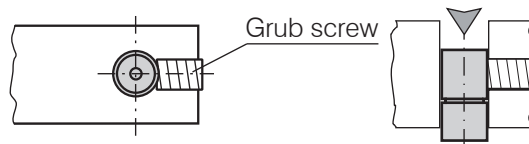

Fig. 10 Radial point clamping with grub screw.

- Do not use metal grub screws
- ! > Danger of damaging the sensor

4.2.2 Circumferential Clamping, Cylindric Sensors

This sensor mounting option offers maximum reliability because the sensor is clamped around its cylindrical housing. It is absolutely necessary in difficult installation environments, for example on machines, production plants et cetera.

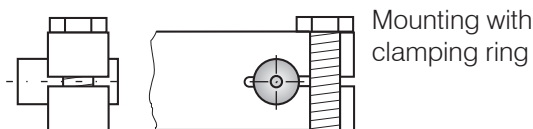
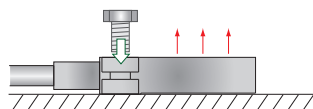

Fig. 11 Circumferential clamping

4.2.3 Flat Sensors

Flat sensors are mounted by means of a tap hole for M2 (in case of sensors 0.2 and 0.5 mm) or by a through hole for M2 screws. The sensors can be bolted on top or below.

Screwing from above



Screwing from bottom

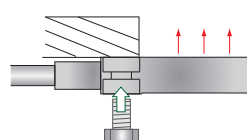

4.2.4 Dimensional Drawing Sensors

Cylindric sensors

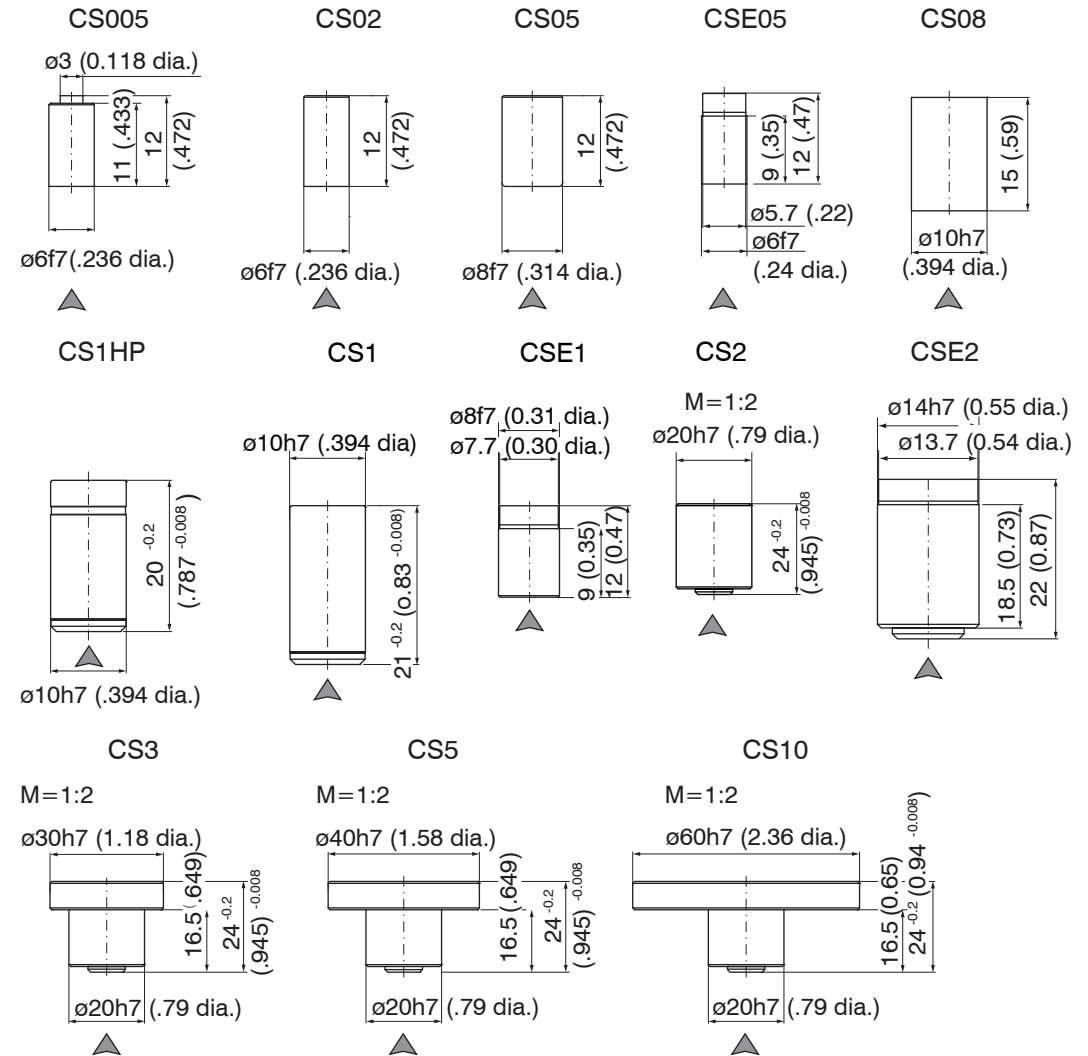

▲ Connector side

Dimensions in mm (inches)

x = cable length in m

Circumferential clamping possible beginning 3 mm behind the sensor surface.

Drawings of other sensors are available upon request.

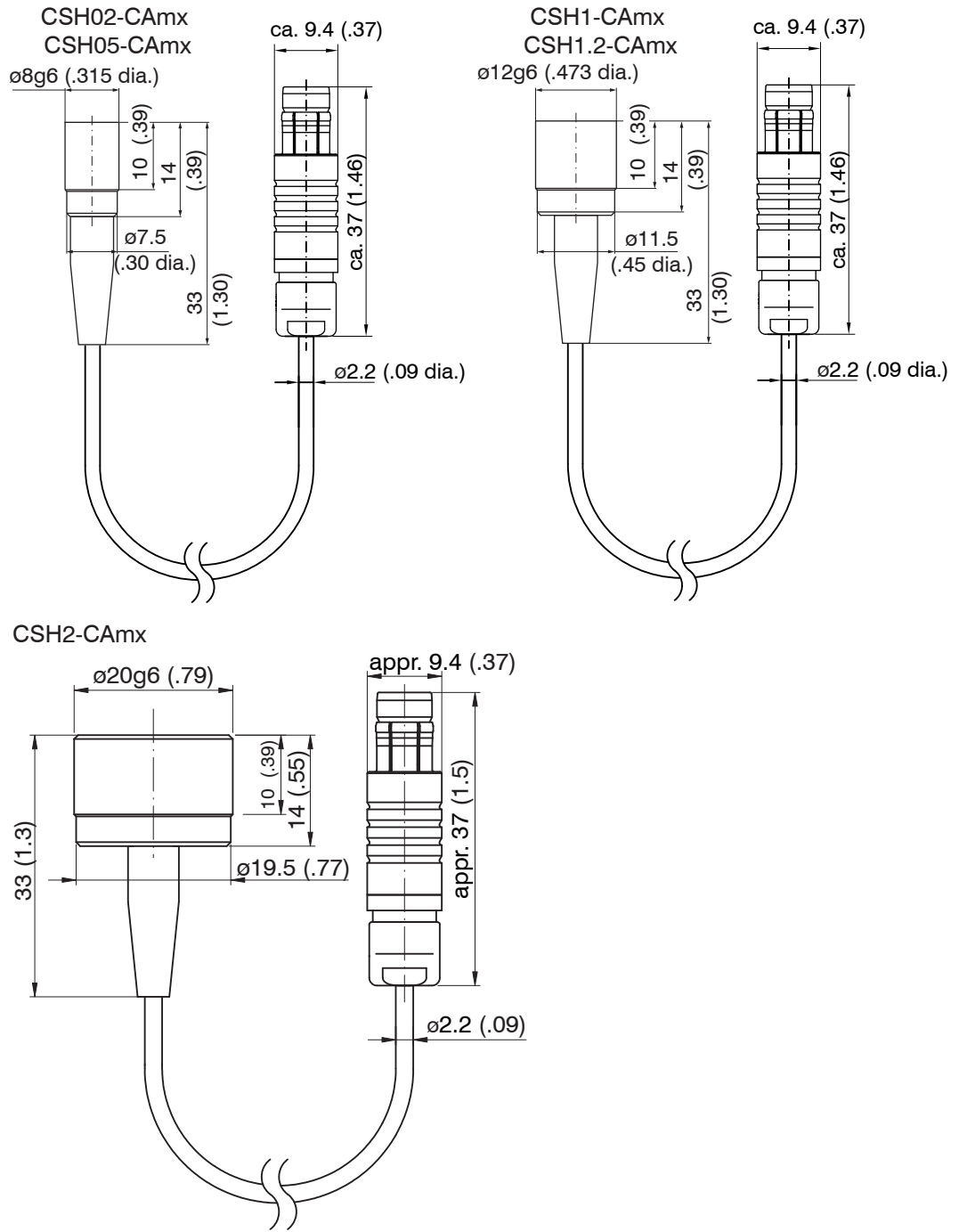

Cylindrical sensors with integrated cable

▲ Connector side

Dimensions in mm (inches)

Circumferential clamping possible beginning 3 mm behind the sensor surface.

Drawings of other sensors are available upon request.

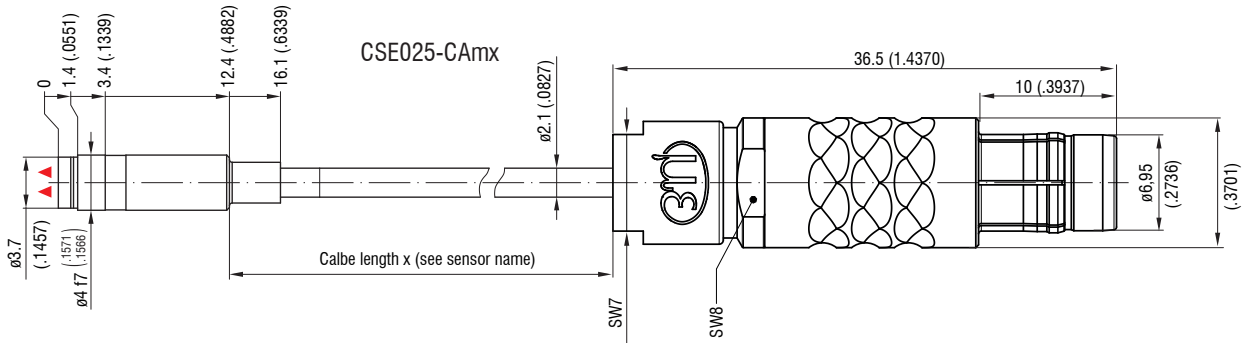
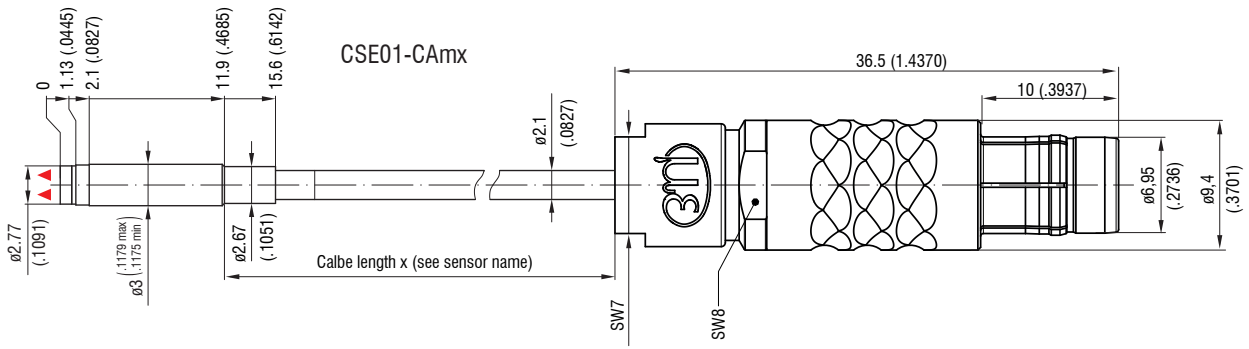

▲ Connector side

Dimensions in mm (inches)

x = cable length in m

Circumferential clamping on the fit f7 as far forward as possible (from 2.1 mm or 1.4 mm)

Drawings of other sensors are available upon request.

▲▲ Active measuring surface sensor

Cylindrical sensors with thread

CSE05/M8

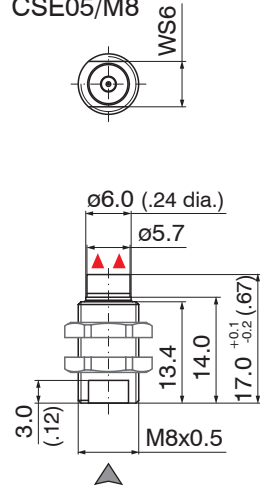

CSE1,25/M12

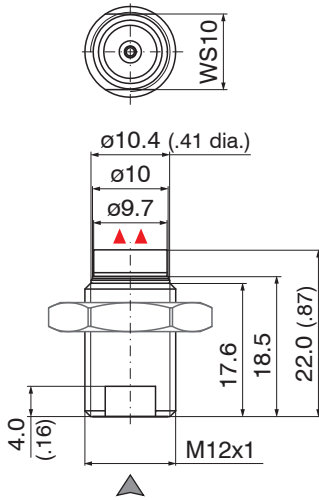

CSE2/M16

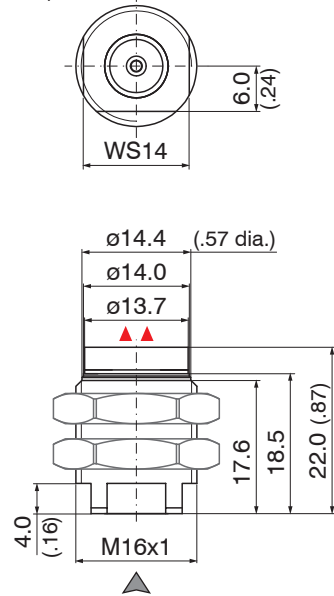

CSE3/M24

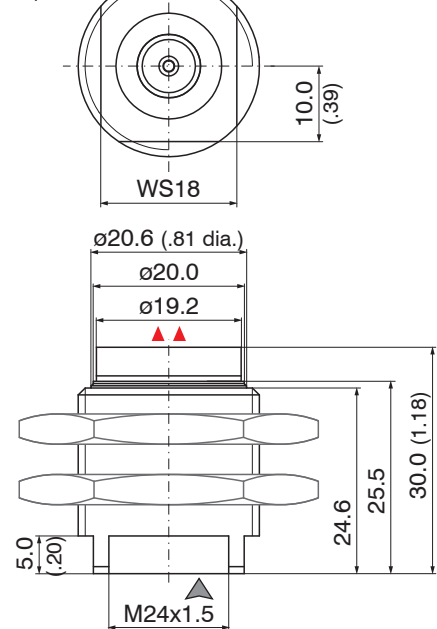

▲ Connector side

Dimensions in mm (inches)

▲▲ Active measuring surface sensor

Sensor	Torque
CSE05/M8	2.5 Nm max.
CSE1,5/M12	10 Nm max.
CSE2/M16	20 Nm max.
CSE3/M24	70 Nm max.

Drawings of other sensors are available upon request.

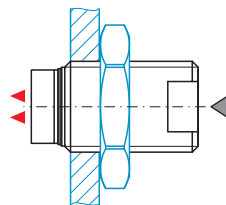

Preferred mounting:

- Screw the sensor into the sensor holder.
- Turn the mounting nut on. Do not exceed torques.

Flat sensors

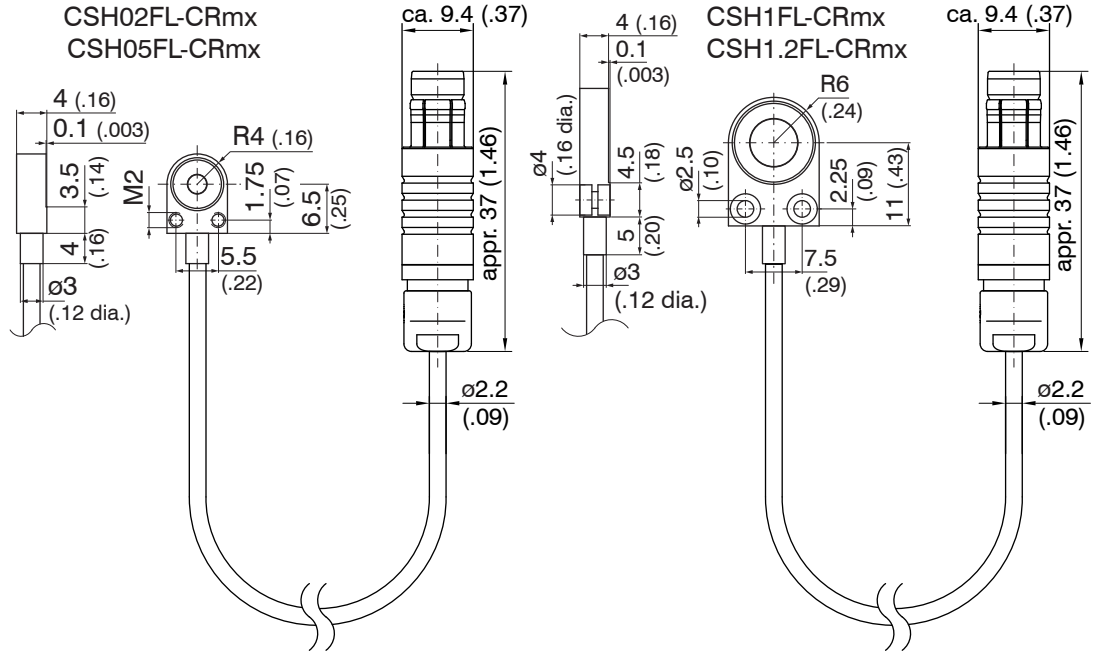

CSH2FL-CRmx

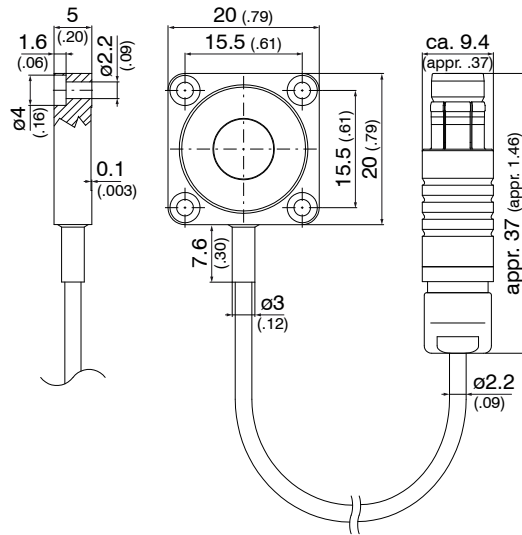

CSH3FL-CRmx

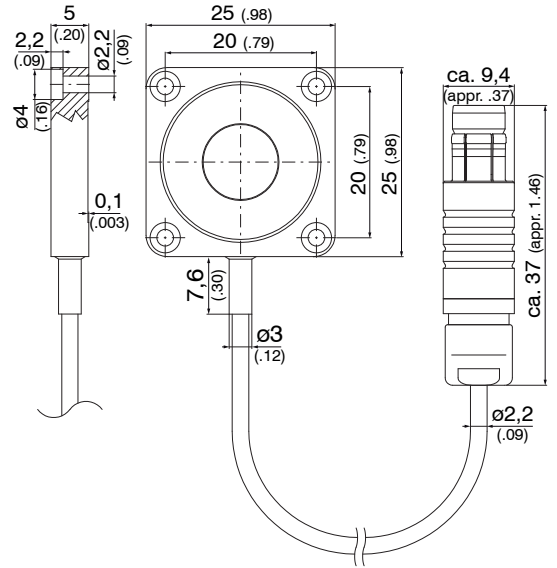

CSG0.50-CAm2.0 and CSG1.00-CAm2.0

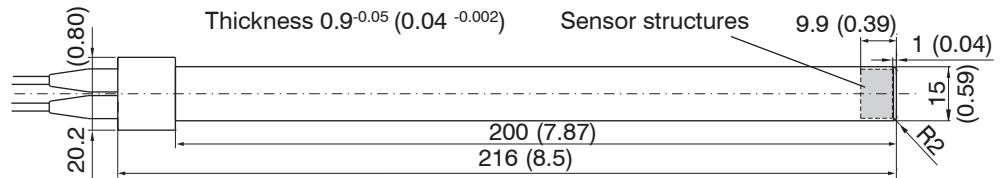

Sensor structures

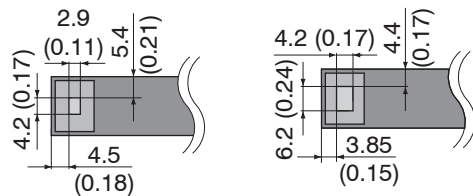

4.3 Sensor Cable

The sensor is connected to the signal conditioning electronics by the sensor cable. The connection is made by simple plugging. The connector locks automatically. The tight fit can be checked by pulling the connector housing (cable bushing). The lock can be released and the connector can be opened by pulling the knurled housing sleeve of the cable bushing.

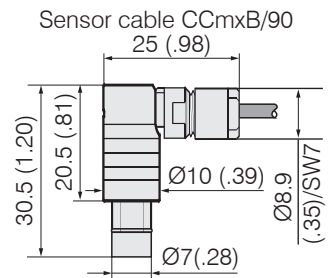
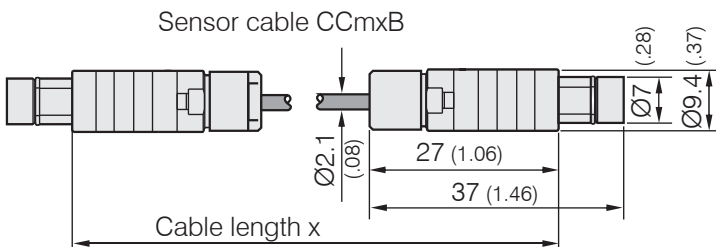
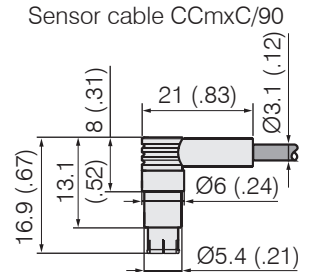
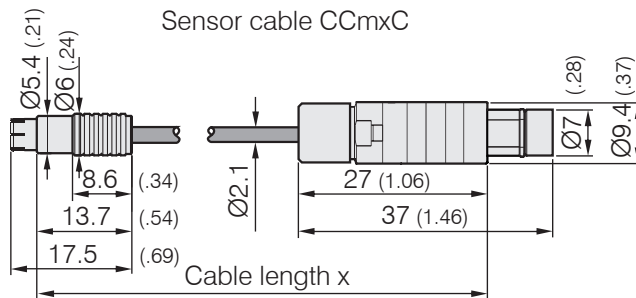
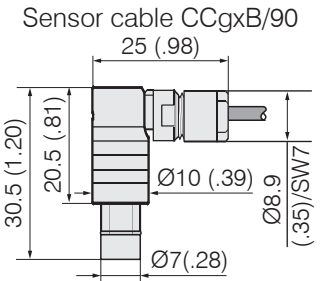
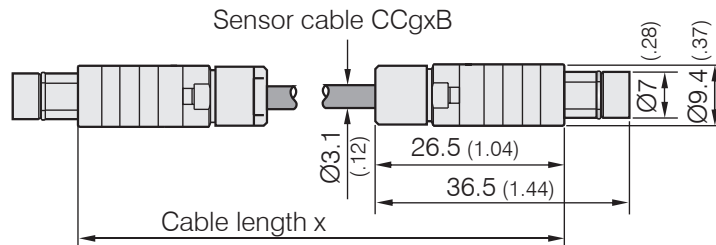
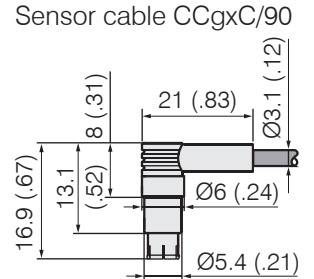
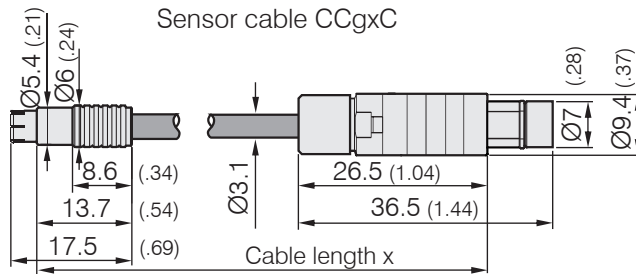

Model	Cable length	Cable \varnothing	2 axial connector	1x axial + 1x 90°	For sensors	Min. bending radius	
						once	permanently
CCgxC	2/4/6 or 8 m	3.1 mm	•		0.05 - 0.8 mm	10 mm	22 mm
CCgxC/90	2/4/6 or 8 m	3.1 mm		•	0.05 - 0.8 mm		
CCgxB	2/4/6 or 8 m	3.1 mm	•		1 ... 10 mm		
CCgxB/90	2/4/6 or 8 m	3.1 mm		•	1 ... 10 mm		

CCmxC	1.4/2.8 or 4.2 m	2.1 mm	•		0.05 - 0.8 mm	7 mm	15 mm
CCmxC/90	1.4/2.8 or 4.2 m	2.1 mm		•	0.05 - 0.8 mm		
CCmxB	1.4/2.8 or 4.2 m	2.1 mm	•		1 ... 10 mm		
CCmxB/90	1.4/2.8 or 4.2 m	2.1 mm		•	1 ... 10 mm		

4.4 Preamplifier CP6001 and CPM6011

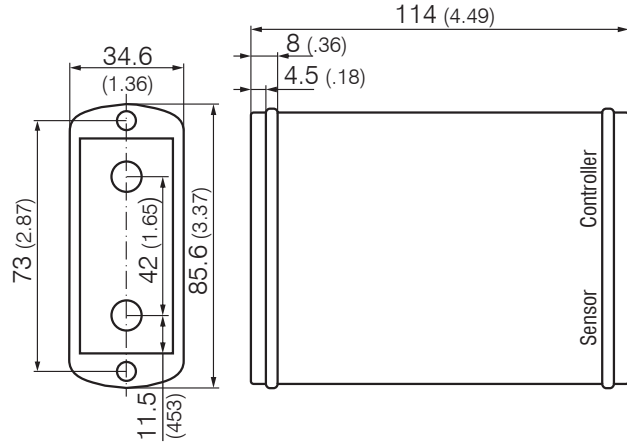

Fig. 12 Preamplifier CP6001

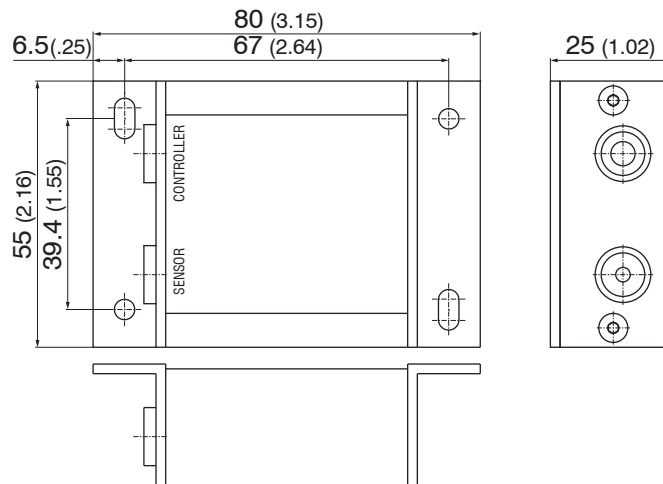

Fig. 13 Preamplifier CPM6011

Mounting preamplifier with mounting device (CP6001)

- ➡ Remove the four black protecting caps at the housing screws, dimension 73.
- ➡ Remove the four housing screws.
- ➡ Fix the both mounting devices at the preamplifier. Use the screws contained in the delivery.

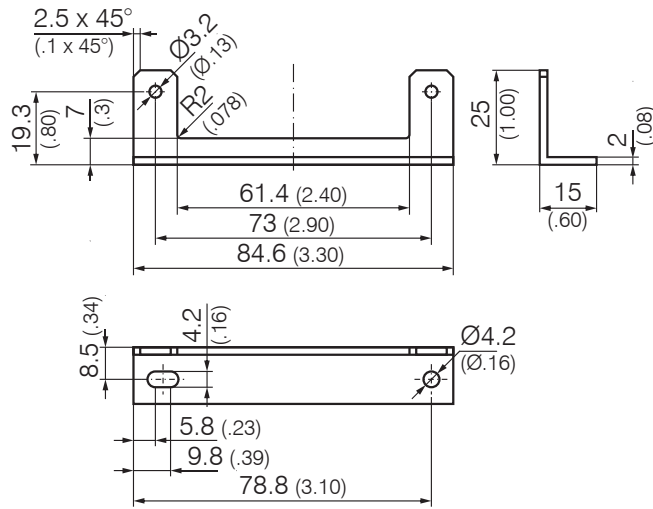
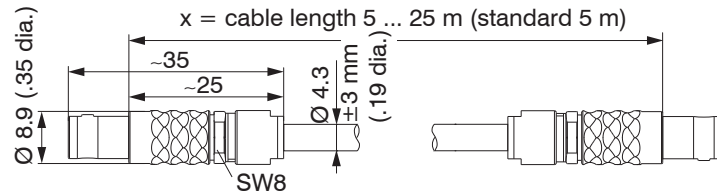

Fig. 14 Mounting device for preamplifier

Dimensions in mm (inches), not to scale.

4.5 Preamplifier Cable Cax



4.6 Controller

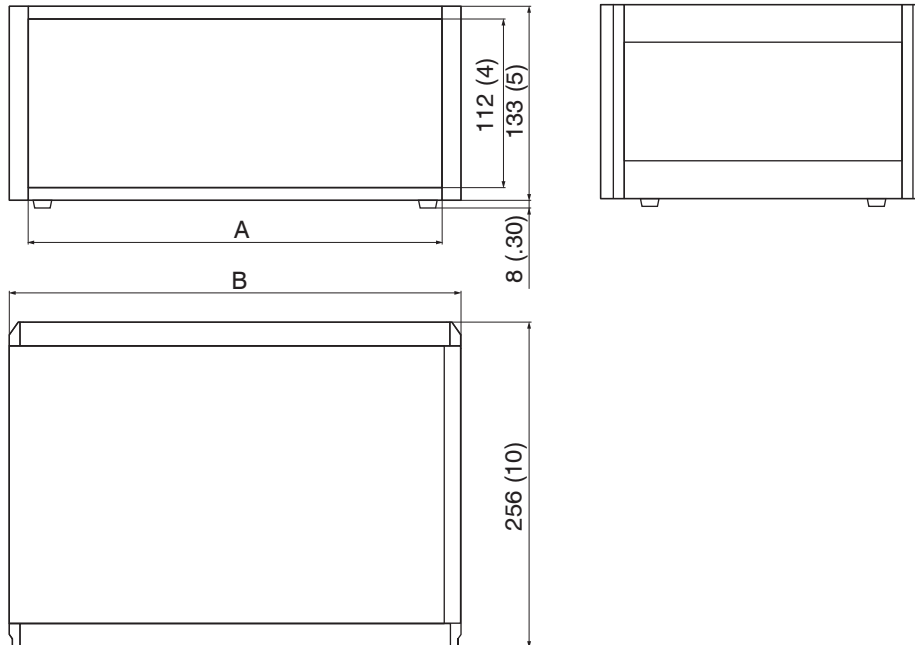

Model	A	B
6530c (maximum 2 channels)	214 (8)	236 (9)
6530 (maximum 8 channels)	427 (17)	449 (18)

Dimensions in mm (inches), not to scale

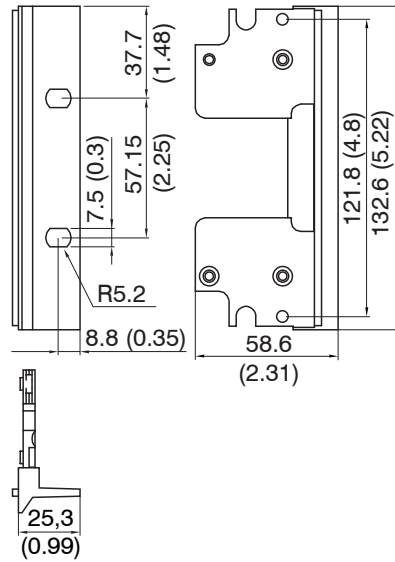

Fig. 15 Clamping angle

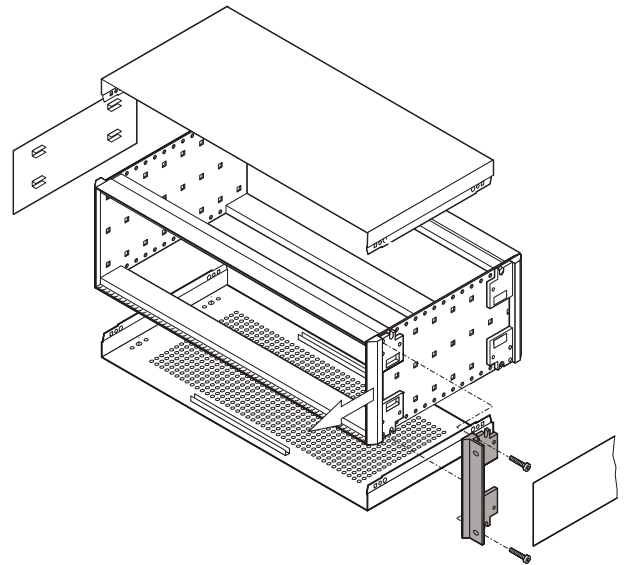

Fig. 16 Mounting of clamping angle

4.7 Power Supply



Fig. 17 Rear view with kettle plug, fuse; 230 VAC

4.8 Ground Connection, Earthing

The sensor housings are connected to signal ground and supply ground.

Non-contact target earthing

In several applications, the target earthing is difficult or even impossible. Different to other systems, with capaNCDT systems is no target earthing necessary.

Fig. 14 shows two synchronized capaNCDT sensors, measuring against a mill. Due to the unique synchronizing technique of Micro-Epsilon is in most cases a special target earthing not needed.

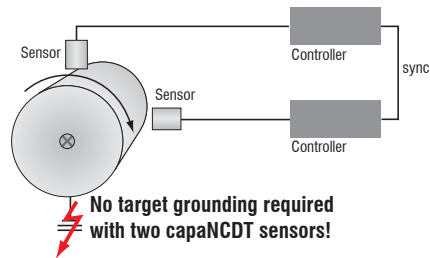

Fig. 18 Position- and unbalance measuring with two systems

➡ Connect the target with the ground connection on the rear side of the controller electrically-conductive, see Fig. 6.

4.9 Pin Assignment

This module is used for signal display and output when measuring, calibrating or checking the system. The output voltage can be tapped at the BNC connectors of the demodulator boards additionally.

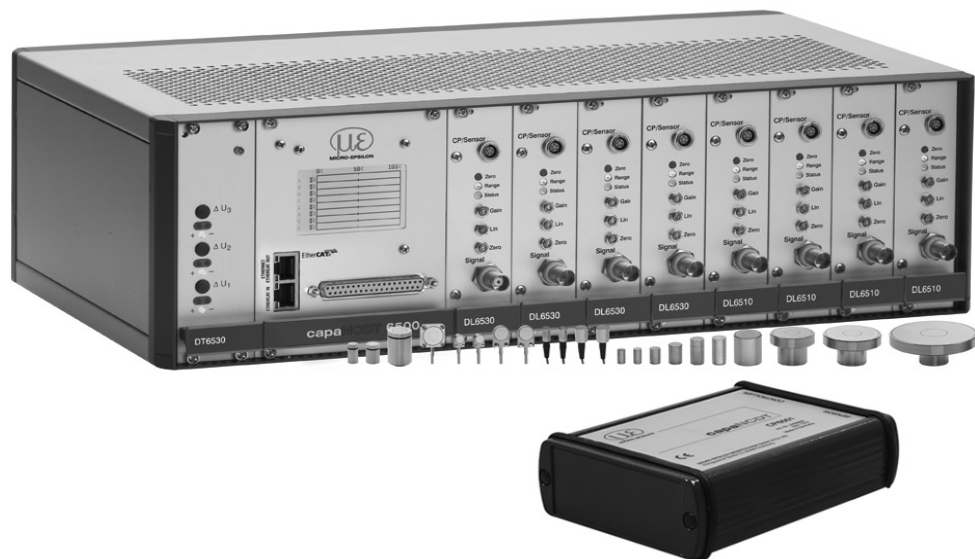

Fig. 19 Measuring unit with controller, preamplifier, and sensors

37-pole Sub-D connector:

1	U-Out Channel 1	13	Trigger_In	25	AGND Channel 6
2	U-Out Channel 2	14	Sync_In-8M	26	AGND Channel 7
3	U-Out Channel 3	15	Sync_Out-8m	27	AGND Channel 8
4	U-Out Channel 4	16	Sync_In-31K	28	I-Out Channel 2
5	U-Out Channel 5	17	Sync_Out-31K	29	I-Out Channel 4
6	U-Out Channel 6	18	N.C.	30	I-Out Channel 6
7	U-Out Channel 7	19	N.C.	31	I-Out Channel 8
8	U-Out Channel 8	20	AGND Channel 1	32	GND_Trigger_I
9	I-Out Channel 1	21	AGND Channel 2	33	Sync_In+ 8M
10	I-Out Channel 3	22	AGND Channel 3	34	Sync_Out+ 8M

11	I-Out Channel 5	23	AGND Channel 4	35	Sync_In+ 31K
12	I-Out Channel 7	24	AGND Channel 5	36	Sync_Out+ 31K
				37	n. c.

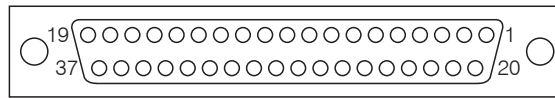

Fig. 20 View: Solder pin side, 37-pole male cable connector

In addition the following should be noted when assembling the user-side power supply and trigger cable.

- Use a screened cable.
- Connect the screening mesh with the connector housing.
- Use a separate screened cable for the trigger signal.

Maximum cable length amounts to 3 m.

Recommended conductor cross-section 0.14 mm².

The EMC regulations, see 1.3.1, are only satisfied if these basic conditions have been observed.

4.10 Synchronization

Several measuring systems capaNCDT 6500 can simultaneously be used as multi-channel system. With the synchronization of the systems, a mutual influence to the sensors is avoided

- Plug the synchronize cable SC6000-x (accessory) into the female connector SYNC OUT (synchronization output) at the controller 1.
- Plug the second end of SC6000-x into the female connector SYNC IN at the controller 2.

The oscillator of controller 2 switches automatically into synchronization, this means, depending on the oscillator of controller 1.

An influence of poor earthed target is excepted.

Where necessary, synchronize more measuring systems with the cable SC6000-x.

i Automatic synchronization. Every controller can be master.

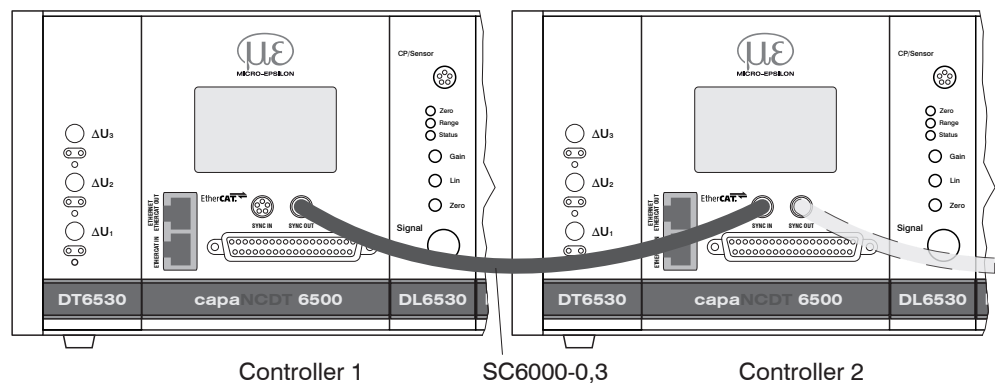

Fig. 21 Synchronization of a second controller

NOTICE

Do not plug-in or unplug any board during the operation!
This leads to defaults of the controller!

5. Operation

5.1 Initial Operation

Pay attention to switching on the device, that you have plugged-in all boards in the designated positions.

Let warm up the measuring system for about 15 minutes before you run a measuring or calibration. This avoids measuring inaccuracies.

5.2 Basic Settings

5.2.1 DT6530

After switching-on the power supply the three LED's show the existence of the internal supply voltages. The controller is ready for use, if all three LED's flash.

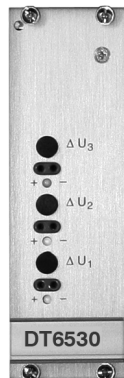

Fig. 22 LED's for power supply

5.2.2 DD6530

The digital measuring values of all channels were shown on the display board DD6500. The measuring values are scaled from 0 to 100 %. The display does not show the full resolution of the measurement channel. Its 1/10000 display resolution for each channel for monitoring purpose. For the maximum resolution of the displacement signal please use the dialog or digital interface. The display settings, see 6.4.14, enable

- a change between linearized or non-linearized values.
- a selection of channels for upgrading.

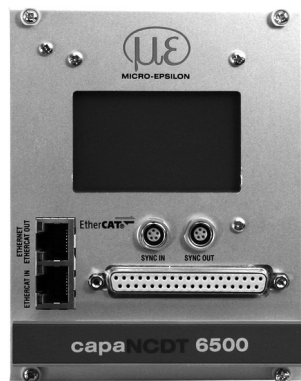

Fig. 23 Display and interface board

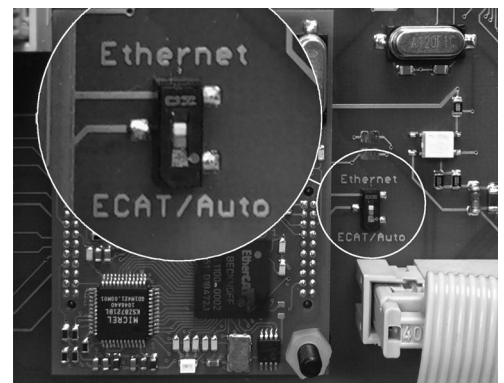

Fig. 24 Change Ethernet/EtherCAT

A switch between Ethernet and EtherCAT, is possible via a hardware switch (image) or via software.

If the switch is in position Ethernet, always the Ethernet interface is active independent of the software setting. If the switch is in position ECAT/Auto, then the active interface depends on the software setting. To change the interface it is necessary to restart the controller.

5.2.3 DO6510

The optional analog output card DO6510 outputs digitally computed measurement signals in analog form. The DO6510 includes 3 analog outputs which can output signals either in the range 0 ... 10 V, ± 5 V, or in the range 4 ... 20 mA. A rotary switch to the side of the slot is used to select the type of output. The analog outputs have a theoretical resolution of 16 bit and they are updated with the data rate specified in the DT6500.

The DO6510 outputs the computed mathematical functions in ascending order – using the channels containing these functions – to connectors Analog Out1 ... 3.

Example:

You define two mathematical functions, one on channel 4 and one on channel 6. The results of these functions are then output to Analog Out1 (mathematical function of channel 4) and Analog Out2 (mathematical function of channel 6). If you delete the math function for channel 4, the math function of channel 6 is going to be output to Analog Out1 from now on.

Restricting the output area: The output range is scaled to match the largest range which is used in a mathematical function.

Example:

Math function for channel 1: measuring range 2000 μm .

Match function for channel 2: measuring range 500 μm .

The analog output is scaled to 2000 μm , which is equivalent to 100 %.

If you want to add the two channels together, you will need to scale the channels (e.g. math function = 0.5 x channel 1 + 0.5 x channel 2) in order to prevent an overflow.

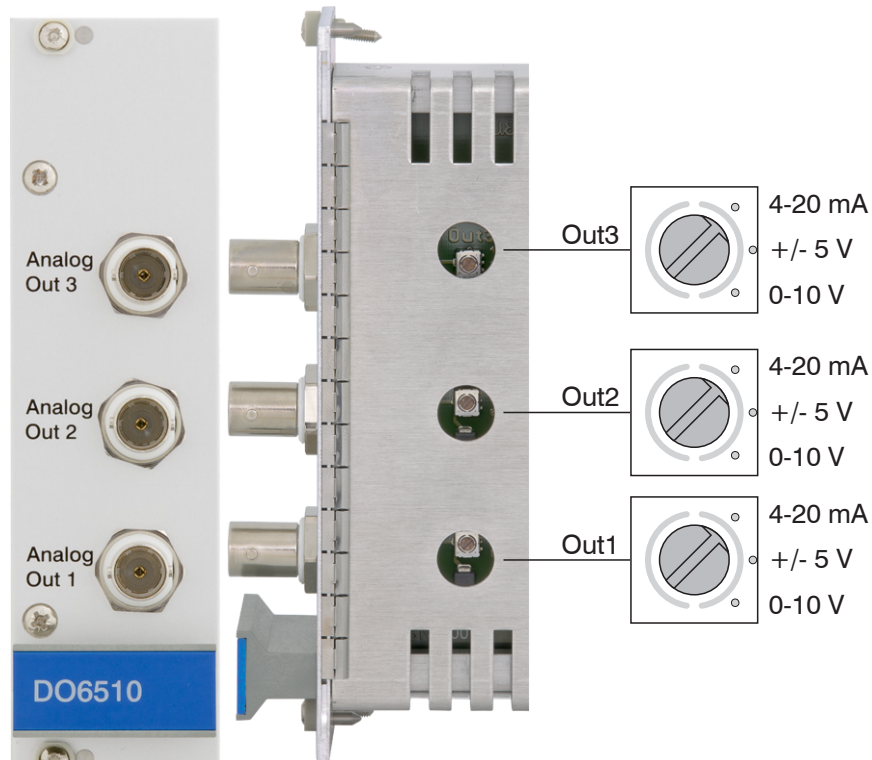

Fig. 25 DO6510 with analog output connectors and rotary switch for voltage and current selection

5.2.4 DL6530/6510

Gain, zero and linearity of a measuring channel are adjusted with the “Gain“, “Zero“ and “Lin“ trimmer potentiometers, see Fig. 26. The setting range is approximately 18 turns per potentiometer. The end settings at the left and right stops are recognizable by a slight click.

- The “Zero“ trimmer potentiometers affects the analog output.
- The “Gain“ and “Lin“ trimmer potentiometers affect the analog and digital output.
- The potentiometers “Lin“ and “Gain“ are only active at non-conducting targets.

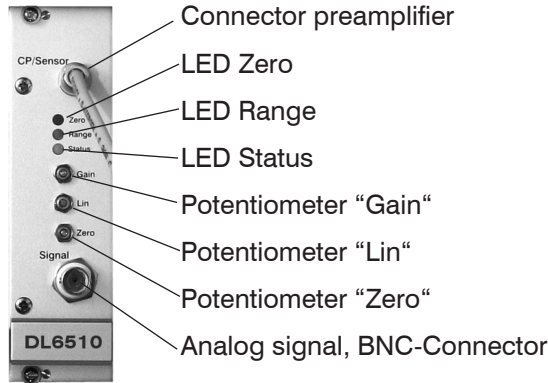
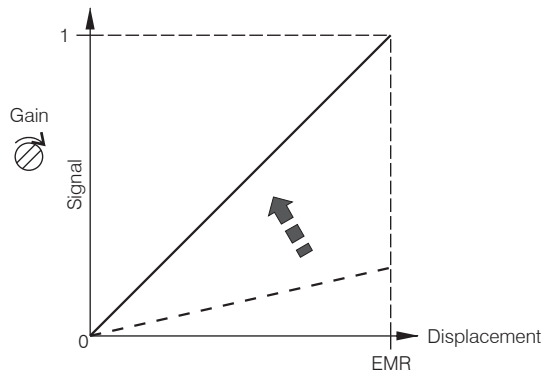

Fig. 26 Front view DL6510

LED		Color	Function
ZERO	○		Factory setting
	☀	red	Controller operates with changed factory settings
RANGE	☀	green	Target in measuring range
	☀	red	Target out of measuring range
STATUS	○		Controller failure
	☀	orange	Controller OK

The potentiometer are ex factory set at the right stop (maximum level).

Trimmer Gain: Turn the trim-pot clockwise to increase the slope of the characteristic line.



Trimmer Lin: Turn the trim-pot clockwise to increase the quadratic component.

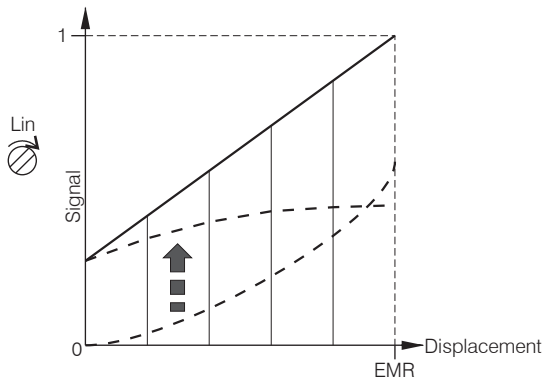

Trimmer Zero: Turn the trim-pot clockwise to shift the characteristic line to the left.

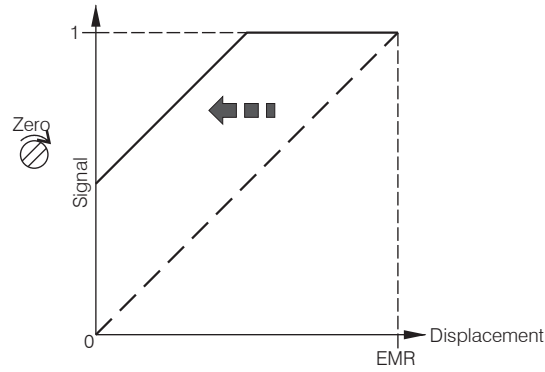

EMR = End of measuring range

i The Zero-Poti affects only the analog outputs, not yet the digital measuring values.

Target selection

Use the slide switch, see Fig. 27, to switch between conducting (Cond.) and non-conducting targets (Insul.). In position Cond. (conductor) only the zero setting with the zero-trimmer is active. The amplifying is set to 0 up to 10 V at the entire measuring range.

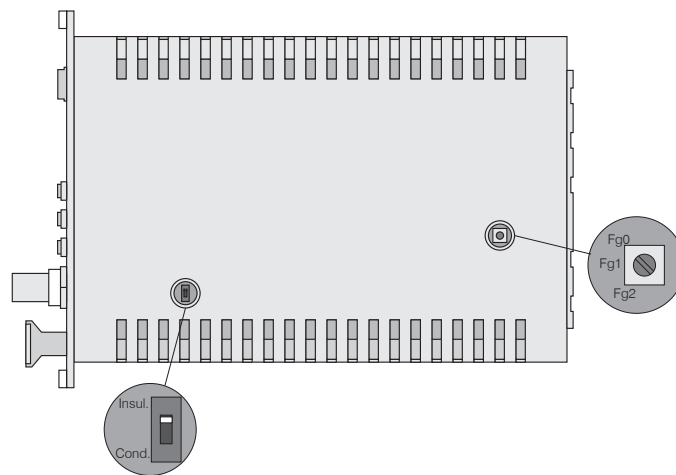

Fig. 27 Switches on board for material selection and limit frequency

Limit frequency analog output

The limit frequency of the analog output signal can be set with a rotary switch on the board, see Fig. 27.

Three positions are possible:

Limit frequency fg0 = 8.5 kHz

Limit frequency fg1 = 1 kHz

Limit frequency fg2 = 20 Hz

5.3 Calibration with Metal Targets

Preconditions:

- Specific resistance of the target < 100 Ωcm.
- Slide switch on the demodulator in position *Cond.* (Conductor, see Fig. 27)

For metallic targets the demodulator’s linearization function is switched off since a linear characteristic is already available automatically on account of the measuring principle and sensor construction.

The measuring device is set to a sensitivity of 10 Volts corresponding to the measuring range of each sensor model.

The electrical zero point can be set across the whole measuring range with the “zero” potentiometer of the demodulator module. The start of the measuring range (= mechanical zero point) is on the front face of the sensor.

A tilted sensor or measuring object results in a reduced measuring range and zero point shifting according to the tilting.

Curved target surfaces cause linearity reductions if the distance between the sensor and the target is small.

Also with small target surfaces losses in linearity and sensibility occur.

Extension of the measuring range:

The sensor measuring ranges can be extended considerably (by a factor of 2-3) with some loss in linearity and sensitivity.

➡ To do this, move the slide switch on the demodulator board to position *Insul.* (insulating materials, see Fig. 27). Make the necessary linearity adjustment as described, see 5.4.

In step 1 here the following potentiometer setting is assumed:

- Potentiometer “Zero“ (Zero-point): right stop
- Potentiometer “Lin“ (Linearity): right stop
- Potentiometer “Gain“ (Amplification) left stop

➡ Carry out the complete calibration up to step 4.

• Ex factory doubling of measuring range possible by internal matching.

5.4 Linearity Adjustment and Calibration with Insulator Targets

Preconditions:

- Specific resistance of the target > $10^6 \Omega\text{cm}$.
- Slide switch on the demodulator in position *Insul.* (Insulation, see Fig. 27)

The measuring channel must be individually linearized and calibrated prior to measurements against insulator targets. Adjustment takes place at defined distances which are prescribed by a reference. A special micrometer calibration device with a non-rotating micrometer spindle (for example MC25 from MICRO-EPSILON) has proved to be particularly suitable. Spacer discs are not suitable.

The following parameters influence the calibration. Later operating conditions should be simulated as accurately as possible for the calibration. If one of these parameter changes, recalibration is recommended.:

- Resistivity of the target
- Dielectric constant of the target
- Shape and thickness of the insulator
- With thin targets, metal behind the target may influence the propagation of the field lines.

The bigger the relative dielectric constant of a measuring target is, the higher is the sensitivity of the measuring system.

Step 1:

Settings:

- Potentiometer “Zero“ (Zero-point) right stop
- Potentiometer “Gain“ (Amplification) middle
- Potentiometer “Linearity“ (Linearity) middle

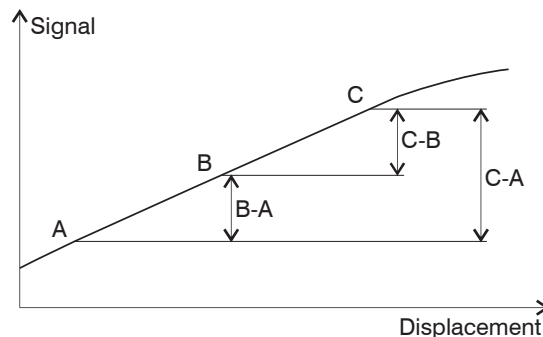

Fig. 28 Define the active measuring range

- ➡ Record the measuring curve of the sensor (at least 10 points). Choose a range of low and as constant as possible curvature from this curve and determine the points:
 - A Start of measuring range
 - B Centre of measuring range
 - C End of measuring range

The output signal should not exceed 10 V in the chosen measuring range. If necessary, the sensitivity can be reduced with the “Gain“ potentiometer.

Step 2: Linearity

The measured value differences B-A and C-B are calculated from the fixed measuring points A B C and compared with each other. The setting of the linearity potentiometer is now altered until B-A and C-B are identical.

If the setting is not valid, you can do the following:

- ➡ Add with the trimmer “Lin“ a quadratic component to the signal, which compensates the physical not linear characteristic of insulators.
- ➡ If the value C exceeds 10 V the sensitivity (“Gain“) must be reduced.

If the “Lin“ potentiometer is at the stop and B-A and C-B are still not equal, points A and C have probably been badly chosen. Start again with step 1.

Step 3: Sensitivity

In order to set a practicable sensitivity, first form the signal difference C-A and select a sensitivity which matches the measuring range (for example 1 V/mm). Set the distance point C and calculate the required measured value C'.

$$C' = C \frac{E}{(C - A)}$$

E ... desired signal span point A to C

C ... signal value at distance point C

A ... signal value at distance point A

If C' is not more than 10 V, set it with the “gain“ potentiometer.

As a final check, run through the whole measuring curve and document it.

Step 4: Zero point

Finally the electrical zero point can now be shifted with the trim-pot “Zero“ without affecting the linearity and sensitivity.

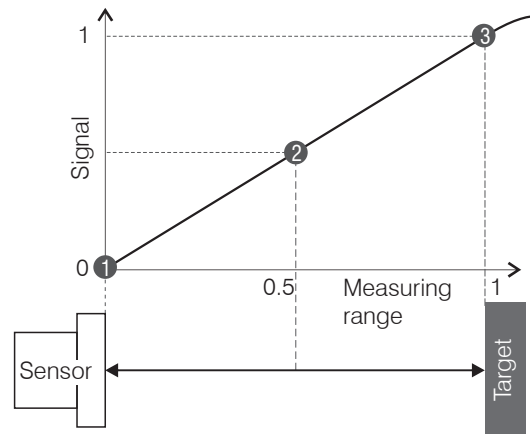

Fig. 29 Signal behavior of the output voltage

Advice for digital interface

Zero point shifting, option of digital linearization, possible by software. Please take details, see 6.

If the measuring values were selected digitally, the analog and digital measuring values disagree after a zero point shifting with the zero-poti.

5.5 Triggering

The DT6530 can be operated

- by a trigger input, [see Fig. 30](#), or
- via a software command, [see 6.4.3](#).

In addition the trigger mode must be activated and a data rate, which is greater than the maximum trigger frequency, must be set.

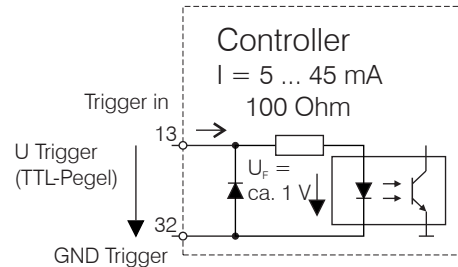

Fig. 30 Trigger input

There are three possible settings regarding the trigger input:

- Trigger mode 1 (rising edge): At each rising flank per channel one measured value is sent. The data rate set has to be higher than the maximum trigger frequency. If triggering is effected faster than the set data rate, some measured values are sent twice due to the fact that no further measured values have been generated by the analogue digital converter yet.
- Trigger mode 2 (high level): As long as a logical high level is connected to the trigger input, measured values are sent thanks to the data rate set.
- Trigger mode 3 (gate rising edge): At the first rising flank on the trigger input, the controller starts to send measured values by means of the data rate set. At the second rising flank the controller stops to send measured values et cetera.

Irrespective of the trigger mode set, one single measured value per channel can be called up by means of a software command, [see 6.4.3](#).

5.6 Synchronization

Up to 8 controllers can be synchronized via the 37-pin Sub-D female connector.

To do this, connect all SYNC_OUT outputs to the corresponding Sync_in inputs of the subsequent controller. Use twisted pair for the matching signals.

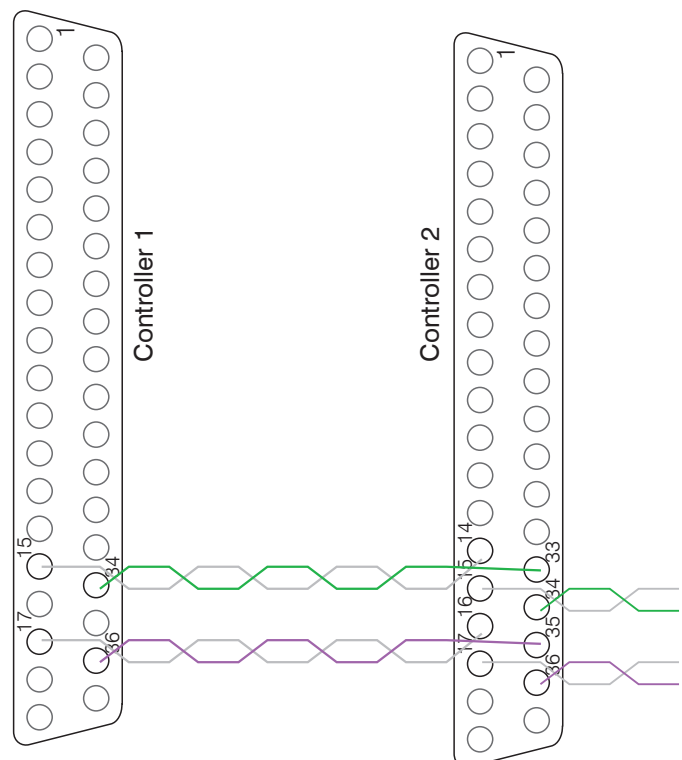

Fig. 31 Synchronization wiring for two controllers

6. Ethernet Interface

You will achieve especially high resolutions if you readout the measurements in digital form via the Ethernet interface.

For that purpose, use the web interface, the runtime version or your own program. Micro-Epsilon supports you by the driver MEDAQLib, containing all commands for the capaNCDT 6500.

You can find the current driver routine including documents at:

www.micro-epsilon.com/download

www.micro-epsilon.com/download/software/MEDAQLib.zip

6.1 Hardware, Interface

In order to use the Ethernet interface, a demodulator module must be provided in channel 1 as this one determines the cycle for all channels!

The data logging of all channels is synchronous.

➡ Connect the DT6530 to an available Ethernet interface at the PC. Use a crossover cable.

For a connection with the DT6530 you will require a defined IP address of the network interface card inside the PC. Go to Control Panel\Network. Set up, if applicable, a new LAN connection. For more information, contact your network administrator.

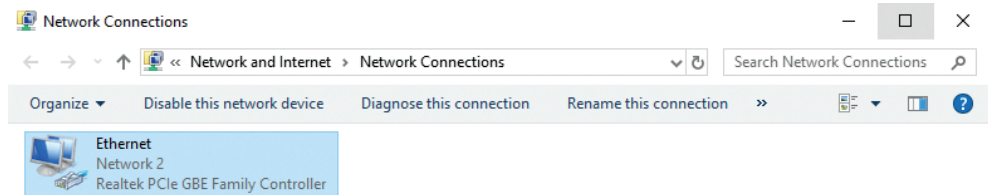
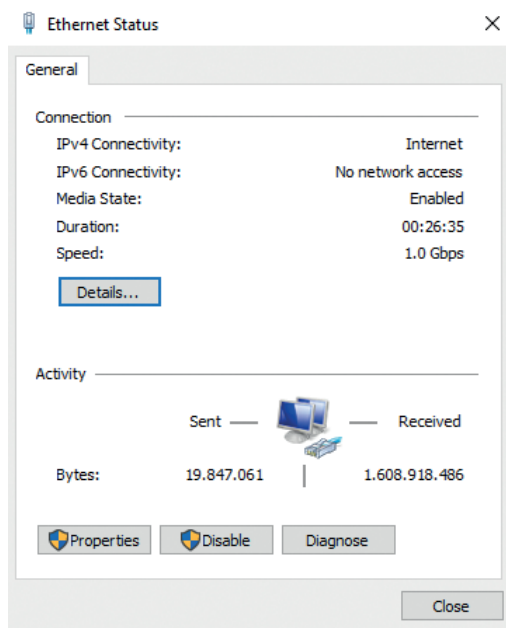
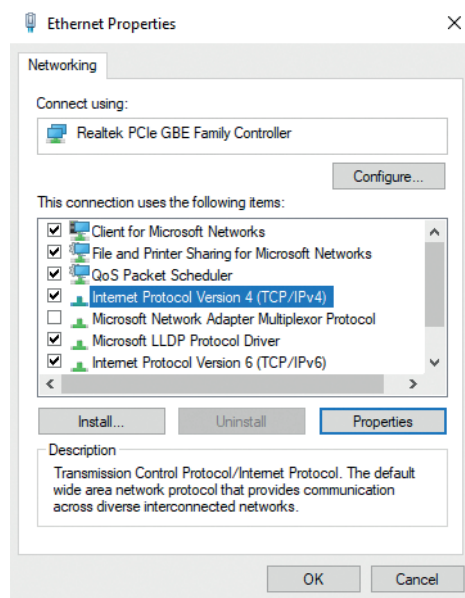

Fig. 32 LAN-Connection of a PC

➡ Define the following address in the properties of the LAN connection:
 IP address: 169.254.168.1
 Subnet mask: 255.255.0.0



➡ Select Properties.



➔ Select Internet Protocol (TCP/IP) > Properties.

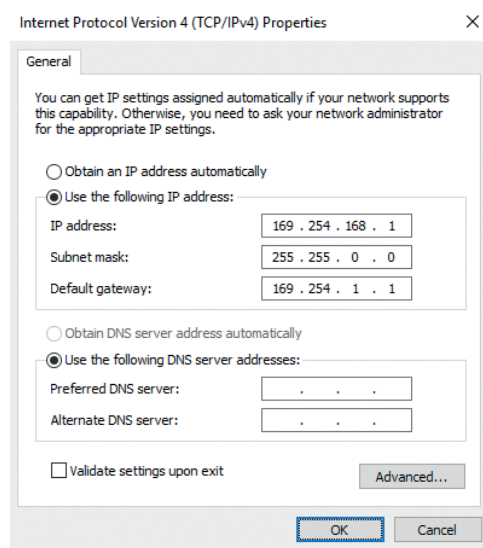

i In order to be able to use the Ethernet interface, there must be a demodulator module in channel 1 as this one determines the cycle for all channels!

By default, the IP address of the controller is set to 169.254.168.150. Communication with the controller is done on the data port 10001 for measurement transmission. A command port (Telnet, port 23) is used for sensor commands.

The IP settings and the data port can be changed at any time:

- by using the web browser. Enter the current IP address into the address bar. Go to the menu `Settings > Digital Interfaces > Ethernet settings` to set a new IP address, activate DHCP or change the data port.
- by using software commands, see 6.4.
- by using the `sensorTOOL` software.

If you activate DHCP, access to the controller via a DHCP host name is possible. The host name contains the device name and serial number. Structure: `NAME_SN` e. g. `DT6530_1001`.

The controller supports UPnP. If you use an operational system with activated UPnP client e. g. standard with Windows 7, the controller is listed in the explorer as a device automatically. This is helpful, if you do not know the IP address of the controller.

6.2 Data Format of Measuring Values

The measuring value is made up of 4 consecutive bytes:

	MSB							LSB
	Bit 1	Bit 2	Bit 3	Bit 4	Bit 5	Bit 6	Bit 7	Bit 8
1. Byte	1 (Start)	Channel number (1 ... 8)			Vz-Bit	MSB		
2. Byte	0	24-Bit Measuring value						LSB
3. Byte	0							
4. Byte	0							

Vz-Bit: (0 = positive numbers, 1 = negative numbers at math functions)

Negative numbers are displayed in two's complement.

If a math function is active, the measured value on this channel reduces from 24 bit to 21 bit. The three upper bits now provide to display measured values, which exceed the measuring range (For example if two measured values are added).

By default, the measurements are continuously output with the set data rate via the data port. However, there is also a trigger mode which can be used to get the individual measurements, [see 5.5](#).

6.3 Settings

Operating modes:

- Continuous transmission with fixed data rate
- Trigger mode (recall hardware trigger input or individual measurements, [see 5.5](#)).

Data rate:

It is possible to adjust different data rates between 2.5 Sa and 7.8 kSa (resp. 3.9 kSa). The data rate applies to all channels.

Filter/Measuring value averaging:

The following filters are selectable:

- Moving average
- Arithmetic average (only each n^{th} value will be output)
- Median
- Dynamic Noise Rejection

The setting for the averaging applies to all channels.

Channel selection:

Only selected channels will be transmitted.

Linearization Options:

- Offset correction
- 2-point-linearization
- 3-point-linearization
- 5-point-linearization
- 10-point-linearization

Up to 10 linearization points can be measured for each channel. These are at 10 %, 20 %, 30 %, 40 %, 50 %, 60 %, 70 %, 80 %, 90 % and 100 % of the measurement range. That means, for example, that the sensor is adjusted to 10 % of the measurement range. This linearization point (= actual measurement at this point) is then measured and a correction curve is calculated so that the linearized measured value corresponds to the target measurement value.

Only the measurement value at 10 % of the measurement range is used for the correction of the start of the measurement range.

The correction curve for the 2-point-linearization uses data points at 10 % and 90 % of the measurement range.

The two correction curves for the 3-point-linearization use restart points at 10 % and 50 %, 50 % and 90 % of the measurement range.

The four correction curves for the 5-point-linearization use data points at 10 % and 30 %, 30 % and 50 %, 50 % and 70 %, 70 % and 90 % of the measurement range.

The nine correction curves for the 10-point-linearization use data points at 10 %, 20 %, 30 %, 40 %, 50 %, 60 %, 70 %, 80 %, 90 % and 100 % of the measurement range.

The linearization function allows an individual adjustment

- of the start of the measurement range,
- slope of the characteristic curve (Gain).

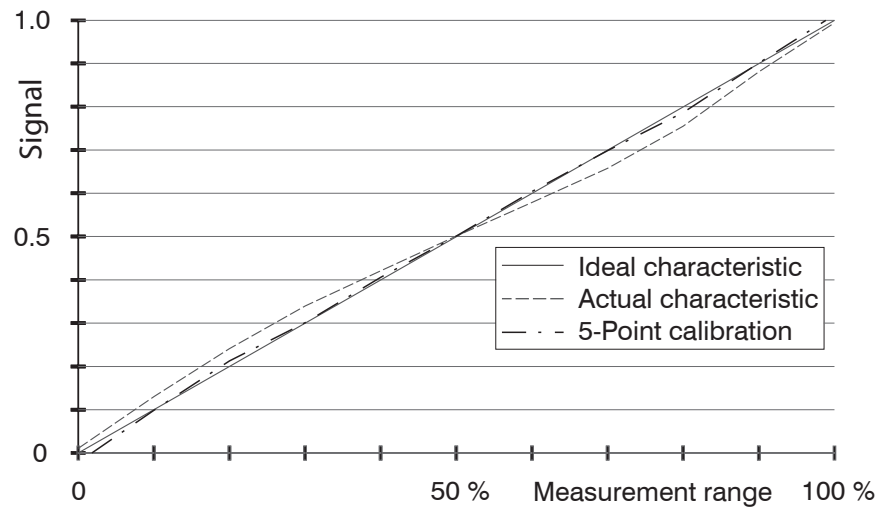

Fig. 33 Output characteristic for the measurement against an insulator material

The software linearization affects only the values (averaging also), which are output via the Ethernet and EtherCAT interface.

Math functions:

For calculation of several channels.

6.4 Commands

All commands are transmitted via port 23 (Telnet). Each command starts with a \$ character. The controller ignores all characters, which are transmitted before the \$ character.

The controller immediately returns all transmitted characters back as echo.

After the response has been sent, the controller starts to send measurement values gain (applies to the operating mode "continuous transmission").

Commands are transmitted in ASCII format.

Except for the linearization types and points, the respective settings are the same for all eight channels.

A timeout is reached approximately 10 seconds after the last character input.

Channel numbers are separated by a comma, channel number and a parameter belonging to the channel by a colon.

Several successive different parameters (for the command STS and VER) are separated by a semicolon.

Commands always have to end with <CR> or <CRLF>.

6.4.1 Data Rate (SRA = Set Sample Rate)

Changes the data rate for all channels which are used to transmit the measurement values.

	SRA = Set Sample Rate
Command	\$SRAn<CR>
Response	\$SRAnOK<CRLF>
Index	n = 0...13
Request data rate	
Command	\$SRA?<CR>
Response	\$SRA?nOK<CRLF>

Index n	Data rate
0	2.60 Sa/s
1	5.21 Sa/s
2	10.42 Sa/s
3	15.63 Sa/s
4	26.04 Sa/s
5	31.25 Sa/s
6	52.08 Sa/s
7	62.5 Sa/s
8	104.17 Sa/s
9	520.83 Sa/s
10	1041.67 Sa/s
11	2083.33 Sa/s
12	3906.25 Sa/s
13	7812.5 Sa/s
?	Request data rate

Fig. 34 Adjustable data rate

The maximum data rate with 7812 Sa/s is possible, if the controller contains 4 channels as a maximum. They always have to be located within the first 4 slots. The data rate is 3900 Sa/s, if you use more than 4 channels.

6.4.2 Trigger Mode (TRG)

If the trigger mode is turned off, the capaNCDT 6500 will send the measurement values without interruption and with the adjusted data rate.

There are three possible settings regarding the trigger input, [see 5.5](#). Irrespective of the trigger mode set, a single measured value per channel can be called up by means of a software command, [see 6.4.3](#).

	TRG
Command	\$TRGn<CR>
Response	\$TRGnOK<CRLF>
Index	n = 0: Continuous transmission (default setting) n = 1: Trigger mode 1 (rising edge) n = 2: Trigger mode 2 (high level) n = 3: Trigger mode 3 (gate rising edge) ? = Request trigger mode
Request trigger mode	
Command	\$TRG?<CR>
Response	\$TRG?nOK<CRLF>

6.4.3 Get Measured Data (GMD)

In the trigger mode, one measured data is transmitted per channel.

	GMD
Command	\$GMD<CR>
Response	\$GMDOK<CRLF> + Measuring value in binary mode (format as in operating mode "continuous transmission")

6.4.4 Averaging Type (AVT)

Mode of measurement averaging

	AVT
Command	\$AVTn<CR>
Response	\$AVTnOK<CRLF>
Index	n = 0: No averaging (default setting) n = 1: Moving average n = 2: Arithmetic average (output only each nth measured value) n = 3: Median n = 4: Dynamic Noise Rejection ? = Request averaging type
Request averaging type	
Command	\$AVT?<CR>
Response	\$AVT?nOK<CRLF>

Moving average

The average value M_{gl} is derived and output via the selectable number N of successive measured values according to the following formula.

$$M_o = \frac{\sum_{k=1}^N MW(k)}{N}$$

Fig. 35 Formula for the moving averaging value

- MW = Measuring value
- N = Number
- k = Index
- Mo = Average value

Method

Each new measuring value is added, the first (oldest) measuring value will be taken out from the averaging.

Example with N = 7:

.... 0 1 2 3 4 5 6 7 8 gets to $\frac{2+3+4+5+6+7+8}{7}$ Average value n

.... 1 2 3 4 5 6 7 8 9 gets to $\frac{3+4+5+6+7+8+9}{7}$ Average value n + 1

Arithmetic average

The average value M is derived and output via the selectable number N of successive measuring values.

Method

Measured values are collected and averaged. The method reduces the data volume because an average value is output only after each nth measuring value.

Example with N = 3:

... 0 1 2 3 4... gets to $\frac{2+3+4}{3}$ Average value n

... 3 4 5 6 7... gets to $\frac{5+6+7}{3}$ Average value n + 1

Median

The Median is formed from a pre-selected number N of measuring values. The incoming measuring values are sorted anew after each measurement. The medial value is then output as the Median.

If an even numbered value has been selected for the averaging number N, the two middle measuring values will be added and divided by two.

Example with N = 7:

... 2 4 0 1 2 4 5 1 3 Measuring value sorted 0 1 1 2 3 4 5 Median $n = 2$

... 4 0 1 2 4 5 1 3 4 Measuring value sorted 1 1 2 3 4 4 5 Median $n + 1 = 3$

6.4.5 Dynamic Noise Rejection

This filter removes the noise of the measurement signal completely, but keeps the original bandwidth of the measurement signal. For that purpose the signal noise is calculated dynamically and measurement changes are only transferred, if they exceed this calculated noise. Thereby at a change in direction of the measurement signal small hysteresis effects in the size of the calculated noise can occur.

6.4.6 Averaging Number (AVN)

Number of measuring values used to calculate the average (adjustable from 2 ... 8).

	AVN
Command	\$AVNn<CR>
Response	\$AVNnOK<CRLF>
Index	n = 2 ... 8 ? = Request averaging number
Request averaging number	
Command	\$AVN?<CR>
Response	\$AVN?nOK<CRLF>

6.4.7 Channel Status (CHS)

Specifies in increasing order in which channels there is a module. (0 = no channel available, 1 = channel available, 2 = math function is output on this channel)

	CHS
Command	\$CHS<CR>
Response	\$CHS1,0,2,1,1,1,0,0OK<CRLF> (Example: Channel 1,3,4,5,6 available, channel 3 with math function))

6.4.8 Channel Transmit (CHT)

Specifies the channels to be transmitted.

(0 = Do not transmit channel, 1 = Transmit channel)

	CHT
Command	For example \$CHT1,1,0,0,1,0,0,0<CR>
Response	\$CHT1,1,0,0,1,0,0,0OK<CRLF> (Example: Channel 1,2 und 5 are transmitted)
Request channel transmit	
Command	\$CHT?<CR>
Response	\$CHT?1,1,0,0,1,0,0,0 OK<CRLF>

Added zeros can be omitted for simplification. For example \$CHT1 ,0,0,1,0,0,0,0 can be replaced by \$CHT1,0,0,1.

6.4.9 Mode of Linearization (LIN)

Specifies the linearization type for each channel.

The linearization type can be set for each channel. The index m stands for channel number, the index n for the linearization type.

	LIN
Command	\$LINm:n<CR> (for example: \$LIN5:2<CR> = 2-point-linearization for channel 5)
Response	\$LINm:nOK<CRLF>
Index m (Channel number)	1 ... 8
Index n (linearization mode)	0 = no linearization (Default setting) 1 = Start of measuring range 2 = 2-point-linearization 3 = 3-point-linearization 4 = 5-point-linearization 5 = 10-point-linearization
Request linearization mode	
Command	\$LIN?<CR>
Response	\$LIN?n,n,n,n,n,n,n,nOK<CRLF> (n stands for the linearization type)

6.4.10 Set Linearization Point (SLP)

Sets a linearization point.

Place the sensor or the target in the corresponding position. After the command has been received, the current measuring value will be recorded at this position as a linearization point and thus the constants are recalculated for the linearization.

	SLP
Command	\$SLPm:n<CR> (for example: \$SLP5:3<CR> =linearization point at 30 % of channel 5)
Response	\$SLPm:nOK<CRLF>
Index m (Channel number)	1 ... 8
Index n (point of linearization)	n (linearization point): 1 = linearization point at 10 % of the measuring range 2 = linearization point at 20 % of the measuring range 3 = linearization point at 30 % of the measuring range 4 = linearization point at 40 % of the measuring range 5 = linearization point at 50 % of the measuring range 6 = linearization point at 60 % of the measuring range 7 = linearization point at 70 % of the measuring range 8 = linearization point at 80 % of the measuring range 9 = linearization point at 90 % of the measuring range 10 = linearization point at 100 % of the measuring range

6.4.11 Get Linearization Point (GLP)

Reads out the linearization point.

The value is output as a 6-digit number in hex format (000000 to FFFFFFFF).

	GLP
Command	\$GLPm:n<CR> (for example: \$GLP5:3<CR> = linearization point at 30 % of channel 5)
Response	\$GLPm:n,.....OK<CRLF> (zum Beispiel \$GLP5:3,A034C9OK<CRLF>)
Index	m (Channel number): 1...8 n (linearization point): 1 = linearization point at 10 % of the measuring range 2 = linearization point at 20 % of the measuring range 3 = linearization point at 30 % of the measuring range 4 = linearization point at 40 % of the measuring range 5 = linearization point at 50 % of the measuring range 6 = linearization point at 60 % of the measuring range 7 = linearization point at 70 % of the measuring range 8 = linearization point at 80 % of the measuring range 9 = linearization point at 90 % of the measuring range 10 = linearization point at 100 % of the measuring range

6.4.12 Status (STS)

Reads all settings at once.

The individual parameters are separated by a semicolon. The structure of the respective responses corresponds to those of the individual requests.

	STS
Command	\$STS<CR>
Response	\$STSSRAn;AVTn;AVNn;CHS...;CHT...;TRG.;LINn,n,n,n,n,n,n,n;DISa,bOK<CRLF>

6.4.13 Version (VER)

Requesting the current software version including date.

	VER
Command	\$VER<CR>
Response	\$VERDT6500;V1.2a;8010074<CRLF>

6.4.14 Display Setups (DIS)

Defines

- which values are shown on the display (linearized or non-linearized values)
- which channels are updated on the display.

	DIS
Command	\$DISa,b<CR>
Response	\$DISa,bOK<CRLF>
Index	a (Display update): 1 = All channels are updated (Default setting) 2 = Only the channels to be transmitted are updated 0 = No channels are updated b (Display values): 0 = Non-linearized measuring values are displayed (Default setting) 1 = Linearized measuring values are indicated
Request display settings	
Command	\$DIS?<CR>
Response	\$DIS?a,bOK<CRLF>

6.4.15 Load Factory Setting (FDE)

Loads the factory setting.

	FDE
Command	\$FDE<CR>
Response	\$FDESRAn;AVTn;AVNn;CHS...;CHT...;TRG.;LINn,n,n,n,n,n,n,n;DISa,bOK<CRLF>

Factory settings:

- Data rate = 100 Sa
- Filter = Off
- Linearization = Off
- Transmit channels = All
- Trigger mode = Off
- Display = All channels, non-linearized measuring values
- Math functions = Off

6.4.16 SMF = Set Mathematic Function (SMF)

Sets a math function on a certain channel.

	SMF	
Command	\$SMFm:Offset,Factor1,Factor2,Factor3,Factor4,Factor5,Factor6,Factor7,Factor8<CRLF>	
Response	\$SMFm:Offset,Factor1,Factor2,Factor3,Factor4,Factor5,Factor6,Factor7,Factor8OK<CRLF>	
Index	m: 1...8 (Channel number)	If a channel is selected, which is already reserved by electronics, the result of the math function is now transmitted instead of the measured value.
	Offset	24 bit offset value with prefix in hex format, at which 21 bit comply with 100 % measured value. Numbers exceeding 21 bit are therefore greater (for example +3FFFF = complies with 200 % of the measured value).
	Factor1, ..., Factor8	Multiplication factors (including prefix), with which the measured values of channel 1 up to 8 are multiplied. The range of values of -9.9 up to +9.9 with a decimal place. Structure of factors: Prefix and a one-digit number with a decimal place.

Example: \$SMF2: +1FFFFF, +1.0, +0.0, +0.0, -0.3, +8.8, +0.0, +0.0, +0.0<CRLF>
On channel 2 the sequent math function is output:

```
100 % Offset + 1 * channel 1 - 0.3 * channel 4 + 8.8 * channel 5
```

i 3 measured values can be allocated together at most, the different factors have to be +0.0 each.
As soon as a math function is active, the scaling of the measured values changes for this channel. 100 % measuring range complies with 21 bit instead of 24 bit now. If the result is exceeds 21 bit, the 3 upper bits are used according for it.

If a math function is set on a channel, the channel status changes onto 2.

The result of the math function only is output via an Ethernet interface, it is neither shown on the display of the DD6530 nor output as an analog signal.

6.4.17 Get Mathematic Function (GMF)

Reads out the math function of a channel.

	GMF	
Command	\$GMFm<CRLF>	
Response	\$GMFm:Offset,Factor1,Factor2,Factor3,Factor4,Factor5,Factor6,Factor7,-Factor8OK<CRLF>	
Index	m: 1...8 (Channel number)	If a channel is selected, which is already reserved by electronics, the result of the math function is now transmitted instead of the measured value.
	Offset	24 bit offset value with prefix in hex format, at which 21 bit comply with 100 % measured value. Numbers exceeding 21 bit are therefore greater (for example +3FFFF = complies with 200 % of the measured value).
	Factor1, ..., Factor8	Multiplication factors (including prefix), with which the measured values of channel 1 up to 8 are multiplied. The range of values of -9.9 up to +9.9 with a decimal place. Structure of factors: Prefix and a one-digit number with a decimal place.

6.4.18 Clear Mathematics Function (CMF)

Deletes the math function on a channel.

	CMF	
Command	\$CMFm<CRLF>	
Response	\$CMFmOK<CRLF>	
Index	m: 1...8 (Channel number)	

6.4.19 Ethernet Settings (IPS = IP-Settings)

Changes the IP settings of the controller.

	IPS	
Command	\$IPSm,<IPAddress>,<SubnetAddress>,<Gateway><CRLF>	
Example	\$IPSO,169.254.168.150,255.255.0.0,169.254.168.1<CRLF>	
Response	\$IPSm,<IPAddress>,<SubnetAddress>,<Gateway>OK<CRLF>	
Index	m = 0: static IP Address m = 1: activates DHCP* * If DHCP is active, no IP, subnet and gateway address has to be transmitted.	
Request settings		
Command	\$IPS?	
Response	\$IPS? m,<IPAddress>,<SubnetAddress>,<Gateway>OK<CRLF>	

6.4.20 Change between Ethernet and EtherCAT (IFC = Interface)

Command switches between Ethernet and EtherCAT interface. Effective only, if the switch `Ethernet/EtherCAT` is in the position `ECAT/Auto`. Otherwise always the Ethernet interface is active. The new interface is activated after a restart of the controller.

	IFC	
Command	\$IFCm<CRLF> Example: \$IFC1<CRLF>	
Response	\$IFCmOK<CRLF>	
Index	m = 0: Ethernet m = 1: EtherCAT	
Request		
Command	\$IFC?	
Response	\$IFC?mOK<CRLF>	

6.4.21 Query Data Port (GDP = Get Dataport)

Queries the port number of the data port.

Command	\$GDP<CRLF>
Response	\$GDP<Portnumber>OK<CRLF> Example: \$GDP10001OK<CRLF>

6.4.22 Set Data Port (SDP = Set Dataport)

Sets the port number of the data port. Range: 1024 ...65535.

Command	\$SDP<Portnumber><CRLF> Example: \$SDP10001OK<CRLF>
Response	\$SDP<Portnumber>OK<CRLF>

6.4.23 Access Channel Information (CHI = Channel info)

Reads channel-specific information (e.g. serial number of the display board).

Command	\$CHIm<CR>
Response	\$CHIm:ANO...,NAM...,SNO...,OFS...,RNG...,UNT...,DTY...OK<CRLF>
Index	m (Channel number): 1 - 8 ANO = Article number NAM = Name SNO = Serial number OFS = Measuring range offset RNG = Measuring range UNT = Unit of measuring range (e.g. μm) DTY = Data type of measuring values (1 = measuring value as INT, 0 = no measuring value)

6.4.24 Access Controller Information (COI = Controller info)

Reads information of the controller (e.g. serial number).

Command	\$COI<CR>
Response	\$COIANO...,NAM...,SNO...,OPT...,VER...OK<CRLF>
Index	ANO = Article number NAM = Name SNO = Serial number OPT = Option VER = Firmware version

6.4.25 Login for Web Interface (Lgl = Login)

Changes the user level for the web interface on `professional`.

Command	\$LGI<Password><CR>
Response	\$LGI<Password><OK>CRLF
Index	Password = Password of the device. When delivered, no password is assigned. The field can remain empty.

6.4.26 Logout for Web Interface (LGO = Logout)

Changes the user level for the web interface on `user`.

Command	\$LGO<CR>
Response	\$LGOOK<CRLF>

6.4.27 Change Password (PWD = Password)

Changes the password of the device (required for the web interface and the `sensor-TOOL`).

Command	\$PWD<oldpassword>,<newpassword>,<newpassword><CR>
Response	\$PWD<oldpassword>,<newpassword>,<newpassword>OK<CRLF> A password can be from 0-16 characters and must contain only letters and numbers. When delivered, no password is assigned. The field can remain empty/blank.

6.4.28 Change Language for the Web Interface (LNG = Language)

Changes the language of the web interface.

Command	\$LNGn<CR>
Response	\$LNGnOK<CRLF>
Index	0 = System 1 = English 2 = German

6.4.29 Write Measuring Range Information in Channel (MRA = Measuring Range)

Changes the measuring range information of a channel (e.g. in case of a sensor change). This information is e.g. required for the correct scaling of the measuring values in the web interface. The value is specified in μm .

This is only an information value, what means, the actual measuring range of a sensor is not changed by changing the value.

Command	\$MRAm:<Range in μm ><CR> (Example: \$MRA2:2000<CR> sets the measuring range of channel 2 to 2000 μm)
Response	\$MRAm:<Range in μm >OK<CRLF>
Index	m (Channel number): 1 - 8

6.4.30 Default Messages

- Unknown command: (ECHO) + \$UNKNOWN COMMAND<CRLF>
- Wrong parameter after command: (ECHO) + \$WRONG PARAMETER<CRLF>
- Timeout (approximately 15 s after last input) (ECHO) + \$TIMEOUT<CRLF>
- No channel 1: \$ERROR NO CH1<CRLF>
- Data rate to high: \$ERROR DATARATE TO HIGH<CRLF>
- Wrong password: \$WRONG PASSWORD<CRLF>

6.5 Control via Ethernet



Dynamic web pages are generated in the controller which contain the current settings of the controller and the peripherals. Operation is only possible while there is an Ethernet connection to the controller.

6.5.1 Requirements

You need a web browser with HTML5 support (e.g. Mozilla Firefox ≥ 3.5 or Internet Explorer ≥ 10) on a PC with a network connection. To support a basic first commissioning of the controller, the controller is set to a direct connection.

If you have configured your browser to access the internet via a proxy server, in the browser settings you will need to add the IP address of the controller to the list of addresses which should not be routed through the proxy server. The MAC address of the unit can be found on the nameplate of the controller.

“Javascript” must be enabled in the browser so that measurement results can be displayed graphically.

Direct connection to PC, controller with static IP (Factory setting)		Network
PC with static IP	PC with DHCP	Controller with dynamic IP, PC with DHCP
<p>➔ Connect the controller to a switch (intranet). Use a LAN cable with RJ-45 connectors.</p>		<p>➔ Connect the controller to a switch (intranet). Use a LAN cable with RJ-45 connectors.</p>
<p>➔ Now start the <code>sensorTOOL</code> program.</p> <p>➔ Click the  button. Select the designated controller from the list. In order to change the address settings, click the button <code>Change IP...</code></p> <ul style="list-style-type: none"> • Address type: static IP address • IP address: 169.254.168.150 ¹ • Subnet mask: 255.255.0.0 <p>➔ Click the button <code>Apply</code> to transmit the changes to the controller.</p> <p>➔ Click the button <code>Open WebPage</code> to connect the controller with your default browser.</p> <p>1) Requires that the LAN connection on the PC uses, for example, the following IP address: 169.254.168.1.</p>	<p>Wait until Windows has established a network connection (Connection with limited connectivity).</p> <p>➔ Now start the <code>sensor-TOOL</code> program.</p> <p>➔ Click the  button. Select the designated controller from the list.</p> <p>➔ Click the button <code>Open WebPage</code> to connect the controller with your default browser.</p>	<p>➔ Enter the controller in the DHCP / register the controller in your IT department.</p> <p>The controller gets assigned an IP address from your DHCP server. You can check this IP address with the <code>sensorTOOL</code> program.</p> <p>➔ Now start the <code>sensorTOOL</code> program.</p> <p>➔ Click the  button. Select the designated controller from the list.</p> <p>➔ Click the button <code>Open WebPage</code> to connect the controller with your default browser.</p> <p>Alternatively: If DHCP is used and the DHCP server is linked to the DNS server, access to the controller via a host name of the structure “DT6530_<serial_number>” is possible.</p> <p>➔ Start a web browser on your PC. To achieve a controller with the serial number “01234567”, type in the address bar on your browser “DT6530_01234567”.</p>
<p>Interactive web pages for setting the controller and peripherals are now shown in the web browser.</p>		

The `sensorTOOL` program is available online at <https://www.micro-epsilon.com/download/software/sensorTool.exe>.

6.5.2 Access via Web Interface

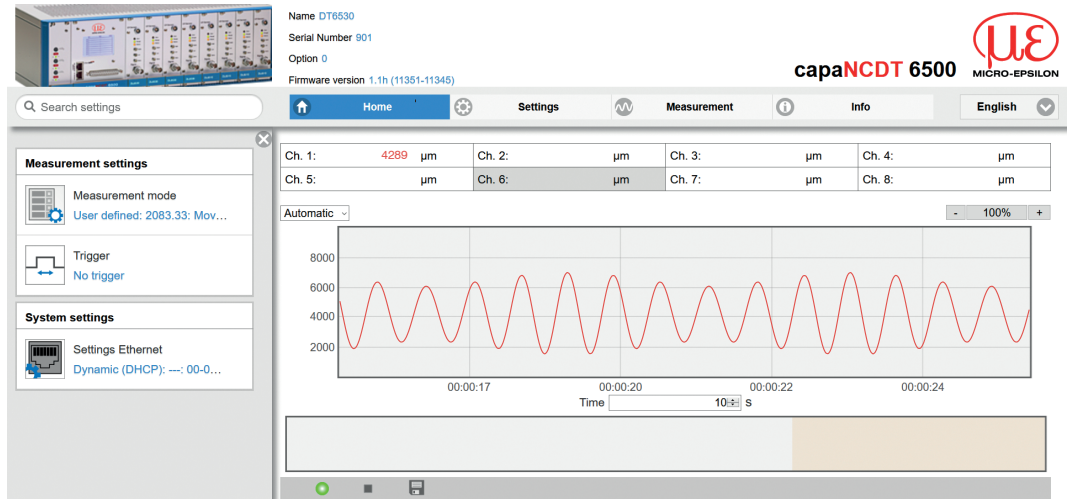

Fig. 36 First interactive web page after calling the IP address

Use the upper navigation bar to access additional features (e. g. settings). All settings on the web page are applied immediately in the controller.

Parallel operation with web interface and Telnet commands is possible; the last setting applies.

The appearance of the web pages may vary depending on functions and peripherals. Each page contains parameter descriptions and tips on completing the controller.

6.6 Firmware Update

The controller has a firmware update function. We recommend to always use the latest firmware version. You can find the latest firmware version on our website and it can be installed with the attached Firmware Update Tool.

7. EtherCAT Interface

7.1 Introduction

The EtherCAT interface allows a fast transfer of measured values. The controller supports CANopen over EtherCAT (CoE).

Service Data Objects SDO: All parameters of the controller can thus be read or modified.

Process Data Objects PDO: A PDO telegram is used for real-time transmission of measured values. Individual objects are not addressed. The content of the previously selected data is transmitted.

The displacement values are transmitted as 32 bit signed integer.

7.2 Change Interface

You can not change directly to the EtherCAT interface through the web interface or command. Restart your controller to do this. Keep in mind also that the setting of the EtherCAT switch is in the correct position, see Fig. 37.

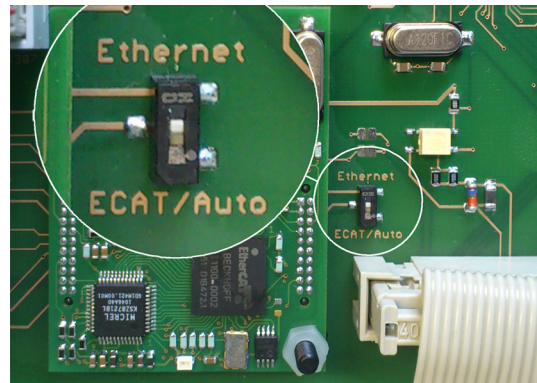

Switch position	Meaning
Ethernet	Regardless to the software setting always the Ethernet interface is active.
ECAT/Auto	Active interface, which is set via the web interface or command.

Fig. 37 Switch to change the interface

A change from the EtherCAT interface back to the Ethernet interface is possible with the hardware switch on the DD6530 display board or via the corresponding CoE Object. In both cases, then a restart of the controller is required.

To integrate the EtherCAT interface e.g. within TwinCAT an ESI-file is supplied.

You will find further instructions in the appendix, see A 5.

8. Operation and Maintenance



Disconnect the power supply before touching the sensor surface.

- > static discharge
- > danger of injury

Please take care of the following:

- Make sure that the sensor surface is always clean.
- Switch off the power supply before cleaning.
- Clean with a damp cloth; then rub the sensor surface dry.

Changing the target or very long operating times can lead to slight reductions in the operating quality (long term errors). These can be eliminated by recalibration, see 5.3, see 5.4.

In the event of a defect in the controller, the preamplifier, the sensor or the sensor/preamplifier cable, the parts concerned must be sent back for repair or replacement.

In the case of faults the cause of which is not clearly identifiable, the whole measuring system must be sent back for repair or replacement to

MICRO-EPSILON MESSTECHNIK
 GmbH & Co. KG
 Koenigbacher Str. 15
 94496 Ortenburg / Germany

9. Disclaimer

All components of the device have been checked and tested for functionality in the factory. However, should any defects occur despite careful quality control, these shall be reported immediately to MICRO-EPSILON or to your distributor / retailer.

MICRO-EPSILON undertakes no liability whatsoever for damage, loss or costs caused by or related in any way to the product, in particular consequential damage, e.g., due to

- non-observance of these instructions/this manual,
- improper use or improper handling (in particular due to improper installation, commissioning, operation and maintenance) of the product,
- repairs or modifications by third parties,
- the use of force or other handling by unqualified persons.

This limitation of liability also applies to defects resulting from normal wear and tear (e.g., to wearing parts) and in the event of non-compliance with the specified maintenance intervals (if applicable).

MICRO-EPSILON is exclusively responsible for repairs. It is not permitted to make unauthorized structural and / or technical modifications or alterations to the product. In the interest of further development, MICRO-EPSILON reserves the right to modify the design.

In addition, the General Terms of Business of MICRO-EPSILON shall apply, which can be accessed under Legal details | Micro-Epsilon <https://www.micro-epsilon.com/impresum/>.

10. Decommissioning, Disposal

In order to avoid the release of environmentally harmful substances and to ensure the reuse of valuable raw materials, we draw your attention to the following regulations and obligations:



- Remove all cables from the sensor and/or controller.
- Dispose of the sensor and/or the controller, its components and accessories, as well as the packaging materials in compliance with the applicable country-specific waste treatment and disposal regulations of the region of use.
- You are obliged to comply with all relevant national laws and regulations.

For Germany / the EU, the following (disposal) instructions apply in particular:

- Waste equipment marked with a crossed garbage can must not be disposed of with normal industrial waste (e.g. residual waste can or the yellow recycling bin) and must be disposed of separately. This avoids hazards to the environment due to incorrect disposal and ensures proper recycling of the old appliances. 
- Waste equipment marked with a crossed garbage can must not be disposed of with normal industrial waste (e.g. residual waste can or the yellow recycling bin) and must be disposed of separately. This avoids hazards to the environment due to incorrect disposal and ensures proper recycling of the old appliances.
- A list of national laws and contacts in the EU member states can be found at https://ec.europa.eu/environment/topics/waste-and-recycling/waste-electrical-and-electronic-equipment-weee_en. Here you can inform yourself about the respective national collection and return points.
- Old devices can also be returned for disposal to MICRO-EPSILON at the address given in the imprint at <https://www.micro-epsilon.com/impresum/>.
- We would like to point out that you are responsible for deleting the measurement-specific and personal data on the old devices to be disposed of.
- Under the registration number WEEE-Reg.-Nr. DE28605721, we are registered at the foundation Elektro-Altgeräte Register, Nordostpark 72, 90411 Nuremberg, as a manufacturer of electrical and/or electronic equipment.

Appendix

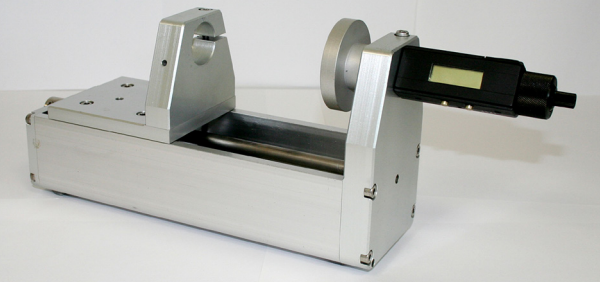
A 1 Optional Accessory

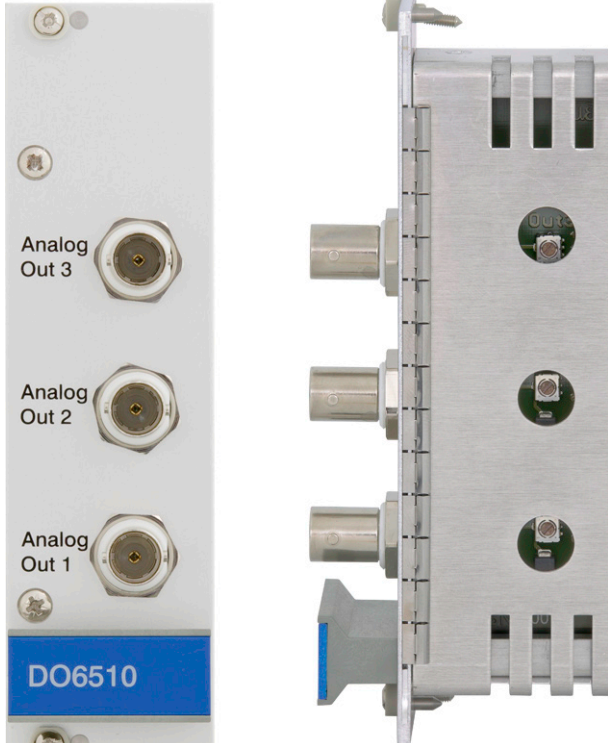
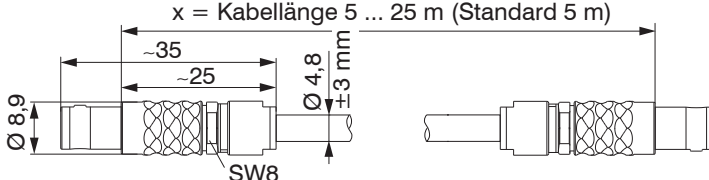
MC2.5		Micrometer calibration device, setting range 0 - 2.5 mm, reading 0.1 μm , f or sensors S 601-0.05 to CS 2
MC25D		Digital micrometer calibration device, setting range 0 - 25 mm, adjustable zero-point, for all sensors
SC3100-x		Synchronization cable, cable length x = 0.3 or 1 m
DO6510		Analog output card, 3 channels with 0 ... 10 V, ± 5 V or 4 ... 20 mA, digital resolution 16 bit
CA5		Pre-amplifier cable CA5 5-pin,

Vacuum feedthroughs

All vacuum feedthroughs are compatible with type B connectors, see Chap. 4.3 Dimensions in mm, not to scale.

<p>SWH.OS.650.CTMSV</p>	<p>Leak rate <math>< 1 * 10e-7 \text{ mbar} * \text{l} / \text{s}</math></p>	<p>Vacuum feed through, Max. leak rate $1 \times 10e-7 \text{ mbar} \cdot \text{l s}^{-1}$ Compatible with connector type B</p>
<p>UHV/B</p>		<p>Vacuum feed through triax weld-able Max. leak rate $1 \times 10e-9 \text{ mbar} \cdot \text{l s}^{-1}$ Compatible with connector type B</p> <p>Vacuum feed through triax with CF16 flange Max. leak rate $1 \times 10e-9 \text{ mbar} \cdot \text{l s}^{-1}$ Compatible with connector type B</p> <p>Vacuum feed through triax screwable Max. leak rate $1 \times 10e-9 \text{ mbar} \cdot \text{l s}^{-1}$ Compatible with connector type B</p>

A 2 Services

Function and linearity check-out, inclusive 11-point-protocol with graphic and post-calibration.

A 3 Factory Setting

- Data rate = 100 Sa/s
- Filter = Off
- Linearization = Off
- Transmit channels = All
- Trigger mode = Off
- Display = All channels, non-linearized measuring values
- Math functions = Off

A 4 Tilt Angle Influence on the Capacitive Sensor

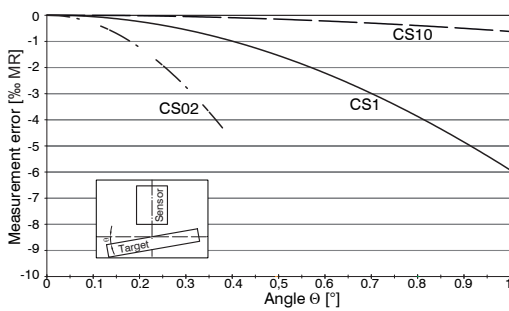

Fig. 38 Example of measuring range deviation in the case of a sensor distance of 10 % of the measuring range

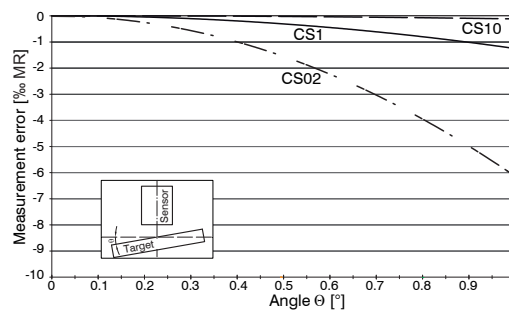

Fig. 39 Example of measuring range deviation in the case of a sensor distance of 50 % of the measuring range

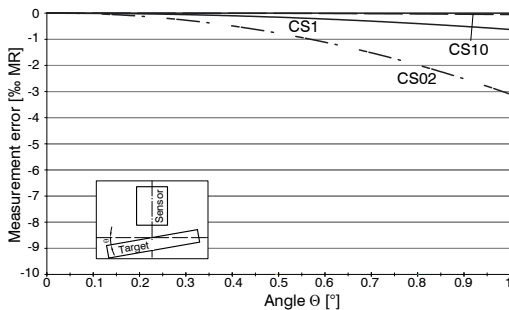

Fig. 40 Example of measuring range deviation in the case of a sensor distance of 100 % of the measuring range

Figures give an influence example shown on the sensors CS02/CS1 and CS10 in the case of different sensor distances to the target. As this results from internal simulations and calculations, please request for detailed information.

A 4.1 Measurement on Narrow Targets

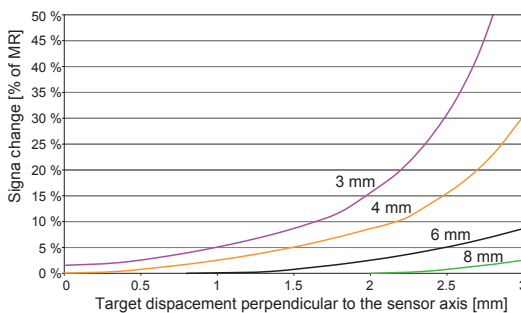

Fig. 41 Example of measuring range deviation in the case of a sensor distance of 10 % of the measuring range

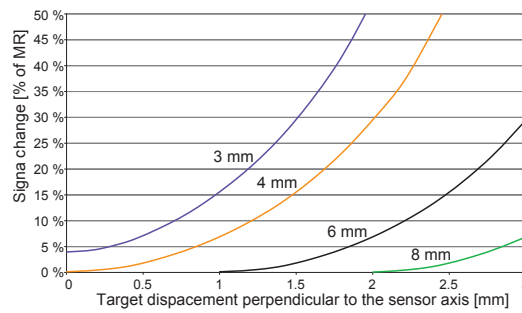

Fig. 42 Example of measuring range deviation in the case of a sensor distance of 50 % of the measuring range

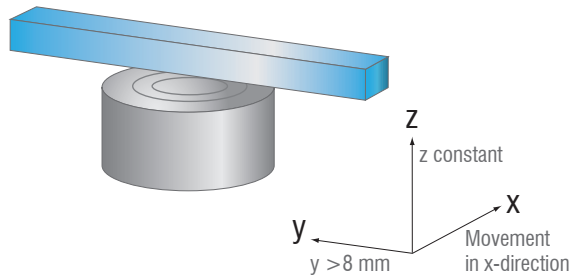
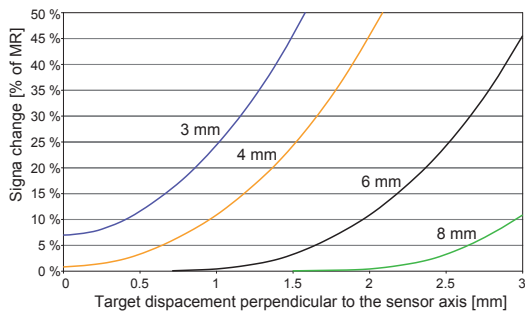

Fig. 43 Example of measuring range deviation in the case of a sensor distance of 100 % of the measuring range

Fig. 44 Signal change in the case of displacement of thin targets in the opposite direction to the measurement direction

Figures give an influence example shown on the sensors CS05 in the case of different sensor distances to the target as well as target widths. As this results from internal simulations and calculations, please request for detailed information.

A 4.2 Measurements on Balls and Shafts

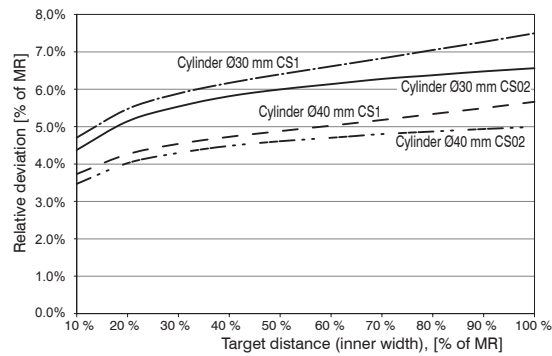
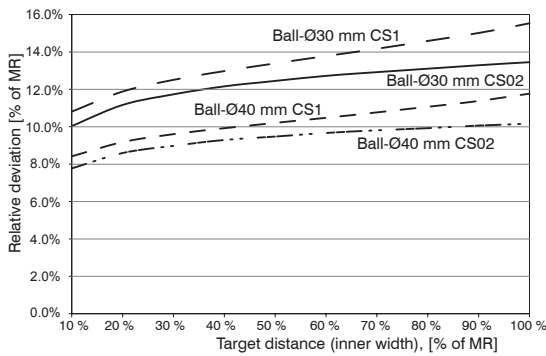

Fig. 45 Measuring value deviation in the case of measurement on ball-shaped targets

Fig. 46 Measuring value deviation in the case of measurement on cylindrical targets

Figures give an influence example shown on the sensors CS02 and CS1 in the case of different sensor distances to the target as well as target diameters. As this results from internal simulations and calculations, please request for detailed information.

A 5 EtherCAT Documentation

EtherCAT® is, from the Ethernet viewpoint, a single, large Ethernet station that transmits and receives Ethernet telegrams. Such an EtherCAT system consists of an EtherCAT master and up to 65535 EtherCAT slaves.

Master and slaves communicate via a standard Ethernet wiring. On-the-fly processing hardware is used in each slave. The incoming Ethernet frames are directly processed by the hardware. Relevant data are extracted or added from the frame. The frame is subsequently forwarded to the next EtherCAT® slave device. The completely processed frame is sent back from the last slave device. Various protocols can be used in the application level. CANopen over EtherCAT technology (CoE) is supported here. In the CANopen protocol, an object tree with Service Data Objects (SDO) and Process Data Objects (PDO) is used to manage the data.

Further information can be obtained from ® Technology Group (www.ethercat.org) or Beckhoff GmbH, (www.beckhoff.com).

A 5.1 Preamble

A 5.1.1 Structure of EtherCAT®-Frames

The transfer of data occurs in Ethernet frames with a special Ether type (0x88A4). Such an EtherCAT® frame consists of one or several EtherCAT® telegrams, each of which is addressed to individual slaves / storage areas. The telegrams are either transmitted directly in the data area of the Ethernet frame or in the data area of the UDP datagram. An EtherCAT® telegram consists of an EtherCAT® header, the data area and the work counter (WC). The work counter is incremented by each addressed EtherCAT® slave that exchanged the corresponding data.

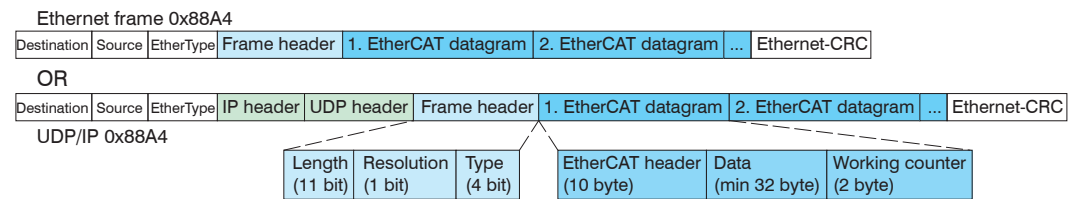

Fig. 47 Setup of EtherCAT frames

A 5.1.2 EtherCAT® Services

In EtherCAT® services for the reading and writing of data are specified in the physical memory of the slave hardware. The following EtherCAT® services are supported by the slave hardware:

- APRD (Autoincrement physical read, Reading of a physical area with auto-increment addressing)
- APWR (Autoincrement physical write, Writing of a physical area with auto-increment addressing)
- APRW (Autoincrement physical read write, Reading and writing of a physical area with auto-increment addressing)
- FPRD (Configured address read, Reading of a physical area with fixed addressing)
- FPWR (Configured address write, Writing of a physical area with fixed addressing)
- FPRW (Configured address read write, Reading and writing of a physical area with fixed addressing)
- BRD (Broadcast Read, Broadcast Reading of a physical area for all slaves)
- BWR (Broadcast Write, Broadcast Writing of a physical area for all slaves)
- LRD (Logical read, Reading of a logical storage area)
- LWR (Logical write, Writing of a logical storage area)
- LRW (Logical read write, Reading and writing of a logical storage area)
- ARMW (Auto increment physical read multiple write, Reading of a physical area with auto-increment addressing, multiple writing)

- FRMW (Configured address read multiple write, Reading of a physical area with fixed addressing, multiple writing)

A 5.1.3 Addressing and FMMUs

In order to address a slave in the EtherCAT® system, various methods from the master can be used. The DT6530 supports as full slave:

- Position addressing
The slave device is addressed via its physical position in the EtherCAT® segment. The services used for this are APRD, APWR, APRW.
- Node addressing
The slave device is addressed via a configured node address, which was assigned by the master during the commissioning phase. The services used for this are FPRD, FPWR and FPRW.
- Logical addressing
The slaves are not addressed individually; instead, a segment of the segment-wide logical 4-GB address is addressed. This segment can be used by a number of slaves. The services used for this are LRD, LWR and LRW.

The local assignment of physical slave memory addresses and logical segment-wide addresses is implemented via the field bus Memory Management Units (FMMUs). The configuration of the slave FMMUs is implemented by the master. The FMMU configuration contains a start address of the physical memory in the slave, a logical start address in the global address space, length and type of the data, as well as the direction (input or output) of the process data.

A 5.1.4 Sync Manager

Sync Managers serve the data consistency during the data exchange between EtherCAT® master and slaves. Each Sync Manager channel defines an area of the application memory. The DT6530 has four channels:

- Sync-Manager-Channel 0: Sync Manager 0 is used for mailbox write transfers (mailbox from master to slave).
- Sync-Manager-Channel 1: Sync Manager 1 is used for mailbox read transfers (mailbox from slave to master).
- Sync-Manager-Channel 2: Sync Manager 2 is usually used for process output data. Not used in the sensor.
- Sync-Manager-Channel 3: Sync Manager 3 is used for process input data. It contains the Tx PDOs that are specified by the PDO assignment object 0x1C13 (hex.).

A 5.1.5 EtherCAT State Machine

The EtherCAT® state machine is implemented in each EtherCAT®. Directly after switching on the capaNCDT 6500, the state machine is in the “Initialization” state. In this state, the master has access to the DLL information register of the slave hardware. The mailbox is not yet initialized, i.e. communication with the application (sensor software) is not yet possible. During the transition to the pre-operational state, the Sync Manager channels are configured for the mailbox communication. In the „Pre-Operational“ state, communication via the mailbox is possible, and it can access the object directory and its objects. In this state, no process data communication occurs. During the transition to the „Safe-Operational“ state, the process-data mapping, the Sync Manager channel of the process inputs and the corresponding FMMU are configured by the master. Mailbox communication continues to be possible in the „Safe-Operational“ state. The process data communication runs for the inputs. The outputs are in the „safe“ state. In the „Operational“ state, process data communication runs for the inputs as well as the outputs.

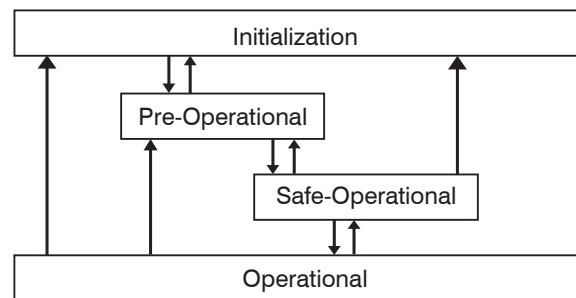

Fig. 48 EtherCAT State Machine

A 5.1.6 CANopen over EtherCAT

The application level communication protocol in EtherCAT is based on the communication profile CANopen DS 301 and is designated either as “CANopen over EtherCAT” or CoE. The protocol specifies the object directory in the sensor, as well as the communication objects for the exchange of process data and acyclic messages. The sensor uses the following message types:

- Process Data Object (PDO). The PDO is used for the cyclic I/O communication, therefore for process data.
- Service Data Object (SDO). The SDO is used for acyclic data transmission.

The object directory is described in the chapter CoE Object Directory.

A 5.1.7 Process Data PDO Mapping

Process Data Objects (PDOs) are used for the exchange of time-critical process data between master and slaves. Tx PDOs are used for the transmission of data from the slaves to the master (inputs), Rx PDOs are used to transmit data from the master to the slaves (outputs); not used in the capaNCDT 6500. The PDO mapping defines which application objects (measurement data) are transmitted into a PDO. The capaNCDT 6500 has a Tx PDO for the measuring data. The following measurements are available as process data:

- Counter Measurement counter (32 Bit)
- Channel 1 Displacement Channel 1
- Channel 2 Displacement Channel 2
- Channel 3 Displacement Channel 3
- Channel 4 Displacement Channel 4
- Channel 5 Displacement Channel 5
- Channel 6 Displacement Channel 6
- Channel 7 Displacement Channel 7
- Channel 8 Displacement Channel 8

A 5.1.8 Service Data SDO Service

Service Data Objects (SDOs) are primarily used for the transmission of data that are not time critical, e.g. parameter values. EtherCAT specifies the SDO services as well as the SDO information services: SDO services make possible the read/write access to entries in the CoE object directory of the device. SDO information services make it possible to read the object directory itself and to access the properties of the objects. All parameters of the measuring device can be read or changed in this way, or measurements can be transmitted. A desired parameter is addressed via index and subindex within the object directory.

A 5.2 CoE – Object Directory

The CoE object directory (CANopen over EtherCAT) contains all the configuration data of the sensor. The objects in CoE object directory can be accessed using the SDO services. Each object is addressed using a 16-bit index.

A 5.2.1 Communication Specific Standard Objects (CiA DS-301)

Overview		
Index (h)	Name	Description
1000	Device type	Device type
1001	Error register	Error register
1008	Device name	Manufacturer device name
1009	Hardware version	Hardware version
100A	Software version	Software version
1018	Identity	Device identification
1A00	TxPDO Mapping	TxPDO Mapping
1C00	Sync. manager type	Sync. manager type
1C13	TxPDO assign	TxPDO assign

Object 1000h: Device type

1000	VAR	Device type	0x00200000	Unsigned32	ro
------	-----	-------------	------------	------------	----

Provides information about the used device profile and the device type.

Object 1001h: Error register

1001	VAR	Error register	0x00	Unsigned8	ro
------	-----	----------------	------	-----------	----

Object 1008h: Manufacturer device name

1008	VAR	Device name	DT6530	Visible String	ro
------	-----	-------------	--------	----------------	----

Object 1009h: Hardware version

1009	VAR	Hardware version	V x.xxx	Visible String	ro
------	-----	------------------	---------	----------------	----

Object 100Ah: Software version

100A	VAR	Software version	V x.xxx	Visible String	ro
------	-----	------------------	---------	----------------	----

Object 1018h: Device identification

1018	RECORD	Identity			
------	--------	----------	--	--	--

Subindices

0	VAR	Number of entries	4	Unsigned8	ro
1	VAR	Vendor ID	0x0000065E	Unsigned32	ro
2	VAR	Product code	0x003EDE73	Unsigned32	ro
3	VAR	Revision	0x00010000	Unsigned32	ro
4	VAR	Serial number	0x009A4435	Unsigned32	ro

The article number is deposit in the product code, the serial number of the sensor in serial number.

Object 1A00h: TxPDO Mapping

1A00	RECORD	TxPDO Mapping			
Subindices					
0	VAR	Number of entries	10	Unsigned8	ro
1	VAR	Subindex 001	0x0000:00	Unsigned32	ro
2	VAR	Subindex 002	0x6020:03	Unsigned32	ro
3	VAR	Subindex 003	0x6020:08	Unsigned32	ro
3	VAR	Subindex 004	0x6020:09	Unsigned32	ro
4	VAR	Subindex 005	0x6020:0A	Unsigned32	ro
6	VAR	Subindex 006	0x6020:0B	Unsigned32	ro
7	VAR	Subindex 007	0x6020:0C	Unsigned32	ro
8	VAR	Subindex 008	0x6020:0D	Unsigned32	ro
9	VAR	Subindex 009	0x6020:0E	Unsigned32	ro
10	VAR	Subindex 0010	0x6020:0F	Unsigned32	ro

Object 1C13h: TxPDO assign

1C13	RECORD	TxPDO assign			
Subindices					
0	VAR	Number of entries	1	Unsigned8	ro
1	VAR	Subindex 001	0x1A00	Unsigned16	ro

A 5.2.2 Manufacturer Specific Objects**Overview**

Index (h)	Name	Description
2010	Controller info	Controller information
2020	Channel 1 Info	Information and settings of channel 1
2021	Channel 2 Info	Information and settings of channel 2
2022	Channel 3 Info	Information and settings of channel 3
2023	Channel 4 Info	Information and settings of channel 4
2024	Channel 5 Info	Information and settings of channel 5
2025	Channel 6 Info	Information and settings of channel 6
2026	Channel 7 Info	Information and settings of channel 7
2027	Channel 8 Info	Information and settings of channel 8
2060	Controller Settings	Controller settings
2100	Controller Interface	Ethernet/EtherCAT settings
2200	Commands	Commands
6020	Measuring values	Measuring values

Object 2010h: Controller information

2010	RECORD	Controller info			ro
------	--------	-----------------	--	--	----

Subindices

0	VAR	Number of entries	5	Unsigned8	ro
1	VAR	Name	DT6530	Visible String	ro
2	VAR	Serial No	xxxxxxx	Unsigned32	ro
3	VAR	Article No	xxxxxxx	Unsigned32	ro
4	VAR	Option No	xxx	Unsigned32	ro
5	VAR	Firmware version	xxx	Visible String	ro

Object 2020h: Channel information

2020	RECORD	Channel 1 info			ro
------	--------	----------------	--	--	----

Subindices

0	VAR	Number of entries	16	Unsigned8	ro
1	VAR	Name	DL6500	Visible String	ro
2	VAR	Serial No	xxxxxxx	Unsigned32	ro
5	VAR	Status	Active	Enum	ro
7	VAR	Range	100	Unsigned32	rw
8	VAR	Unit	μm	Enum	ro
11	VAR	Data format zero value	0	Signed32	ro
12	VAR	Data format end value	16777215	Signed32	ro
16	VAR	Linearization	Off	Enum	ro

The structure of objects 2021h to 2027h corresponds to the object 2020h.

Object 2060h: Controller settings

2060	RECORD	Controller Settings			ro
------	--------	---------------------	--	--	----

Subindices

0	VAR	Number of entries	4	Unsigned8	ro
1	VAR	Samplerate	2083.3 Hz	Enum	rw
2	VAR	Averaging type	Off	Enum	rw
3	VAR	Averaging number	2	Enum	rw
4	VAR	Trigger	Off	Enum	rw

Object 2100h: Controller interface

2100	RECORD	Controller Interface			ro
------	--------	----------------------	--	--	----

Subindices

0	VAR	Number of entries	7	Unsigned8	ro
1	VAR	Ethernet/EtherCAT	EtherCAT	Enum	rw
3	VAR	Ethernet Adress type	Static	Enum	rw
4	VAR	Ethernet IPAddress	169.254.168.150	Visible String	rw
5	VAR	Ethernet Subnet	255.255.0.0	Visible String	rw
6	VAR	Ethernet Gateway	169.254.168.1	Visible String	rw
7	VAR	Ethernet Dataport	10001	Unsigned16	rw

Object 2200h: Commands

2200	RECORD	Commands			ro
------	--------	----------	--	--	----

Subindices

0	VAR	Number of entries	2	Unsigned8	ro
1	VAR	Command	AVT1	Visible String	rw
2	VAR	Command Response	AVT1OK	Visible String	ro

Any commands can be sent to the controller with the object 2200h, for example, the math functions as these are not defined in the COE objects.

Object 6020h: Measuring values

6020	RECORD	Measuring values			ro
------	--------	------------------	--	--	----

Subindices

0	VAR	Number of entries	15	Unsigned8	ro
3	VAR	Counter	xxxx	Signed32	ro
8	VAR	Channel 1	xxxx	Signed32	ro
9	VAR	Channel 2	xxxx	Signed32	ro
10	VAR	Channel 3	xxxx	Signed32	ro
11	VAR	Channel 4	xxxx	Signed32	ro
12	VAR	Channel 5	xxxx	Signed32	ro
13	VAR	Channel 6	xxxx	Signed32	ro
14	VAR	Channel 7	xxxx	Signed32	ro
15	VAR	Channel 8	xxxx	Signed32	ro

A 5.3 Measurement Data Format

The measuring values are transmitted as Signed32.

Since the controller has a resolution of 24 bit, not all 32 bits are required. 0x0 = 0 % of measuring range corresponds consequently to 0xFFFFFFFF = 100 % of measuring range.

The measuring range can be read from the channel info objects 2020h to 2027h (range and unit). Here is also the minimum and maximum value, which the Signed32 measuring value can take (data format zero value and data format end value).

A 5.4 EtherCAT Configuration with the Beckhoff TwinCAT®-Manager

For example the Beckhoff TwinCAT Manager can be used as EtherCAT Master.

- Copy the device description file (EtherCAT®-Slave Information) `Micro-Epsilon.xml` in the directory `\\TwinCAT\IO\EtherCAT` before the measuring device can be configured via EtherCAT®.

The file is available online at:

https://www.micro-epsilon.com/download/software/Micro-Epsilon_EtherCAT_ESI-File.zip.

EtherCAT®-Slave information files are XML files, which specify the characteristics of the Slave device for the EtherCAT® Master and contain information to the supported communication objects.

- Restart the TwinCAT Manager after copying.

Searching for a device:

- Select the tab `I/O Devices`, then `Scan Devices`.
- Confirm with `OK`.

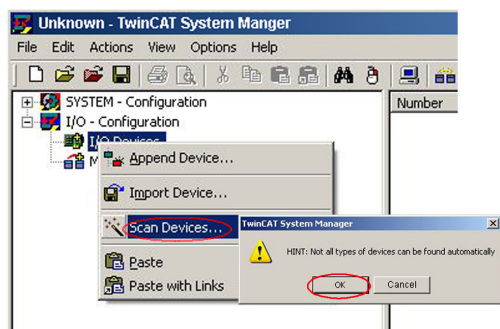

- Select a network card, where EtherCAT®-Slaves should be searching for.



- Confirm with `OK`.

The window `Search for new boxes (EtherCAT®-Slaves)` appears.

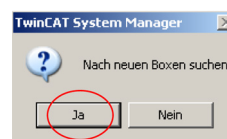

- Confirm with `Yes`.

The DT6530 is now shown in a list.

- Now confirm the window `Activate Free Run` with `Yes`.

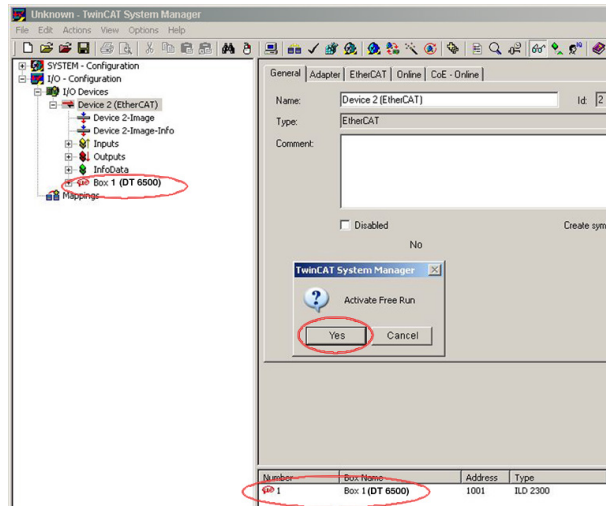

The current status should be at least PREOP, SAFEOP or OP on the Online side.

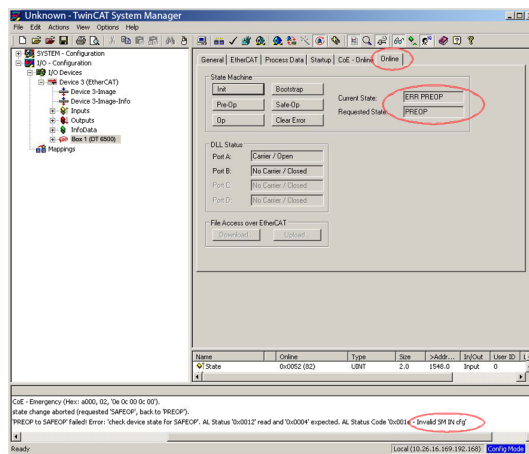

Example for a complete object directory (subject to change without prior notice).

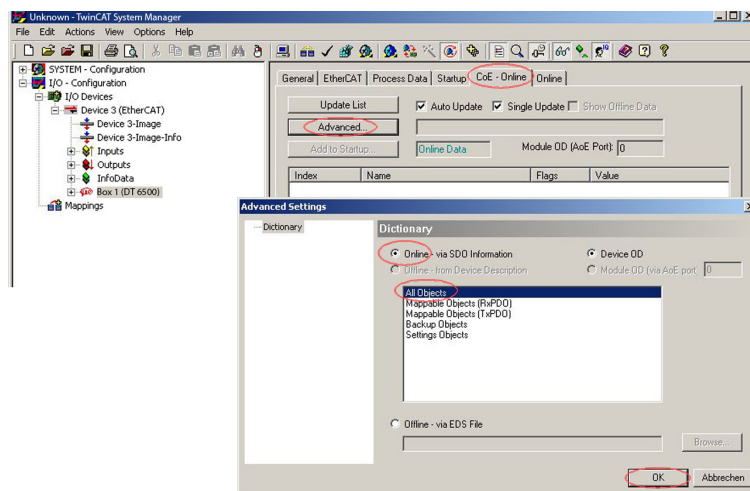

On the Process data side the PDO allocations can be read from the device.

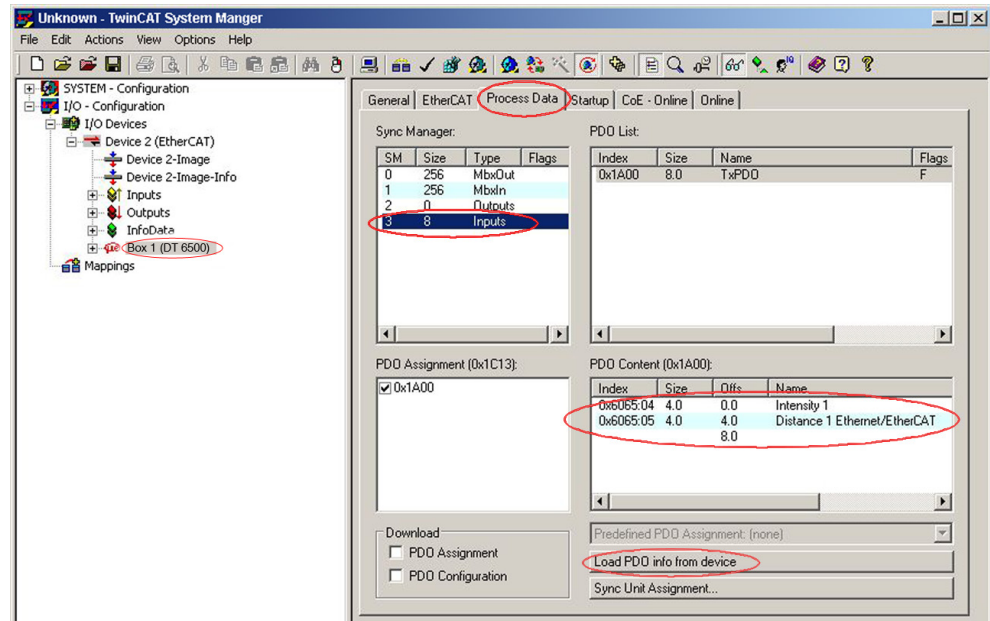

The selected measuring values are transmitted as process data in the status `SAFEOP` and `OP`.

Name	Online		Typ	Größe	>Adre...	Einj/...	User...
Counter	X	0x00121892 (1185...	DINT	4.0	41.0	Eingang	0
Sensor 1		0x008194CD (8492...	DINT	4.0	45.0	Eingang	0
Sensor 2		0x008194CD (8492...	DINT	4.0	49.0	Eingang	0
Sensor 3		0x00000000 (0)	DINT	4.0	53.0	Eingang	0
Sensor 4		0x00000000 (0)	DINT	4.0	57.0	Eingang	0

A 6 Thickness Measurement

A 6.1 General

This chapter describes a thickness measurement with two oppositely mounted sensors. The display on controller shows the distance values of the individual sensors. The distance between the two sensors to one another comes as a base into the thickness measurement.

The following description requires,

- that the sensors are connected,
- the power supply at controller is switched on,
- the controller is connected to the network (PC) via Ethernet.

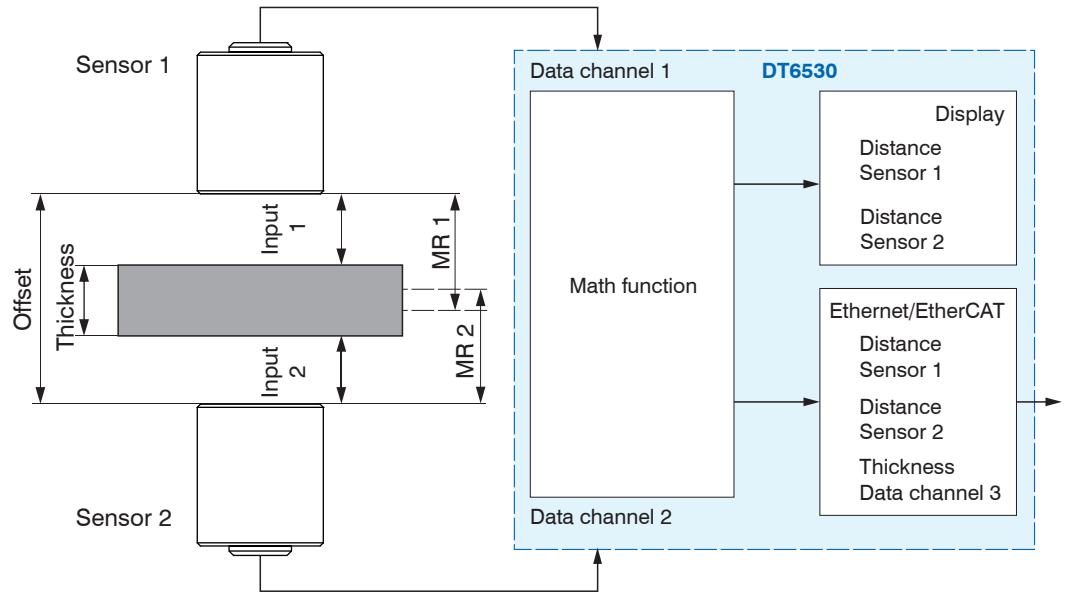
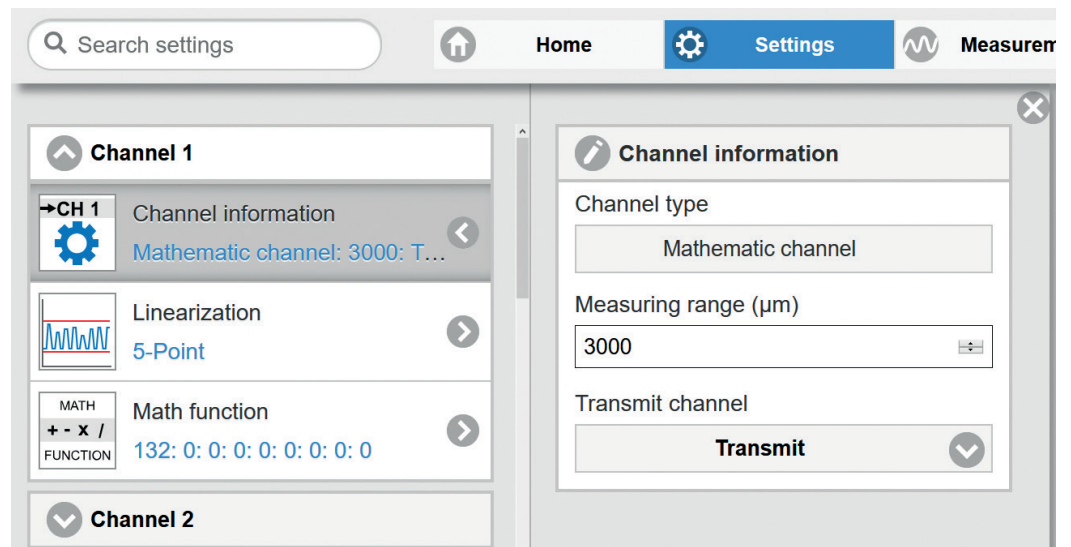

Fig. 49 Measuring principle thickness measurement

MR 1/2: Measuring range sensor 1/2

A 6.2 Define Sensor Measuring Ranges

The controller requires the specification of the individual sensor measuring ranges for an accurate thickness measurement. To do this, use the web interface. In the example below two sensors are used, each with 3 mm measuring range.



- ➡ Change to the menu Settings > Channel n > Channel information > Measuring range.
- ➡ Enter the measuring ranges for sensor 1 (data channel 1) and sensor 2 (data channel 2), each with 3,000 µm. Confirm your input with Transmit.
- ➡ Keep the measuring range for the thickness value (data channel 3) at 10,000 µm.

If no module is on the output channel, the individually set value is overwritten again with 10.000 when the system restarts. If the word length of the data channel is optimally utilized and therefore a smaller measuring range is adjusted, this setting must be reset after the restart.

The measuring ranges are changed automatically in the controller with one another so that the result is output correctly regardless of the measuring range of the output channel.

A 6.3 Data Format, Word Length

	Ethernet	EtherCAT
Word length	24 bit	32 bit
Used word length	21 bit; thus measuring values greater than 100 % can be output at math channels	24 bBit (if necessary, up to 32 bit)
Max. output range	800 % * measuring range	25.600 % * measuring range
Example	Expected thickness value = 4.000 μm min. measuring range = 500 μm (= 1/8 of the max. expectancy value)	Expected thickness value = 128.000 μm min. measuring range = 500 μm

However, there are still a few things to consider:

- The measuring values are stored only in channels, where there is also a demodulator module. In case of empty channels, the measuring range is always set to a default value of 10.000 μm after a restart. That means, here you should not enter other measuring range, since otherwise the computed result is wrongly scaled after a restart.

A 6.4 Set Math Functions

➡ Change to menu `Settings > Channel n > Math Function`.

The screenshot shows the 'Settings' menu for 'Channel 3'. The 'Math function' section is active, showing the following configuration:

- Offset (μm): 4000
- + Measurement channel 1 \times : -1
- + Measurement channel 2 \times : -1
- + Measurement channel 3 \times : (empty)

- ➡ Select the data channel on which the thickness value is to be output; in the example here, this is data channel 3.
- ➡ Enter the offset (distance between the two sensors to one another). In this example here, the offset is 4.000 μm .
- ➡ Give the value 1 as a factor for the measuring channel 1/2.
- ➡ Confirm the input(s) with `Set math function`.

Formula for the thickness measurement:

$$\text{Data channel} = \text{Offset} + \text{Measuring channel 1} + \text{Measuring channel 2}$$

The result of the mathematic function is output via the Ethernet interface. It is not shown on display of the DD6530. The output as analog signal is possible via the optional available analog output card DO6510, see 5.2.3 or EtherCAT and an appropriate output terminal.

Do not change the measuring range of the output channel subsequently, since the entered offset of the mathematic function refers to this measuring range and this is not changed automatically. Otherwise you must enter again the mathematic function.

If you do not use the Web interface, you can work with the Ethernet commands, e.g. set mathematic function „SMF“, see 6.4.16.

Note that the offset based on the measuring range of the output channel must be input here.

Example: Offset 4,000 μm, measuring range of the output channel 10,000 μm. Thus correspond 10,000 μm = 0x3FFFFFF and the offset of 4,000 μm = 0x199999

A 6.5 Interpretation of the Measuring Values

During the Ethernet transmission the data format reduces from 24 bit to 21 bit. Thus 0x3FFFFFF corresponds 100 % of the measuring range (of output channel), in the example 10,000 μm.

During the EtherCAT transmission the data format does not reduce to 21 bit. Thus 0xFFFFFFFF corresponds 100 % of the measuring range (of output channel), in the example 10,000 μm.

A 6.6 Example

Sensor measuring range to small

$$MR\ 1 + MR\ 2 < Offset$$

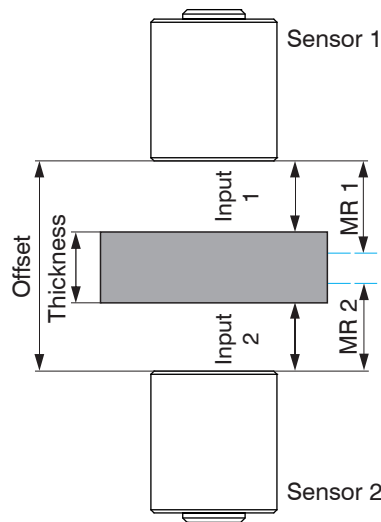

MR 1/2: Measuring range sensor 1/2

Distance of the sensors to each other is too large or thickness measurement is not always possible at target vibration.

Measuring range overlap

$$MR\ 1 + MR\ 2 > Offset$$

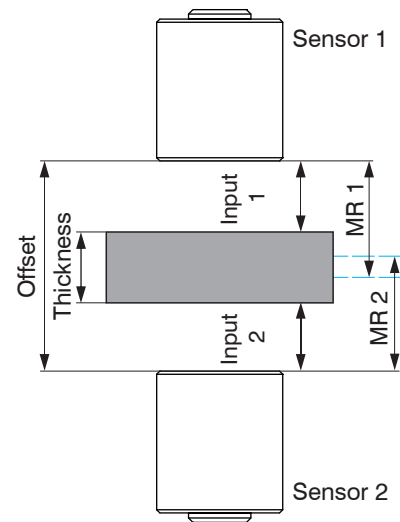

Thickness measurement even possible at a low target vibration.

The double-sided thickness measurement gets along without complex target layer. The main advantage is that vibrations of the target do not lead to a measurement uncertainty if offset and measuring ranges of sensors are well chosen.

The position tolerance of the target is determined from the offset and measuring range (MR) of sensors.

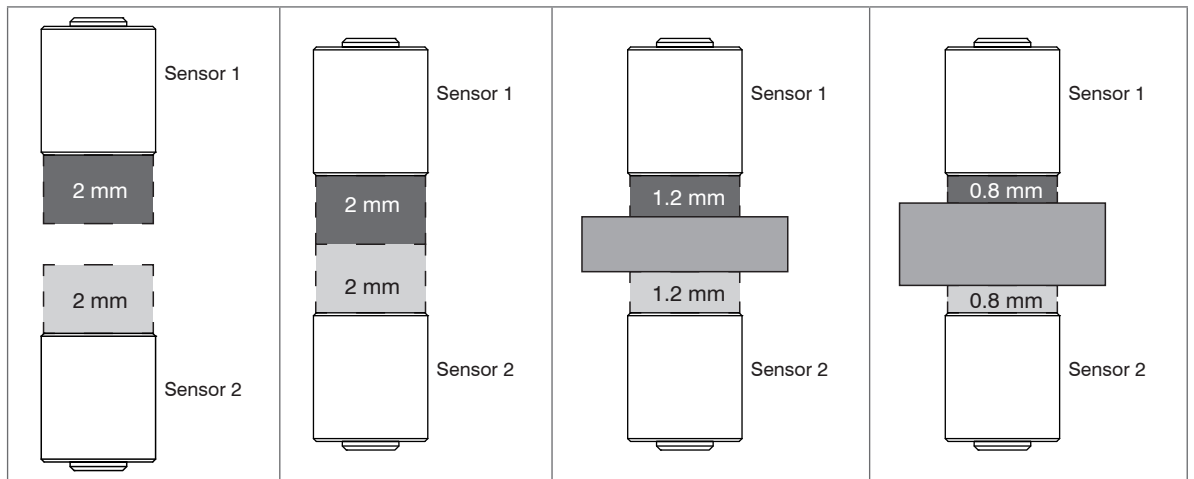

Offset	5,200 μm	4,000 μm	4,000 μm	4,000 μm
Measuring range sensors	2,000 μm	2,000 μm	2,000 μm	2,000 μm
Target thickness	wrong, distance to large	0 μm (no target)	1,600 μm	2,400 μm

